

MM3Z2V0~MM3Z75

Silicon Planar Zener Diodes

Features

- Total power dissipation : max. 300 mW
- Small plastic package suitable for surface mounted design
- Tolerance approximately $\pm 5\%$

PINNING

PIN	DESCRIPTION
1	Cathode
2	Anode

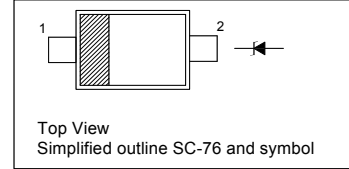

Absolute Maximum Ratings ($T_a = 25^\circ\text{C}$)

Parameter	Symbol	Value	Unit
Power Dissipation	P_{tot}	300	mW
Junction Temperature	T_j	150	$^\circ\text{C}$
Storage Temperature Range	T_{stg}	- 55 to + 150	$^\circ\text{C}$

Characteristics at $T_a = 25^\circ\text{C}$

Parameter	Symbol	Max.	Unit
Thermal Resistance Junction to Ambient Air	$R_{\theta\text{JA}}$	417	$^\circ\text{C/W}$
Forward Voltage at $I_F = 10\text{ mA}$	V_F	0.9	V



SEMTECH ELECTRONICS LTD.



ISO/TS 16949 : 2009
Certificate No. 160713000



ISO14001 : 2004
Certificate No. 7116



ISO 9001 : 2008
Certificate No. 90719410



BS-OHSAS 18001 : 2007
Certificate No. 7116



IECQ QC 080000
Certificate No. PRC-HSPM-1485-1

Dated: 16/03/2015 Rev: 01

MM3Z2V0~MM3Z75

Characteristics at $T_a = 25\text{ }^\circ\text{C}$

Type	Marking Code	Zener Voltage Range ¹⁾			Dynamic Impedance		Reverse Leakage Current	
		V_{znom} (V)	V_{ZT} (V)	at I_{ZT} (mA)	Z_{ZT} Max. (Ω)	at I_{ZT} (mA)	I_R Max. (μA)	at V_R (V)
MM3Z2V0	B0	2.0	1.8...2.15	5	100	5	120	0.5
MM3Z2V2	C0	2.2	2.08...2.33	5	100	5	120	0.7
MM3Z2V4	1C	2.4	2.28...2.56	5	100	5	120	1
MM3Z2V7	1D	2.7	2.5...2.9	5	110	5	120	1
MM3Z3V0	1E	3.0	2.8...3.2	5	120	5	50	1
MM3Z3V3	1F	3.3	3.1...3.5	5	130	5	20	1
MM3Z3V6	1H	3.6	3.4...3.8	5	130	5	10	1
MM3Z3V9	1J	3.9	3.7...4.1	5	130	5	5	1
MM3Z4V3	1K	4.3	4...4.6	5	130	5	5	1
MM3Z4V7	1M	4.7	4.4...5	5	130	5	2	1
MM3Z5V1	1N	5.1	4.8...5.4	5	130	5	2	1.5
MM3Z5V6	1P	5.6	5.2...6	5	80	5	1	2.5
MM3Z6V2	1R	6.2	5.8...6.6	5	50	5	1	3
MM3Z6V8	1X	6.8	6.4...7.2	5	30	5	0.5	3.5
MM3Z7V5	1Y	7.5	7...7.9	5	30	5	0.5	4
MM3Z8V2	1Z	8.2	7.7...8.7	5	30	5	0.5	5
MM3Z9V1	2A	9.1	8.5...9.6	5	30	5	0.5	6
MM3Z10	2B	10	9.4...10.6	5	30	5	0.1	7
MM3Z11	2C	11	10.4...11.6	5	30	5	0.1	8
MM3Z12	2D	12	11.4...12.7	5	35	5	0.1	9
MM3Z13	2E	13	12.4...14.1	5	35	5	0.1	10
MM3Z15	2F	15	13.8...15.6	5	40	5	0.1	11
MM3Z16	2H	16	15.3...17.1	5	40	5	0.1	12
MM3Z18	2J	18	16.8...19.1	5	45	5	0.1	13
MM3Z20	2K	20	18.8...21.2	5	50	5	0.1	15
MM3Z22	2M	22	20.8...23.3	5	55	5	0.1	17
MM3Z24	2N	24	22.8...25.6	5	60	5	0.1	19
MM3Z27	2P	27	25.1...28.9	2	70	2	0.1	21
MM3Z30	2R	30	28...32	2	80	2	0.1	23
MM3Z33	2X	33	31...35	2	80	2	0.1	25
MM3Z36	2Y	36	34...38	2	90	2	0.1	27
MM3Z39	2Z	39	37...41	2	100	2	0.1	30
MM3Z43	3A	43	40...46	2	130	2	0.1	33
MM3Z47	3B	47	44...50	2	150	2	0.1	36
MM3Z51	3C	51	48...54	2	180	2	0.1	39
MM3Z56	3D	56	52...60	2	200	2	0.1	43
MM3Z62	3E	62	58...66	2	215	2	0.1	47
MM3Z68	3F	68	64...72	2	240	2	0.1	52
MM3Z75	3H	75	70...79	2	265	2	0.1	56

¹⁾ V_{ZT} is tested with pulses (20 ms).



SEMTECH ELECTRONICS LTD.



Dated: 16/03/2015 Rev: 01

MM3Z2V0~MM3Z75

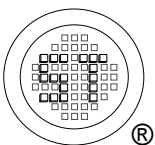
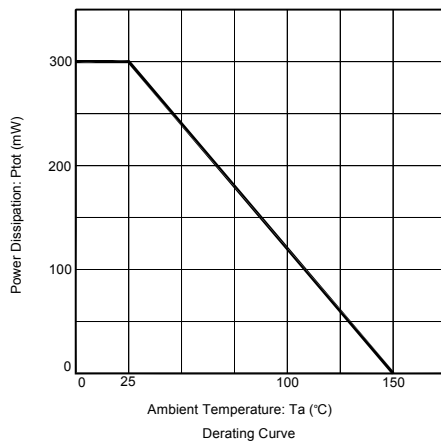
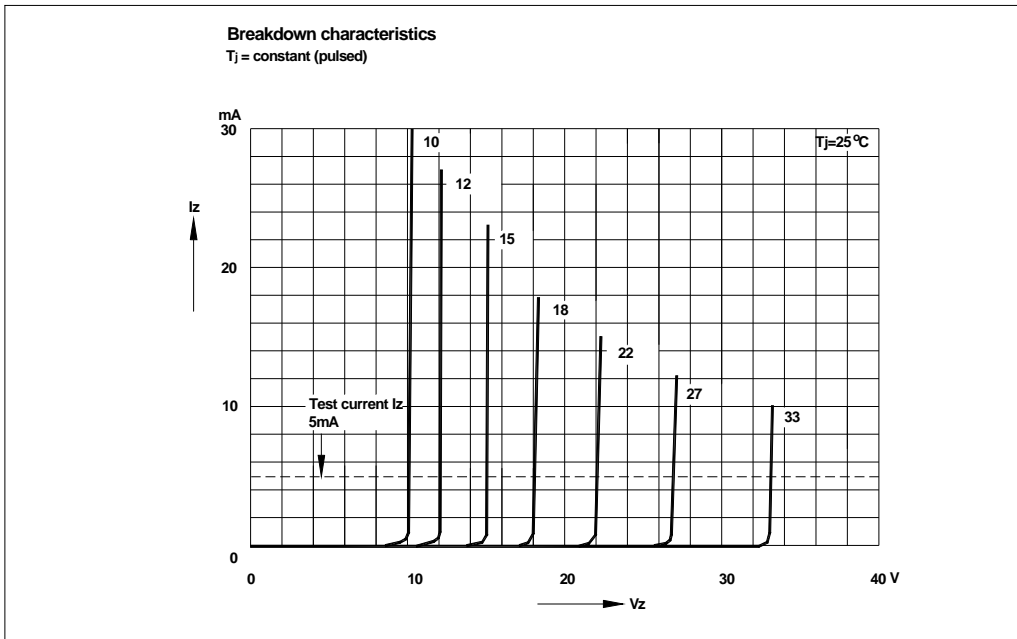
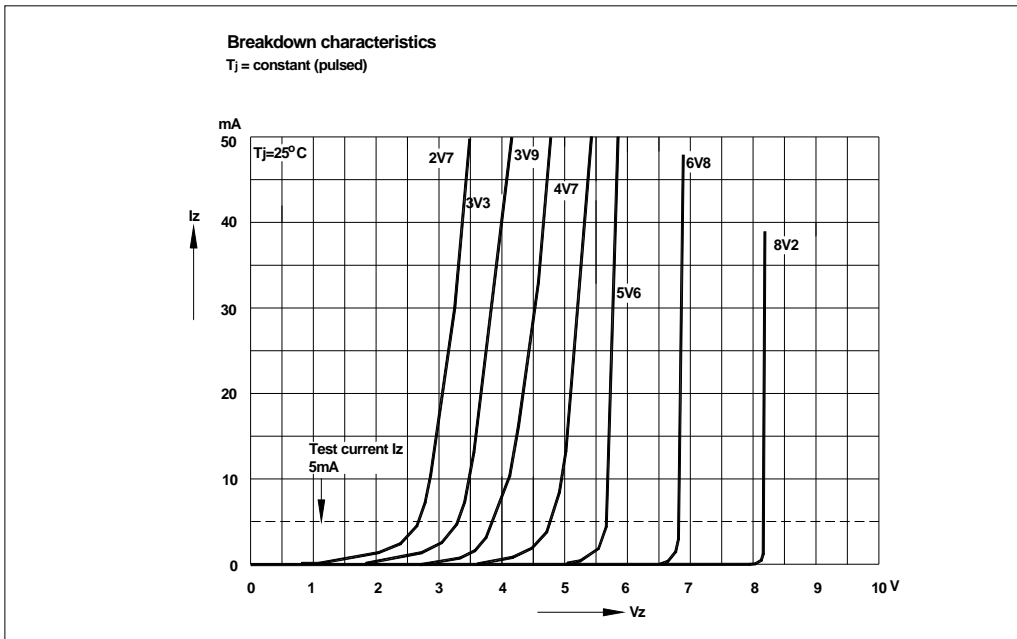

SEMTECH ELECTRONICS LTD.



ISO/TS 16949 : 2009
Certificate No. 160713000



ISO14001 : 2004
Certificate No. 7116



ISO 9001 : 2008
Certificate No. 50719410



BS-OHSAS 18001 : 2007
Certificate No. 7116



IECQ QC 080000
Certificate No. PRC-HSPM-1485-1

Dated: 16/03/2015 Rev: 01

MM3Z2V0~MM3Z75

PACKAGE OUTLINE

Plastic surface mounted package; 2 leads

SC-76

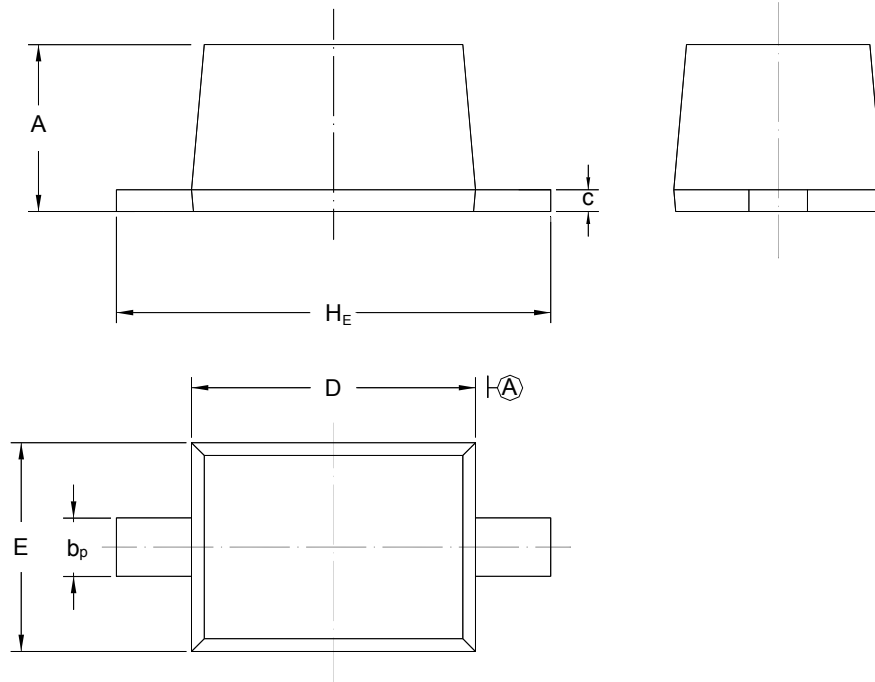

UNIT	A	b _p	C	D	E	H _E
mm	1.10 0.80	0.40 0.25	0.15 0.10	1.80 1.60	1.35 1.15	2.80 2.30

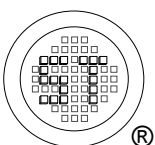

SEMTECH ELECTRONICS LTD.



ISO/TS 16949 : 2009
Certificate No. 160713000



ISO14001 : 2004
Certificate No. 7116



ISO 9001 : 2008
Certificate No. 50719410



BS-OHSAS 18001 : 2007
Certificate No. 7116



IECQ QC 080000
Certificate No. PRC-18P16-148-1

Dated: 16/03/2015 Rev: 01

X-ON Electronics

Largest Supplier of Electrical and Electronic Components

Click to view similar products for [Zener Diodes](#) category:

Click to view products by [Semtech](#) manufacturer:

Other Similar products are found below :

[RKZ13B2KG#P1](#) [DL5234B](#) [EDZTE6113B](#) [1N4682](#) [1N4691](#) [1N4693](#) [1N4732A](#) [1N4736A](#) [1N4750A](#) [1N4759ARL](#) [1N5241B](#) [1N5365B](#)
[1N5369B](#) [1N747A](#) [1N959B](#) [1N964B](#) [1N966B](#) [1N968B](#) [1N972B](#) [NTE5121A](#) [NTE5147A](#) [NTE5152A](#) [NTE5155A](#) [NTE5164A](#)
[JANS1N4974US](#) [1N4692](#) [1N4700](#) [1N4702](#) [1N4704](#) [1N4711](#) [1N4714](#) [1N4737A](#) [1N4745ARL](#) [1N4752A](#) [1N4752ARL](#) [1N4760ARL](#)
[1N5221B](#) [1N5236B](#) [1N5241BTR](#) [1N5242BTR](#) [1N5350B](#) [1N5352B](#) [1N961BRR1](#) [1N964BRL](#) [RKZ5.1BKU#P6](#) [3SMAJ5946B-TP](#)
[3SMAJ5950B-TP](#) [3SMBJ5925B-TP](#) [441774C](#) [BZX84C3V9](#)