

# MM3Z2V2B~MM3Z39B

## Silicon Planar Zener Diodes

### Features

- Total power dissipation: max. 300 mW
- Small plastic package suitable for surface mounted design
- High reliability

### Description

Silicon planar Zener diode in a small plastic SMD SOD-323 package

### PINNING

PIN	DESCRIPTION
1	Cathode
2	Anode

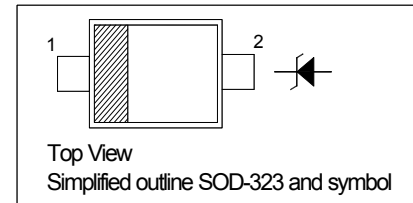

### Absolute Maximum Ratings ( $T_a = 25^\circ\text{C}$ )

Parameter	Symbol	Value	Unit
Power Dissipation	$P_{\text{tot}}$	300	mW
Junction Temperature	$T_j$	150	$^\circ\text{C}$
Storage Temperature Range	$T_{\text{Stg}}$	- 55 to + 150	$^\circ\text{C}$

### Characteristics at $T_a = 25^\circ\text{C}$

Parameter	Symbol	Max.	Unit
Thermal Resistance Junction to Ambient Air <sup>1)</sup>	$R_{\text{thA}}$	417	$^\circ\text{C}/\text{W}$

<sup>1)</sup> Device mounted on FR-4 substrate PC board, 2oz copper, with minimum recommended pad layout.

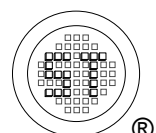

# MM3Z2V2B~MM3Z39B

Characteristics at  $T_a = 25^\circ\text{C}$  ( $V_F = 0.9\text{ V Max. at } I_F = 10\text{ mA}$ )

Type	Marking Code	Zener Voltage Range <sup>1)</sup>			Dynamic Impedance <sup>2)</sup>		Reverse Leakage Current	
		$V_{ZT}$		$I_{ZT}$	$Z_{ZT}(\text{Max.})$	at $I_{ZT}$	$I_R(\text{Max.})$	at $V_R$
		Min.(V)	Max.(V)	mA	$\Omega$	mA	$\mu\text{A}$	V
MM3Z2V2B	MF	2.1	2.4	5	100	5	120	0.7
MM3Z2V4B	7C	2.3	2.65	5	100	5	120	1
MM3Z2V7B	7D	2.65	2.95	5	110	5	120	1
MM3Z3V0B	7E	2.95	3.25	5	120	5	50	1
MM3Z3V3B	7F	3.25	3.55	5	120	5	20	1
MM3Z3V6B	7H	3.6	3.845	5	100	5	10	1
MM3Z3V9B	7J	3.89	4.16	5	100	5	5	1
MM3Z4V3B	7K	4.17	4.43	5	100	5	5	1
MM3Z4V7B	7M	4.55	4.75	5	100	5	2	1
MM3Z5V1B	7N	4.98	5.2	5	80	5	2	1.5
MM3Z5V6B	7P	5.49	5.73	5	60	5	1	2.5
MM3Z6V2B	7R	6.06	6.33	5	60	5	1	3
MM3Z6V8B	7X	6.65	6.93	5	40	5	0.5	3.5
MM3Z7V5B	7Y	7.28	7.6	5	30	5	0.5	4
MM3Z8V2B	7Z	8.02	8.36	5	30	5	0.5	5
MM3Z9V1B	8A	8.85	9.23	5	30	5	0.5	6
MM3Z10B	8B	9.77	10.21	5	30	5	0.1	7
MM3Z11B	8C	10.76	11.22	5	30	5	0.1	8
MM3Z12B	8D	11.74	12.24	5	30	5	0.1	9
MM3Z13B	8E	12.91	13.49	5	37	5	0.1	10
MM3Z15B	8F	14.34	14.98	5	42	5	0.1	11
MM3Z16B	8H	15.85	16.51	5	50	5	0.1	12
MM3Z18B	8J	17.56	18.35	5	65	5	0.1	13
MM3Z20B	8K	19.52	20.39	5	85	5	0.1	15
MM3Z22B	8M	21.54	22.47	5	100	5	0.1	17
MM3Z24B	8N	23.72	24.78	5	120	5	0.1	19
MM3Z27B	8P	26.19	27.53	5	150	5	0.1	21
MM3Z30B	8R	29.19	30.69	5	200	5	0.1	23
MM3Z33B	8X	32.15	33.79	5	250	5	0.1	25
MM3Z36B	8Y	35.07	36.87	5	300	5	0.1	27
MM3Z39B	8Z	37	41	5	100	5	2	30

<sup>1)</sup>  $V_Z$  is tested with pulses (20 ms).

<sup>2)</sup>  $Z_{ZT}$  is measured at  $I_Z$  by given a very small A.C. current signal.

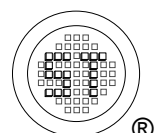

# MM3Z2V2B~MM3Z39B

## Electrical Characteristics Curves

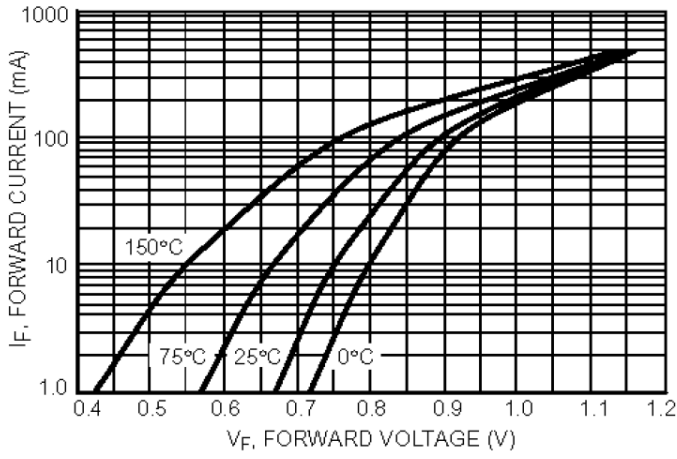

Breakdown characteristics  
 $T_J = \text{constant (pulsed)}$

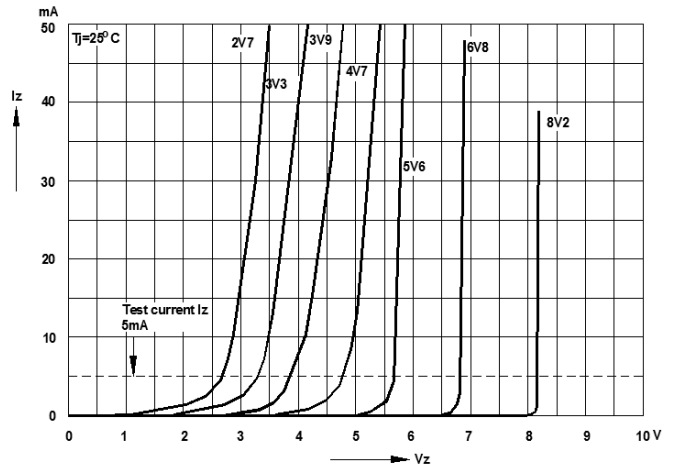

Breakdown characteristics  
 $T_J = \text{constant (pulsed)}$

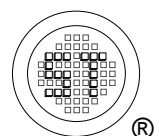
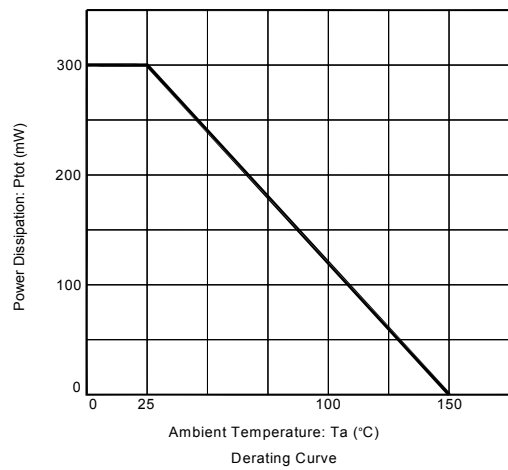
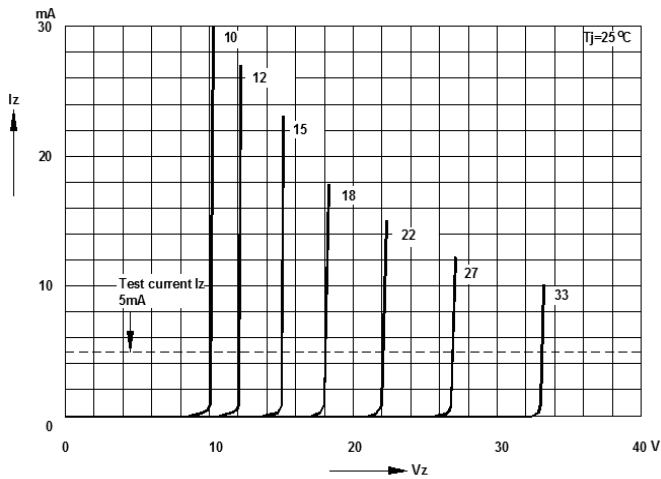

# MM3Z2V2B~MM3Z39B

## PACKAGE OUTLINE

Plastic surface mounted package; 2 leads

SOD-323

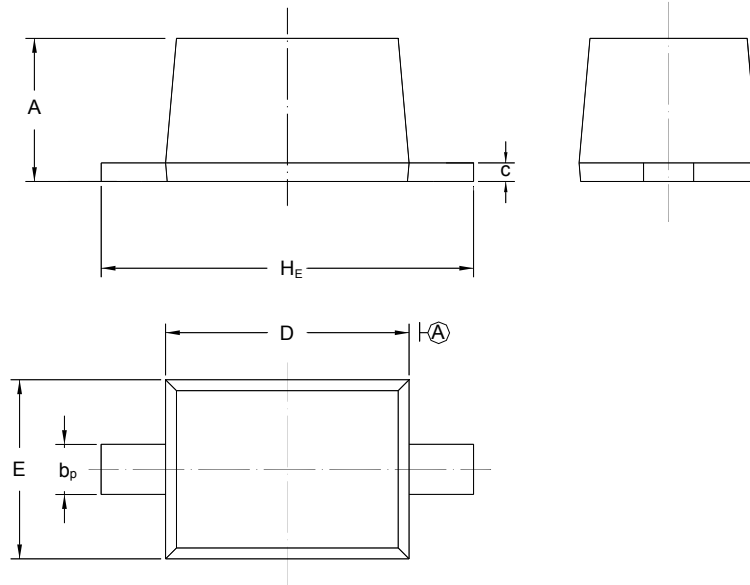

UNIT	A	b <sub>p</sub>	C	D	E	H <sub>E</sub>
mm	1.10 0.80	0.40 0.25	0.15 0.10	1.80 1.60	1.35 1.15	2.80 2.30

## Recommended Soldering Footprint

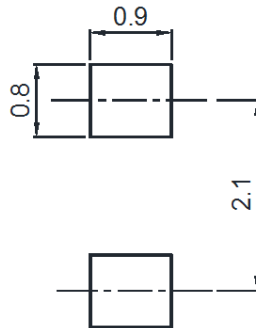

## Packing information

Package	Tape Width (mm)	Pitch		Reel Size		Per Reel Packing Quantity
		mm	inch	mm	inch	
SOD-323	8	4 ± 0.1	0.157 ± 0.004	178	7	3,000

## Marking information

" III " = Cathode line

" \*\* " = Part No.

Font type: Arial

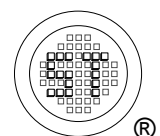

## X-ON Electronics

Largest Supplier of Electrical and Electronic Components

*Click to view similar products for [Zener Diodes](#) category:*

*Click to view products by [Semtech](#) manufacturer:*

Other Similar products are found below :

[RKZ13B2KG#P1](#) [DL5234B](#) [EDZTE6113B](#) [1N4682](#) [1N4693](#) [1N4732A](#) [1N4736A](#) [1N4750A](#) [1N4759ARL](#) [1N5241B](#) [1N5365B](#) [1N5369B](#)  
[1N747A](#) [1N964B](#) [1N966B](#) [1N968B](#) [1N972B](#) [JANS1N4974US](#) [JANTX1N5907](#) [1N4692](#) [1N4700](#) [1N4702](#) [1N4704](#) [1N4711](#) [1N4714](#)  
[1N4745ARL](#) [1N4752ARL](#) [1N4760ARL](#) [1N5221B](#) [1N5242BTR](#) [1N5350B](#) [1N5352B](#) [1N961BRR1](#) [1N964BRL](#) [RKZ5.1BKU#P6](#)  
[3SMAJ5946B-TP](#) [3SMAJ5950B-TP](#) [3SMBJ5925B-TP](#) [MMSZ5230BQ-13-F](#) [MMSZ5232BQ-13-F](#) [BZX84C7V5](#) [3SMAJ5945B-TP](#)  
[3SMAJ5947B-TP](#) [3SMBJ5941B-TP](#) [DL4732A-T3](#) [DZ2S240M0L](#) [SMAZ27-TP](#) [ZMM5224B-7](#) [RD16UM-T1-A](#) [RD39S-T1-A](#)