

# MM5Z2V0~MM5Z75

## Silicon Planar Zener Diodes

### Features

- Standard Zener Breakdown Voltage Range  
2.0 V to 75 V
- Steady State Power Rating of 200 mW

### PINNING

PIN	DESCRIPTION
1	Cathode
2	Anode

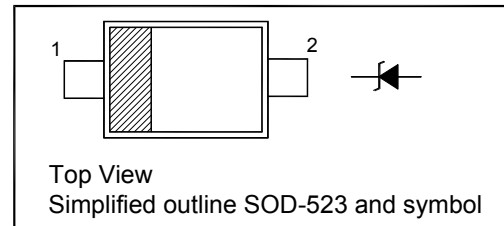

### Absolute Maximum Ratings ( $T_a = 25\text{ }^\circ\text{C}$ )

Parameter	Symbol	Value	Unit
Total Device Dissipation	$P_{tot}$	200	mW
Junction and Storage Temperature Range	$T_j, T_{stg}$	- 65 to + 150	$^\circ\text{C}$

### Characteristics at $T_a = 25\text{ }^\circ\text{C}$

Parameter	Symbol	Max.	Unit
Forward Voltage at $I_F = 10\text{ mA}$	$V_F$	0.9	V

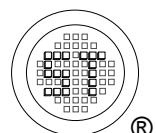

# MM5Z2V0~MM5Z75

Type	Marking Code	Zener Voltage <sup>1)</sup>				Zener Impedance				Leakage Current	
		V <sub>ZT</sub>			at I <sub>ZT</sub>	Z <sub>ZT</sub>	at I <sub>ZT</sub>	Z <sub>ZK</sub>	at I <sub>ZK</sub>	I <sub>R</sub>	at V <sub>R</sub>
		Min. (V)	Nom. (V)	Max. (V)	(mA)	Max. (Ω)	(mA)	Max. (Ω)	(mA)	Max. (μA)	(V)
MM5Z2V0	RD	1.8	2.0	2.15	5	100	5	-	-	120	0.5
MM5Z2V2	RE	2.08	2.2	2.33	5	100	5	-	-	120	0.7
MM5Z2V4	Z7	2.2	2.4	2.6	5	100	5	1000	1	120	1
MM5Z2V7	A8	2.5	2.7	2.9	5	100	5	1000	1	120	1
MM5Z3V0	B8	2.8	3.0	3.2	5	100	5	1000	1	50	1
MM5Z3V3	C8	3.1	3.3	3.5	5	95	5	1000	1	20	1
MM5Z3V6	D8	3.4	3.6	3.8	5	90	5	1000	1	10	1
MM5Z3V9	E8	3.7	3.9	4.1	5	90	5	1000	1	5	1
MM5Z4V3	F8	4	4.3	4.6	5	90	5	1000	1	5	1
MM5Z4V7	G8	4.4	4.7	5	5	80	5	800	1	2	1
MM5Z5V1	H8	4.8	5.1	5.4	5	60	5	500	1	2	1.5
MM5Z5V6	I8	5.2	5.6	6	5	40	5	200	1	1	2.5
MM5Z6V2	J8	5.8	6.2	6.6	5	10	5	100	1	1	3
MM5Z6V8	K8	6.4	6.8	7.2	5	15	5	160	1	0.5	3.5
MM5Z7V5	L8	7	7.5	7.9	5	15	5	160	1	0.5	4
MM5Z8V2	M8	7.7	8.2	8.7	5	15	5	160	1	0.5	5
MM5Z9V1	N8	8.5	9.1	9.6	5	15	5	160	1	0.5	6
MM5Z10	O8	9.4	10	10.6	5	20	5	160	1	0.1	7
MM5Z11	P8	10.4	11	11.6	5	20	5	160	1	0.1	8
MM5Z12	Q8	11.4	12	12.7	5	25	5	80	1	0.1	9
MM5Z13	R8	12.4	13	14.1	5	30	5	80	1	0.1	10
MM5Z15	S8	13.8	15	15.6	5	30	5	80	1	0.1	11
MM5Z16	T8	15.3	16	17.1	2	40	2	80	1	0.1	12
MM5Z18	U8	16.8	18	19.1	2	45	2	80	1	0.1	13
MM5Z20	V8	18.8	20	21.2	2	55	2	100	1	0.1	15
MM5Z22	W8	20.8	22	23.3	2	55	2	100	1	0.1	17
MM5Z24	X8	22.8	24	25.6	2	70	2	120	1	0.1	19
MM5Z27	Y8	25.1	27	28.9	2	80	2	300	1	0.1	21
MM5Z30	Z8	28	30	32	2	80	2	300	1	0.1	23
MM5Z33	A9	31	33	35	2	80	2	300	1	0.1	25
MM5Z36	B9	34	36	38	2	90	2	500	1	0.1	27
MM5Z39	C9	37	39	41	2	130	2	500	1	2	30
MM5Z43	D9	40	43	46	1	150	1	500	1	2	33
MM5Z47	E9	44	47	50	1	170	1	500	1	2	36
MM5Z51	F9	48	51	54	1	180	1	500	1	1	39
MM5Z56	G9	52	56	60	1	200	1	500	1	1	43
MM5Z62	H9	58	62	66	1	215	1	500	1	0.2	47
MM5Z68	I9	64	68	72	1	240	1	500	1	0.2	52
MM5Z75	J9	70	75	79	1	255	1	500	1	0.2	57

<sup>1)</sup> Tested with pulses tp = 20 ms.

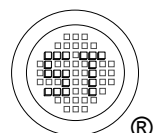

# MM5Z2V0~MM5Z75

---

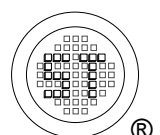
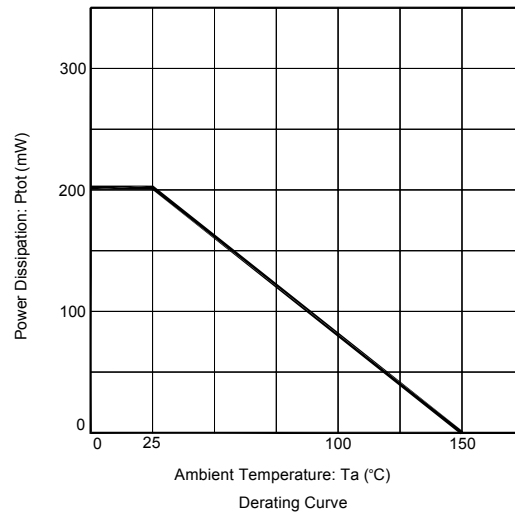

# MM5Z2V0~MM5Z75

## PACKAGE OUTLINE

Plastic surface mounted package; 2 leads

SOD-523

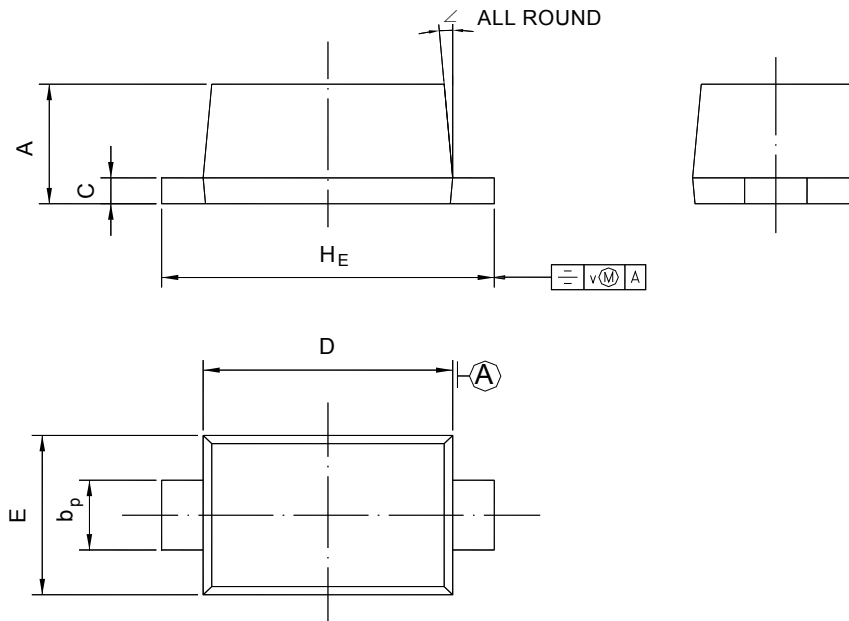

UNIT	A	b <sub>p</sub>	C	D	E	H <sub>E</sub>	V	∠
mm	0.70 0.60	0.4 0.3	0.135 0.100	1.25 1.15	0.85 0.75	1.7 1.5	0.1	5°

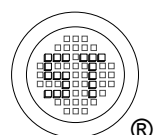

## X-ON Electronics

Largest Supplier of Electrical and Electronic Components

*Click to view similar products for [Zener Diodes](#) category:*

*Click to view products by [Semtech](#) manufacturer:*

Other Similar products are found below :

[RKZ13B2KG#P1](#) [DL5234B](#) [EDZTE6113B](#) [1N4682](#) [1N4693](#) [1N4732A](#) [1N4736A](#) [1N4750A](#) [1N4759ARL](#) [1N5241B](#) [1N5365B](#) [1N5369B](#)  
[1N747A](#) [1N964B](#) [1N966B](#) [1N968B](#) [1N972B](#) [JANS1N4974US](#) [JANTX1N5907](#) [1N4692](#) [1N4700](#) [1N4702](#) [1N4704](#) [1N4711](#) [1N4714](#)  
[1N4745ARL](#) [1N4752ARL](#) [1N4760ARL](#) [1N5221B](#) [1N5242BTR](#) [1N5350B](#) [1N5352B](#) [1N961BRR1](#) [1N964BRL](#) [RKZ5.1BKU#P6](#)  
[3SMAJ5946B-TP](#) [3SMAJ5950B-TP](#) [3SMBJ5925B-TP](#) [MMSZ5230BQ-13-F](#) [MMSZ5232BQ-13-F](#) [BZX84C7V5](#) [3SMAJ5945B-TP](#)  
[3SMAJ5947B-TP](#) [3SMBJ5941B-TP](#) [DL4732A-T3](#) [DZ2S240M0L](#) [SMAZ27-TP](#) [ZMM5224B-7](#) [RD16UM-T1-A](#) [RD39S-T1-A](#)