

# MMFTP84K

## P-Channel Enhancement Mode MOSFET

### Features

- ESD protection

### Applications

- Portable appliances

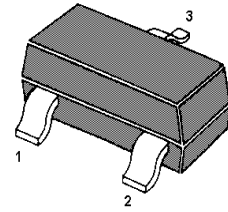
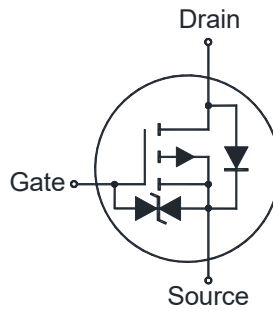

1. Gate 2. Source 3. Drain  
SOT-23 Plastic Package

### Absolute Maximum Ratings (at $T_a = 25^\circ\text{C}$ unless otherwise specified)

Parameter	Symbol	Value	Unit
Drain-Source Voltage	$-V_{DS}$	60	V
Gate-Source Voltage	$V_{GS}$	$\pm 20$	V
Continuous Drain Current	$-I_D$	180	mA
Peak Drain Current, Pulsed <sup>1)</sup>	$-I_{DM}$	700	mA
Power Dissipation <sup>2)</sup>	$P_D$	225	mW
Thermal Resistance from Junction to Ambient	$R_{\theta JA}$	556 <sup>2)</sup> 265 <sup>3)</sup>	$^\circ\text{C/W}$
Operating Junction Temperature Range	$T_j$	- 55 to + 150	$^\circ\text{C}$
Storage Temperature Range	$T_{stg}$	- 55 to + 150	$^\circ\text{C}$

<sup>1)</sup> Pulse Test: Pulse Width  $\leq 100 \mu\text{s}$ , Duty Cycle  $\leq 2\%$ , Repetitive rating, pulse width limited by junction temperature  $T_{j(\text{MAX})} = 150^\circ\text{C}$ .

<sup>2)</sup> Device mounted on FR-4 substrate PC board, with minimum recommended pad layout.

<sup>3)</sup> Device mounted on FR-4 substrate PC board, 2oz copper, with 1-inch square copper plate.

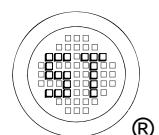

# MMFTP84K

Characteristics at  $T_a = 25^\circ\text{C}$  unless otherwise specified

Parameter	Symbol	Min.	Typ.	Max.	Unit
<b>STATIC PARAMETERS</b>					
Drain-Source Breakdown Voltage at $-I_D = 250 \mu\text{A}$	$-V_{(BR)DSS}$	60	-	-	V
Zero Gate Voltage Drain Current at $-V_{DS} = 25 \text{ V}$ at $-V_{DS} = 60 \text{ V}$	$-I_{DSS}$	-	-	0.1 1	$\mu\text{A}$
Gate-Source Leakage at $V_{GS} = \pm 20 \text{ V}$	$I_{GSS}$	-	-	$\pm 10$	$\mu\text{A}$
Gate-Source Threshold Voltage at $V_{DS} = V_{GS}$ , $-I_D = 250 \mu\text{A}$	$-V_{GS(th)}$	0.9	-	2	V
Drain-Source On-State Resistance at $-V_{GS} = 5 \text{ V}$ , $-I_D = 0.1 \text{ A}$	$R_{DS(on)}$	-	2.6	10	$\Omega$
<b>DYNAMIC PARAMETERS</b>					
Forward Transconductance at $-V_{DS} = 25 \text{ V}$ , $-I_D = 0.1 \text{ A}$ , $f = 1 \text{ KHz}$	$g_{fs}$	50	-	-	mS
Input Capacitance at $V_{GS} = 0 \text{ V}$ , $-V_{DS} = 30 \text{ V}$ , $f = 1 \text{ MHz}$	$C_{iss}$	-	38	-	pF
Output Capacitance at $V_{GS} = 0 \text{ V}$ , $-V_{DS} = 30 \text{ V}$ , $f = 1 \text{ MHz}$	$C_{oss}$	-	9	-	pF
Reverse Transfer Capacitance at $V_{GS} = 0 \text{ V}$ , $-V_{DS} = 30 \text{ V}$ , $f = 1 \text{ MHz}$	$C_{rss}$	-	6	-	pF
Total Gate Charge at $-V_{DS} = 25 \text{ V}$ , $-V_{GS} = 4.5 \text{ V}$ , $-I_D = 0.1 \text{ A}$	$Q_g$	-	1.1	-	nC
Gate Source Charge at $-V_{DS} = 25 \text{ V}$ , $-V_{GS} = 4.5 \text{ V}$ , $-I_D = 0.1 \text{ A}$	$Q_{gs}$	-	0.3	-	nC
Gate Drain Charge at $-V_{DS} = 25 \text{ V}$ , $-V_{GS} = 4.5 \text{ V}$ , $-I_D = 0.1 \text{ A}$	$Q_{gd}$	-	0.2	-	nC
Turn-On Rise Time at $-V_{DS} = 25 \text{ V}$ , $-V_{GS} = 10 \text{ V}$ , $-I_D = 0.1 \text{ A}$ , $R_g = 6.8 \Omega$	$t_{d(on)}$	-	14	-	ns
Turn-On Rise Time at $-V_{DS} = 25 \text{ V}$ , $-V_{GS} = 10 \text{ V}$ , $-I_D = 0.1 \text{ A}$ , $R_g = 6.8 \Omega$	$t_r$	-	4	-	ns
Turn-Off Delay Time at $-V_{DS} = 25 \text{ V}$ , $-V_{GS} = 10 \text{ V}$ , $-I_D = 0.1 \text{ A}$ , $R_g = 6.8 \Omega$	$t_{d(off)}$	-	15	-	ns
Turn-Off Fall Time at $-V_{DS} = 25 \text{ V}$ , $-V_{GS} = 10 \text{ V}$ , $-I_D = 0.1 \text{ A}$ , $R_g = 6.8 \Omega$	$t_f$	-	77	-	ns
<b>Body-Diode PARAMETERS</b>					
Drain-Source Diode Forward Voltage at $-I_S = 0.5 \text{ A}$	$-V_{SD}$	-	-	1.2	V
Body Diode Reverse Recovery Time at $-I_F = 0.1 \text{ A}$ , $di/dt = 100 \text{ A} / \mu\text{s}$	$t_{rr}$	-	60	-	ns
Body Diode Reverse Recovery Charge at $-I_F = 0.1 \text{ A}$ , $di/dt = 100 \text{ A} / \mu\text{s}$	$Q_{rr}$	-	58	-	nC

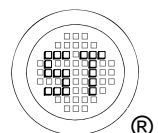

## Electrical Characteristics Curves

Fig. 1 Typical Output Characteristic

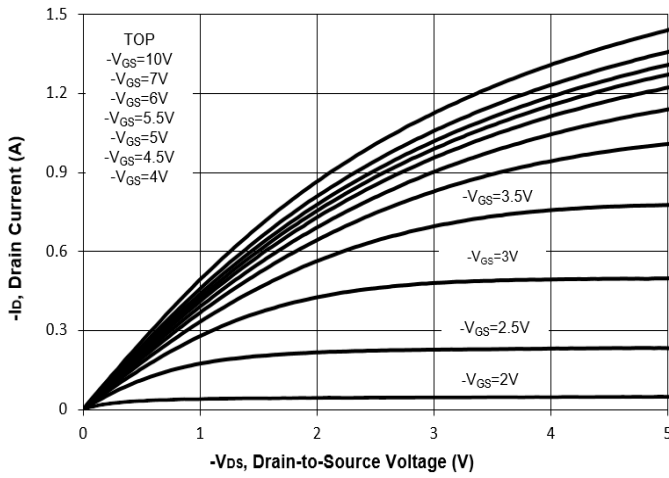

Fig. 2 Typical Transfer Characteristic

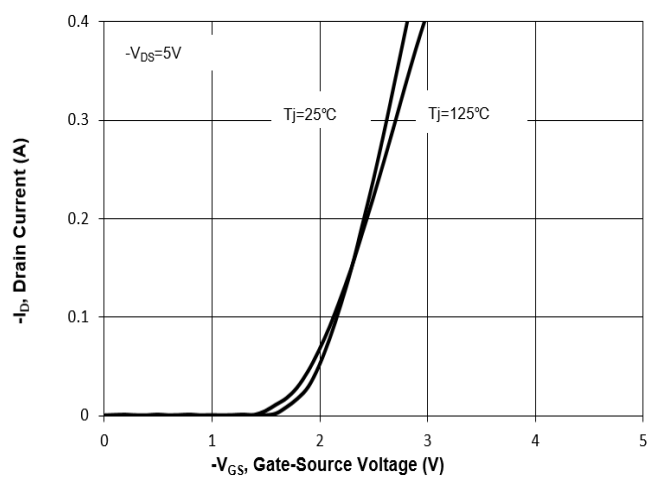

Fig. 3 on-Resistance vs. Gate Voltage

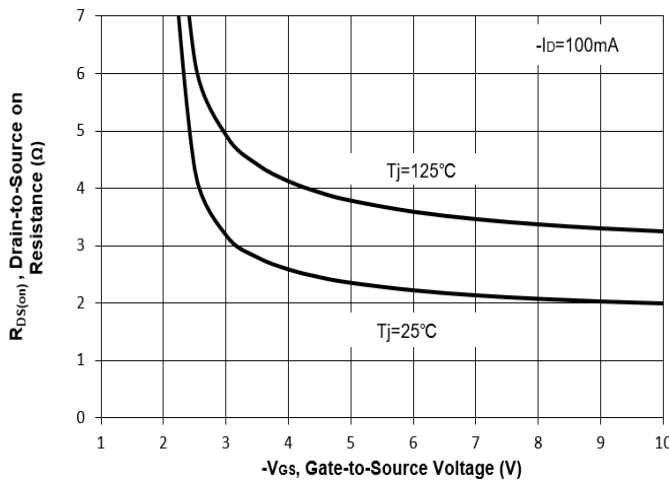

Fig. 4 on-Resistance vs. Tj

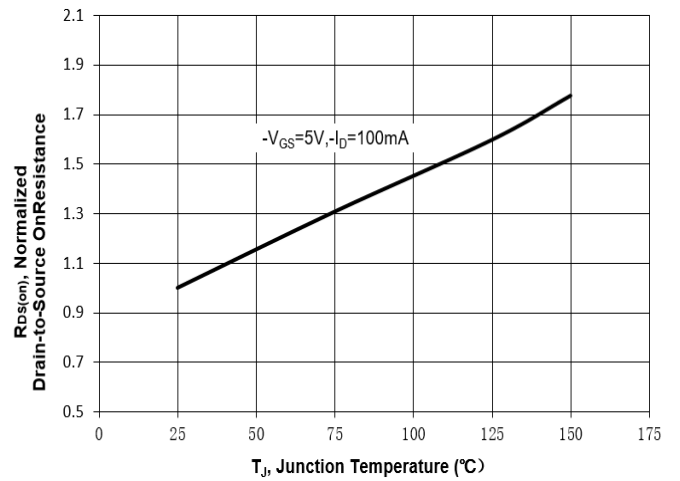

Fig. 5 On-Resistance vs. Drain Current

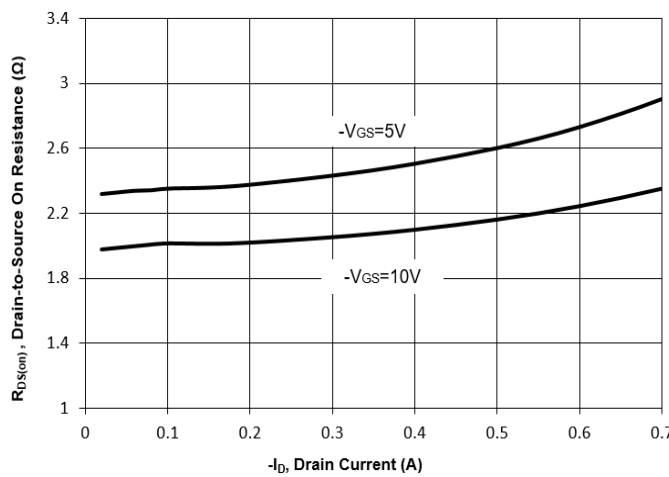
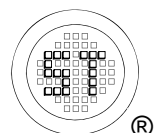
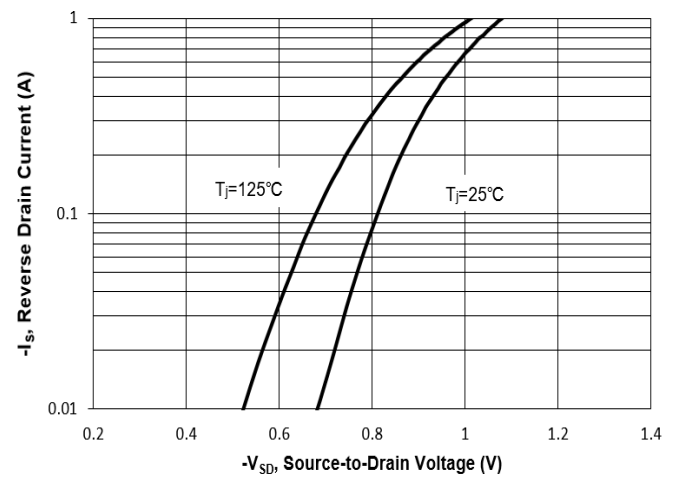

Fig. 6 Typical Forward Characteristic



## Electrical Characteristics Curves

Fig. 7  $V_{(BR)DSS}$  vs. Junction Temperature

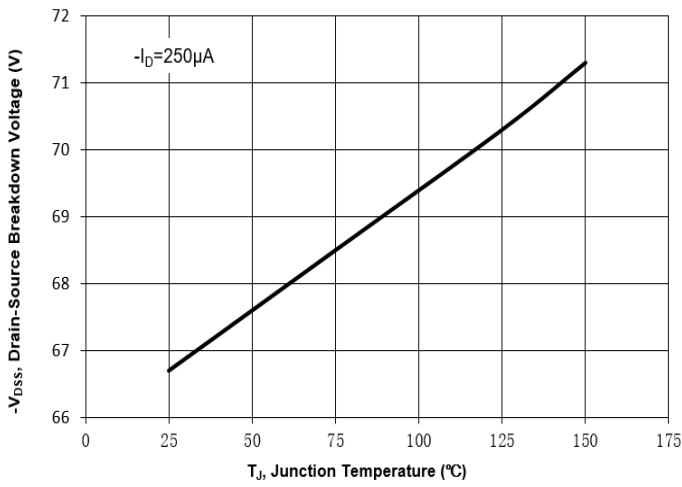

Fig. 8 Gate Threshold Variation vs.  $T_J$

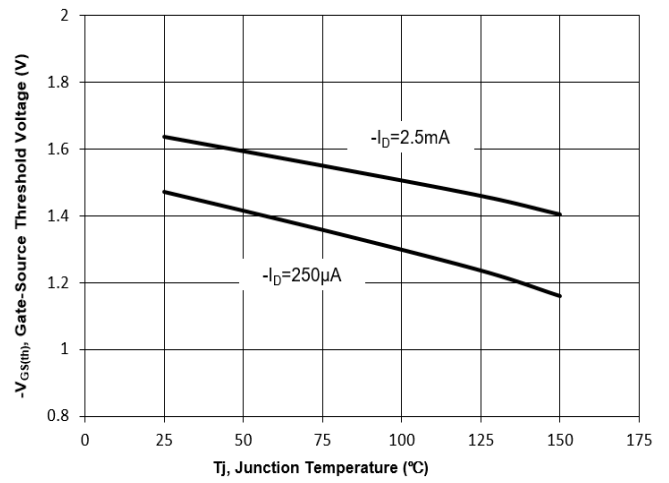

Fig. 9 Typical Junction Capacitance

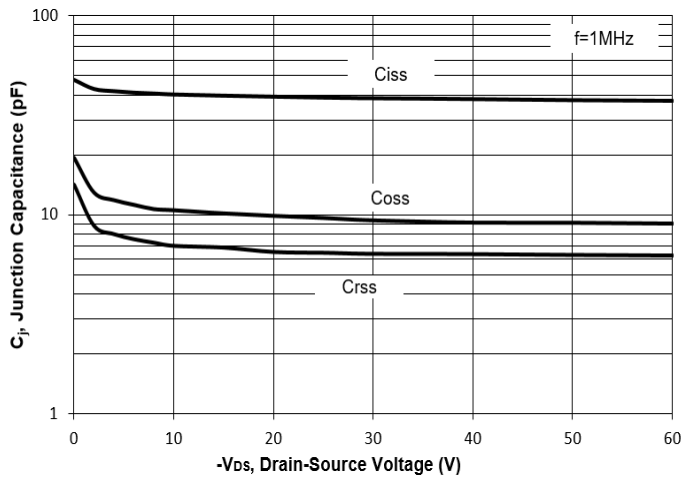

Fig. 10 Gate Charge

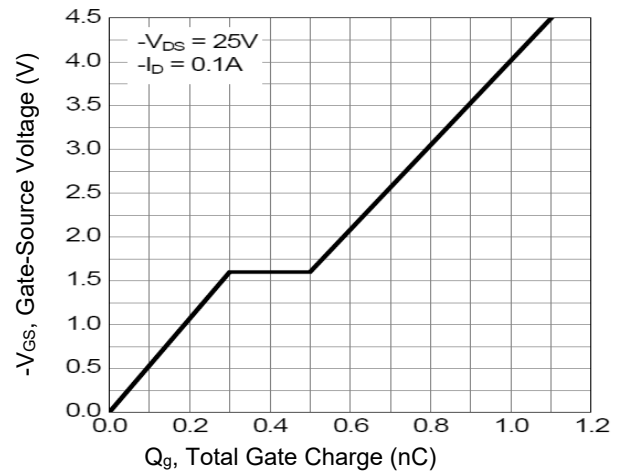
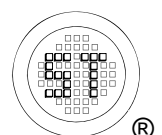
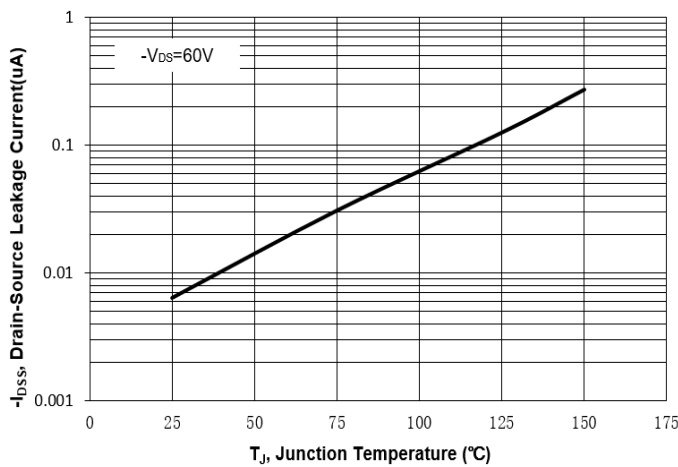

Fig. 11 Drain-Source Leakage Current vs.  $T_J$



# MMFTP84K

## Test Circuits

Fig.1-1 Switching times test circuit

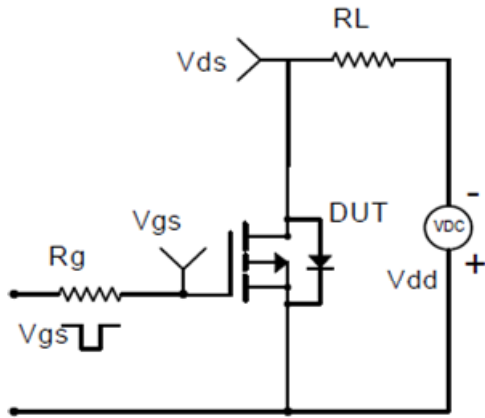

Fig.1-2 Switching Waveform

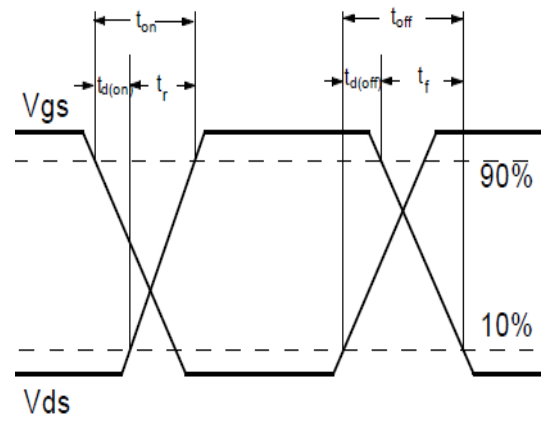

Fig.2-1 Gate charge test circuit

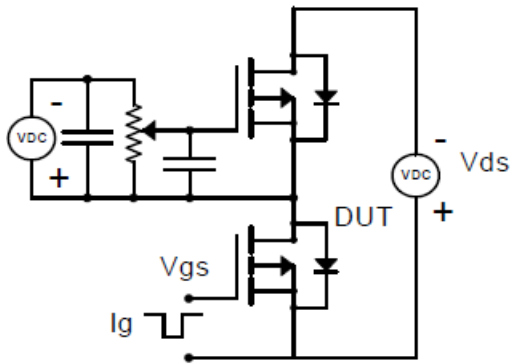
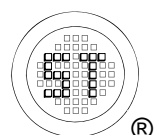
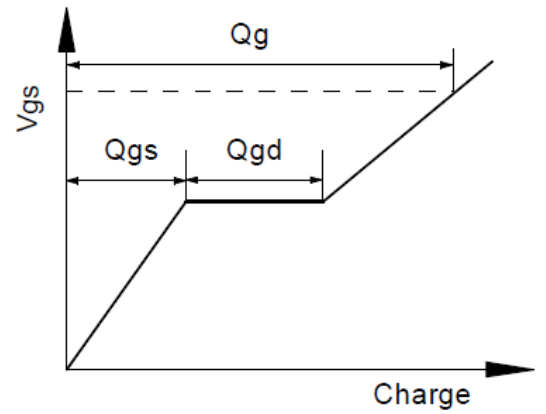

Fig.2-2 Gate charge waveform



# MMFTP84K

## PACKAGE OUTLINE

Plastic surface mounted package (Dimensions in mm)

SOT-23

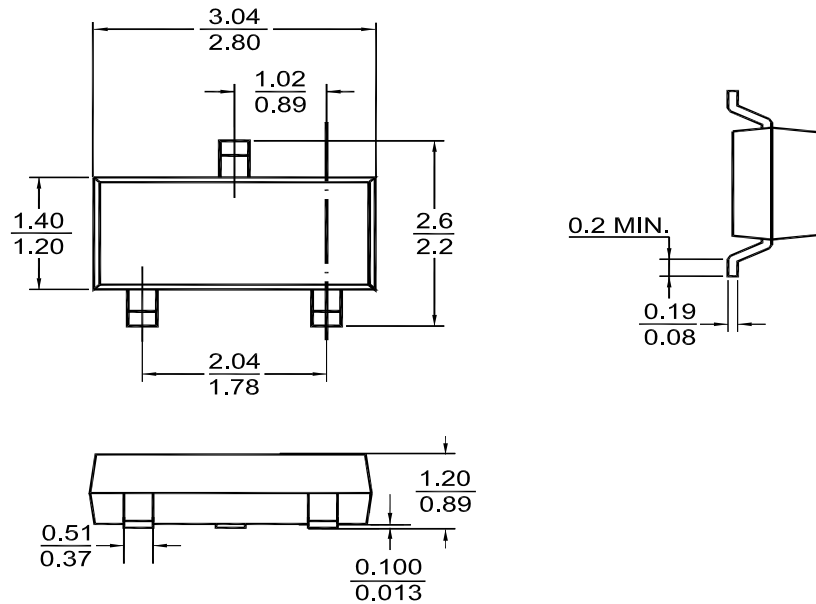

## Recommended Soldering Footprint

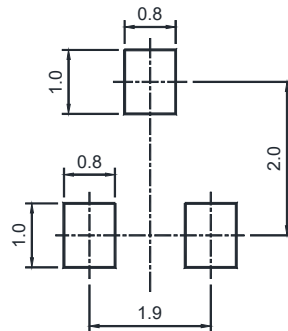

## Packing information

Package	Tape Width (mm)	Pitch		Reel Size		Per Reel Packing Quantity
		mm	inch	mm	inch	
SOT-23	8	4 ± 0.1	0.157 ± 0.004	178	7	3,000

## Marking information

" VY " = Part No.  
 "YM" = Date Code Marking  
 "Y" = Year  
 "M" = Month  
 Font type: Arial

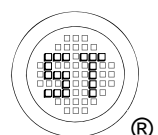
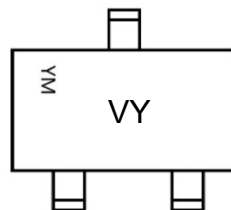

## X-ON Electronics

Largest Supplier of Electrical and Electronic Components

*Click to view similar products for [MOSFET](#) category:*

*Click to view products by [Semtech](#) manufacturer:*

Other Similar products are found below :

[IRFD120](#) [JANTX2N5237](#) [2SK2267\(Q\)](#) [BUK455-60A/B](#) [TK100A10N1,S4X\(S](#) [MIC4420CM-TR](#) [VN1206L](#) [NDP4060](#) [SI4482DY](#)  
[IRS2092STRPBF-EL](#) [IPS70R2K0CEAKMA1](#) [TK31J60W5,S1VQ\(O](#) [TK31J60W,S1VQ\(O](#) [TK16J60W,S1VQ\(O](#) [2SK2614\(TE16L1,Q\)](#)  
[DMN1017UCP3-7](#) [EFC2J004NUZTDG](#) [P85W28HP2F-7071](#) [DMN1053UCP4-7](#) [NTE2384](#) [DMC2700UDMQ-7](#) [DMN2080UCB4-7](#)  
[DMN61D9UWQ-13](#) [US6M2GTR](#) [DMN31D5UDJ-7](#) [DMP22D4UFO-7B](#) [IPS60R3K4CEAKMA1](#) [DMN1006UCA6-7](#) [DMN16M9UCA6-7](#)  
[STF5N65M6](#) [IRF40H233XTMA1](#) [STU5N65M6](#) [DMN6022SSD-13](#) [DMN13M9UCA6-7](#) [DMTH10H4M6SPS-13](#) [IPS60R360PFD7SAKMA1](#)  
[DMN2990UFB-7B](#) [SSM3K35CT,L3F](#) [IPLK60R1K0PFD7ATMA1](#) [2N7002W-G](#) [MCAC30N06Y-TP](#) [IPWS65R035CFD7AXKSA1](#)  
[MCQ7328-TP](#) [SSM3J143TU,LXHF](#) [DMN12M3UCA6-7](#) [PJMF280N65E1\\_T0\\_00201](#) [PJMF380N65E1\\_T0\\_00201](#)  
[PJMF280N60E1\\_T0\\_00201](#) [PJMF600N65E1\\_T0\\_00201](#) [PJMF900N65E1\\_T0\\_00201](#)