

PROTECTION PRODUCTS

Description

RClamp®0542ZA is an ultra low capacitance ESD protection device designed to protect two high-speed lines in an 0201 footprint. This revolutionary package design reduces board space requirements by more than 50% over existing single line solutions. RClamp0542ZA is a three pin device with identical low capacitance TVS diodes connected to each pin. Any two pins may be connected to high-speed lines, while the third pin is connected to ground. This gives the designer maximum flexibility in pcb routing. Each line has a maximum capacitance of only 0.30pF resulting in a typical corner frequency of 12GHz.

RClamp0542ZA is in a 3-pin SLP0603P3X3F package. It measures 0.62 x 0.32 mm with a nominal height of only 0.25mm. Leads are finished with lead-free NiAu. The combination of small size and high ESD surge capability makes them ideal for use in portable applications such as cellular phones, digital cameras, and tablets.

Features

- High ESD withstand voltage
 - ♦ IEC 61000-4-2 (ESD) 17kV (air), 12kV (contact)
- Very small PCB area
- Protects two high-speed data lines
- Working voltage: 5V
- Low reverse leakage current: <1nA typ at VR=5V
- Low capacitance: 0.30pF maximum
- Dynamic resistance: 1.17 Ohms (Typ)
- Solid-state silicon-avalanche technology

Mechanical Characteristics

- SLP0603P3X3F package
- Pb-Free, Halogen Free, RoHS/WEEE Compliant
- Nominal Dimensions: 0.62 x 0.32 x 0.25 mm
- Lead Finish: NiAu
- Marking : Marking code
- Packaging : Tape and Reel

Applications

- High-Speed Lines
- MIPI / MDDI
- USB 3.0
- HDMI
- MHL
- eDP

Nominal Dimensions

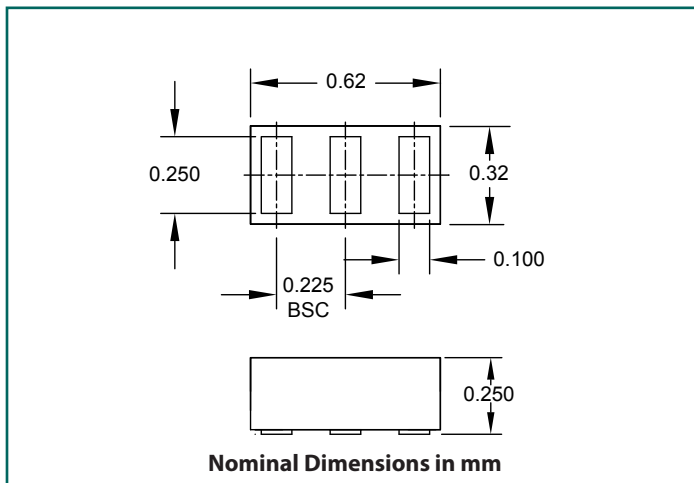

Functional Schematic

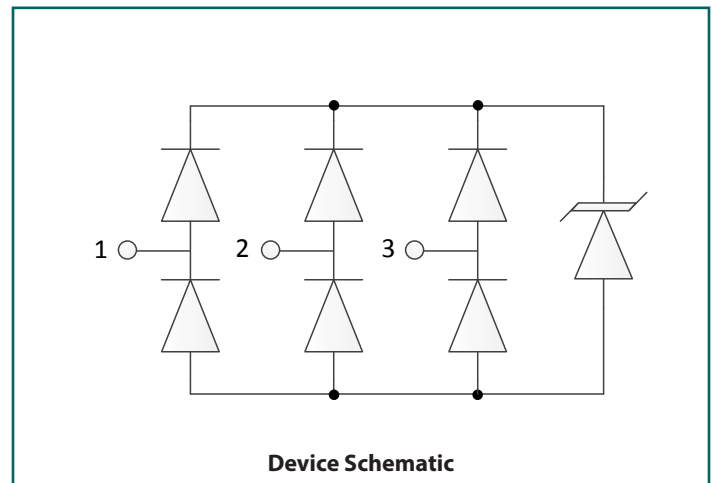

Absolute Maximum Ratings

Rating	Symbol	Value	Units
Peak Pulse Power (tp = 8/20μs)	P _{PK}	40	W
Peak Pulse Current (tp = 8/20μs)	I _{PP}	2	A
ESD per IEC 61000-4-2 (Air) ⁽¹⁾ ESD per IEC 61000-4-2 (Contact) ⁽¹⁾	V _{ESD}	±17 ±12	kV
Operating Temperature	T _J	-40 to +85	°C
Storage Temperature	T _{STG}	-55 to +150	°C

Electrical Characteristics (T=25°C unless otherwise specified)

Parameter	Symbol	Conditions	Min.	Typ.	Max.	Units	
Reverse Stand-Off Voltage	V _{RWM}	-40°C to 85°C Between any two pins			5	V	
Reverse Breakdown Voltage	V _{BR}	I _t = 10mA, Between any two pins	-40°C to 85°C	6.5	9.5	11.5	V
Reverse Leakage Current	I _R	V _{RWM} = 5V	T = 25°C		0.01	0.050	μA
			T = 85°C		0.05	0.250	μA
Clamping Voltage	V _C	I _{pp} = 2A, tp = 8/20μs, Between any two pins		12	20	V	
ESD Clamping Voltage ²	V _C	I _{pp} = 4A, tp = 0.2/100ns (TLP) Pin 1 to 2, Pin 3 to 2		16		V	
ESD Clamping Voltage ²	V _C	I _{pp} = 16A, tp = 0.2/100ns (TLP) Pin 1 to 2, Pin 3 to 2		30		V	
Dynamic Resistance ^{2,3}	R _{DYN}	tp = 0.2/100ns (TLP) Pin 1 to 2, Pin 3 to 2		1.17		Ohms	
Cut-Off Frequency	f _C	Insertion Loss (S21) = -3dB		12		GHz	
Junction Capacitance	C _J	V _R = 0V, f = 1MHz Between any two pins	T = 25°C	0.27	0.30	pF	
Change in Capacitance over VR	ΔC _{JVR}	VR = 0 - 5V, f = 1MHz			0.030	pF	

Notes:

(1): ESD Gun return path to Ground Reference Plane (GRP)

(2): Transmission Line Pulse Test (TLP) Settings: tp = 100ns, tr = 0.2ns, I_{TLP} and V_{TLP} averaging window: t₁ = 70ns to t₂ = 90ns.

(3): Dynamic resistance calculated from I_{TLP} = 4A to I_{TLP} = 16A

Typical Characteristics

ESD Clamping (+8kV Contact per IEC 61000-4-2)

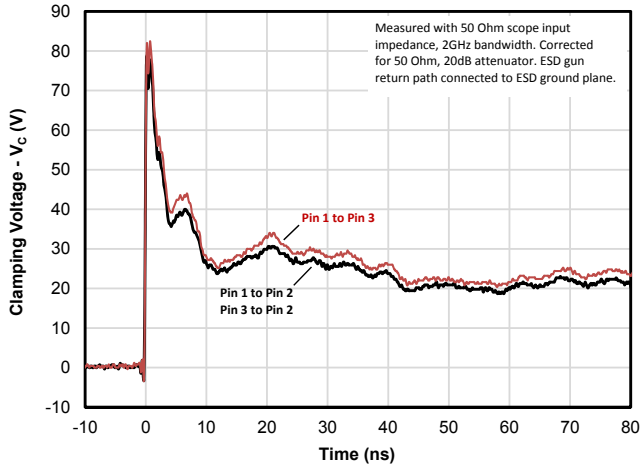

ESD Clamping (-8kV Contact per IEC 61000-4-2)

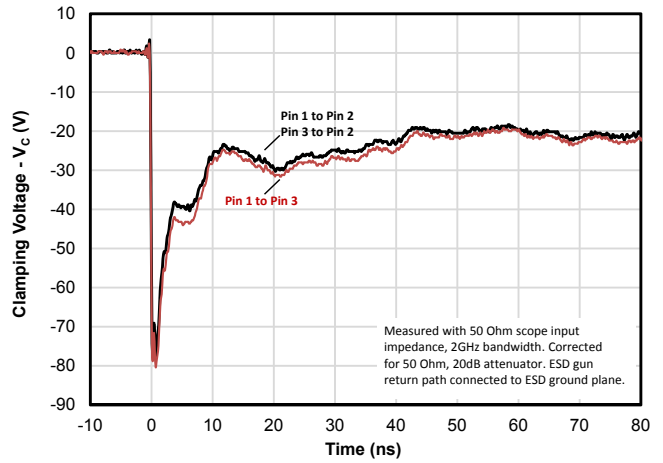

TLP IV Curve (Positive Pulse)

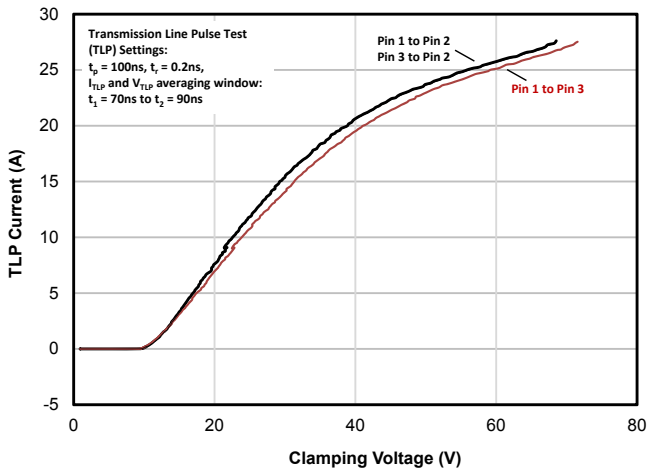

TLP IV Curve (Negative Pulse)

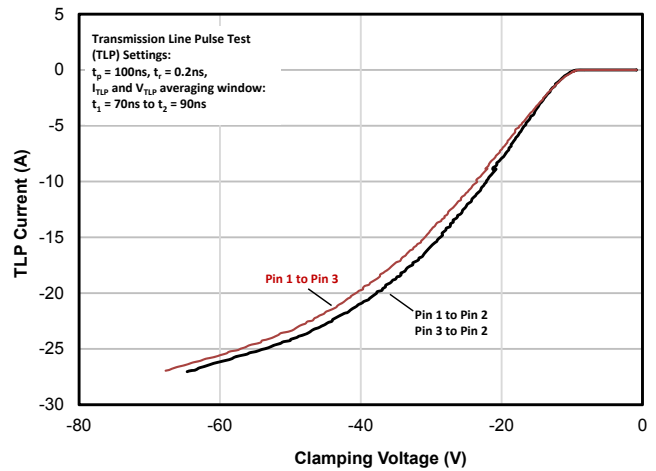

Capacitance vs. Reverse Voltage

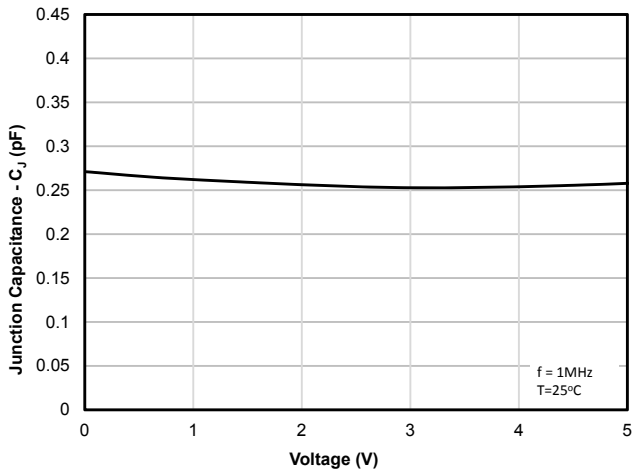

Capacitance vs. Temperature

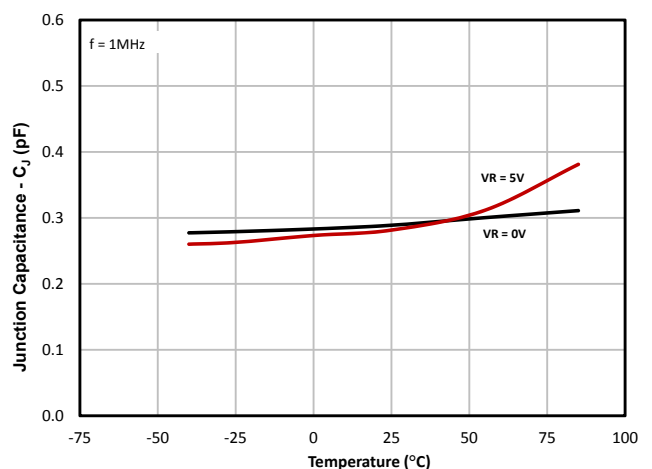

Typical Characteristics (Continued)

Insertion Loss - S21

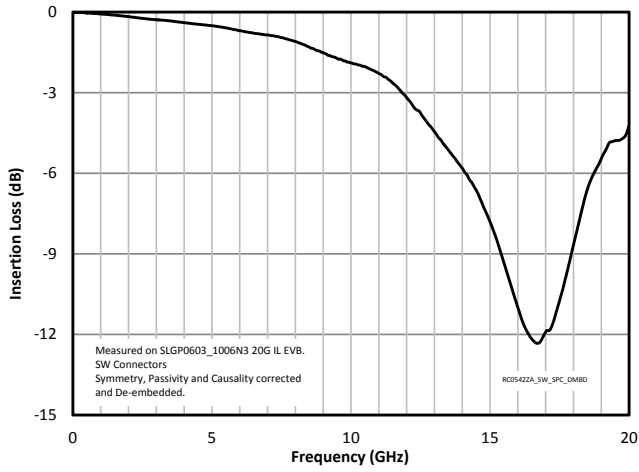

Clamping Voltage vs. Peak Pulse Current ($t_p=8/20\mu s$)

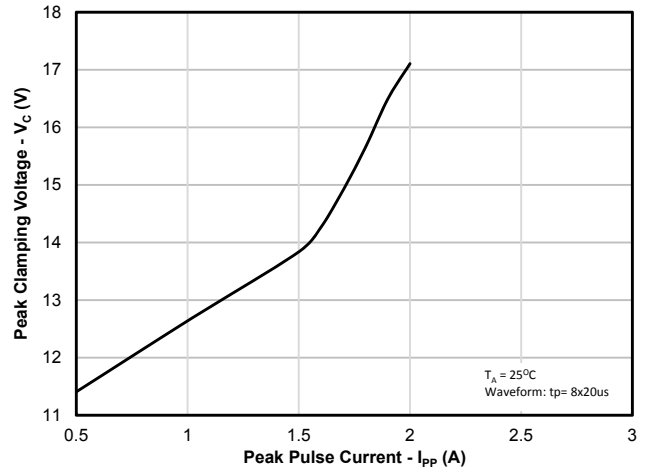

Analog Crosstalk

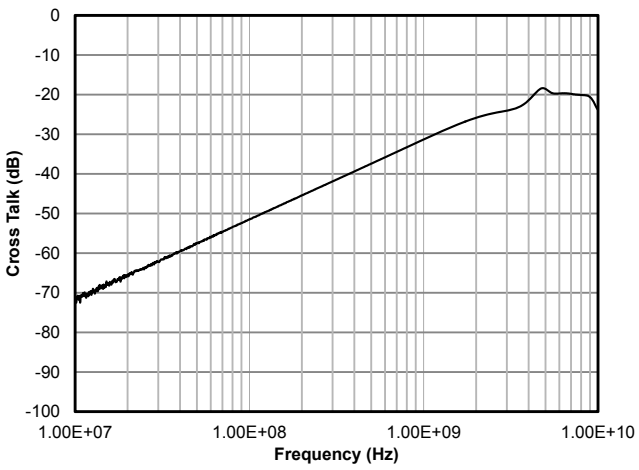

Applications Information

Assembly Guidelines

The small size of this device means that some care must be taken during the mounting process to insure reliable solder joint. The figure at the right details Semtech's recommended mounting pattern. Recommended assembly guidelines are shown in Table 1. Note that these are only recommendations and should serve only as a starting point for design since there are many factors that affect the assembly process. Exact manufacturing parameters will require some experimentation to get the desired solder application. Semtech's recommended mounting pattern is based on the following design guidelines:

Land Pattern

The recommended land pattern follows IPC standards and is designed for maximum solder coverage. Detailed dimensions are shown elsewhere in this document.

Solder Stencil

Stencil design is one of the key factors which will determine the volume of solder paste which is deposited onto the land pad. The area ratio of the stencil aperture will determine how well the stencil will print. The area ratio takes into account the aperture shape, aperture size, and stencil thickness. An area ratio of 0.70 – 0.75 is preferred for the subject package. The area ratio of a rectangular aperture is given as:

$$\text{Area Ratio} = (L * W) / (2 * (L + W) * T)$$

Where:

L = Aperture Length

W = Aperture Width

T = Stencil Thickness

Semtech recommends a stencil thickness of 0.100mm for this device. The stencil should be laser cut with electro-polished finish. The stencil should have a positive taper of approximately 5 degrees. Electro polishing and tapering the walls results in reduced surface friction and better paste release. For small pitch components, Semtech recommends a square aperture with rounded corners for consistent solder release. Due to the small aperture size, a solder paste with Type 4 or smaller particles are recommended.

Recommended Mounting Pattern

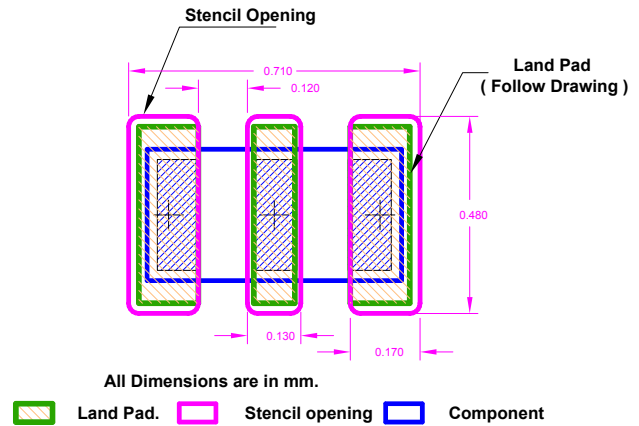

Assembly Parameter	Recommendation
Solder Stencil Design	Laser Cut, Electro-Polished
Aperture Shape	Rectangular with rounded corners
Solder Stencil Thickness	0.100mm (0.004")
Solder Paste Type	Type 4 size sphere or smaller
Solder Reflow Profile	Per JEDEC J-STD-020
PCB Solder pad Design	Non-Solder Mask Defined
PCB Pad Finish	OSP or NiAu

Outline Drawing - SLP0603P3X3F

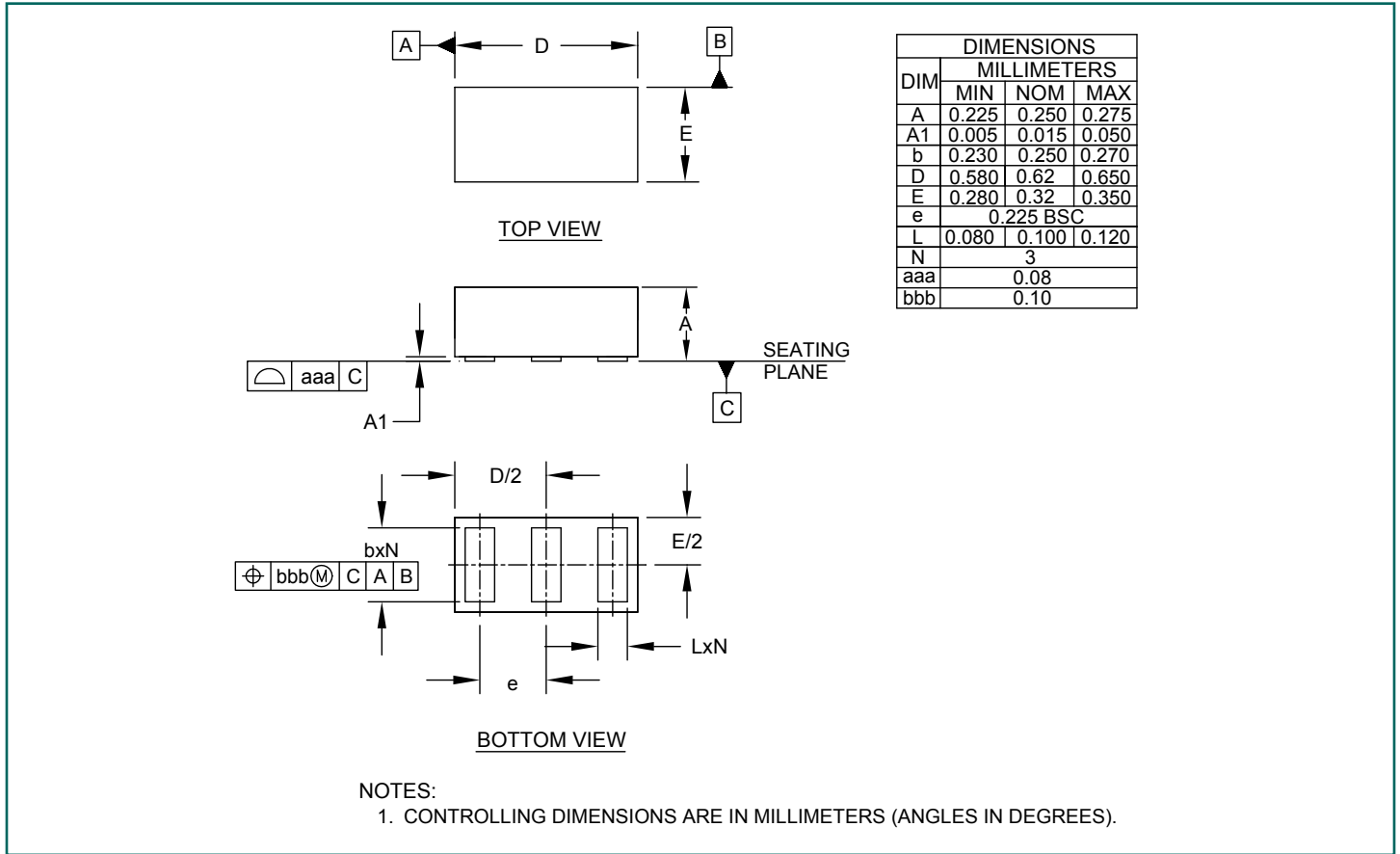

Land Pattern - SLP0603P3X3F

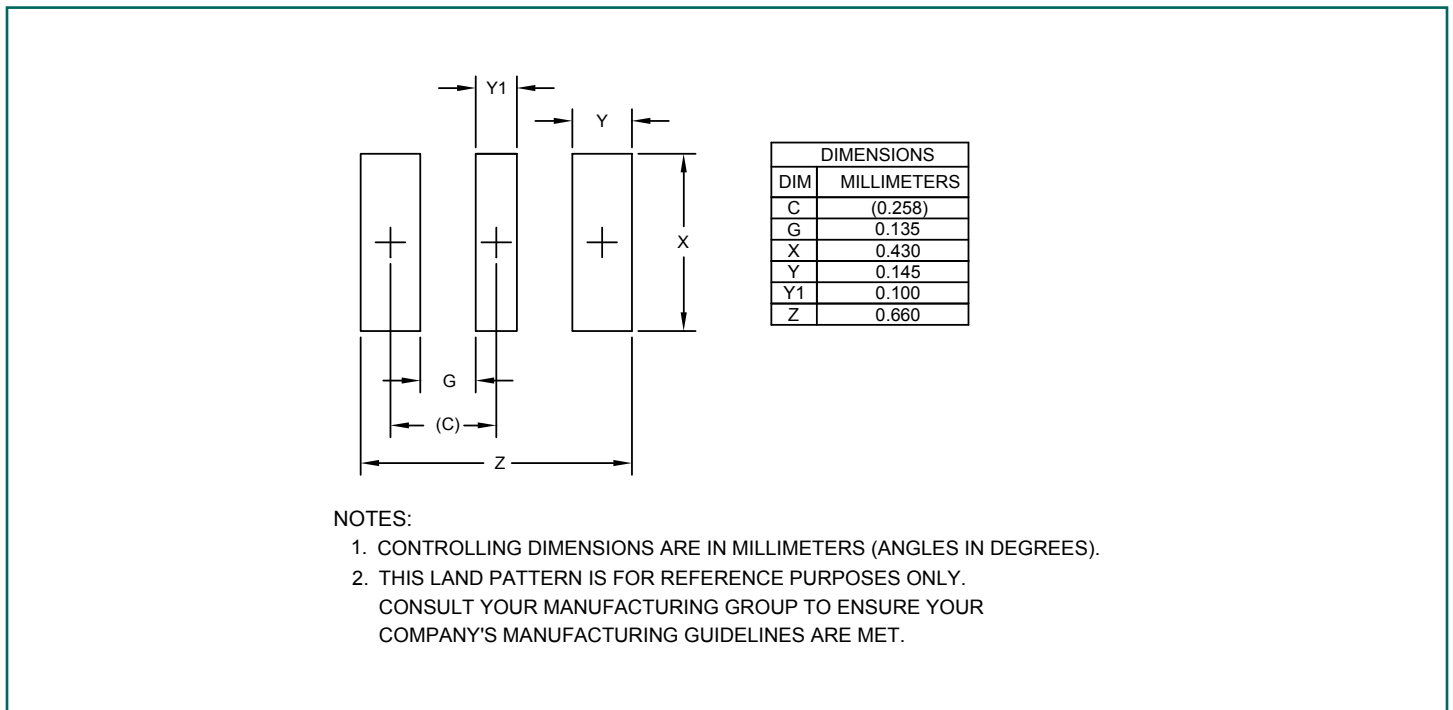

Marking Code

7F

Notes: Device is electrically symmetrical

Tape and Reel Specification

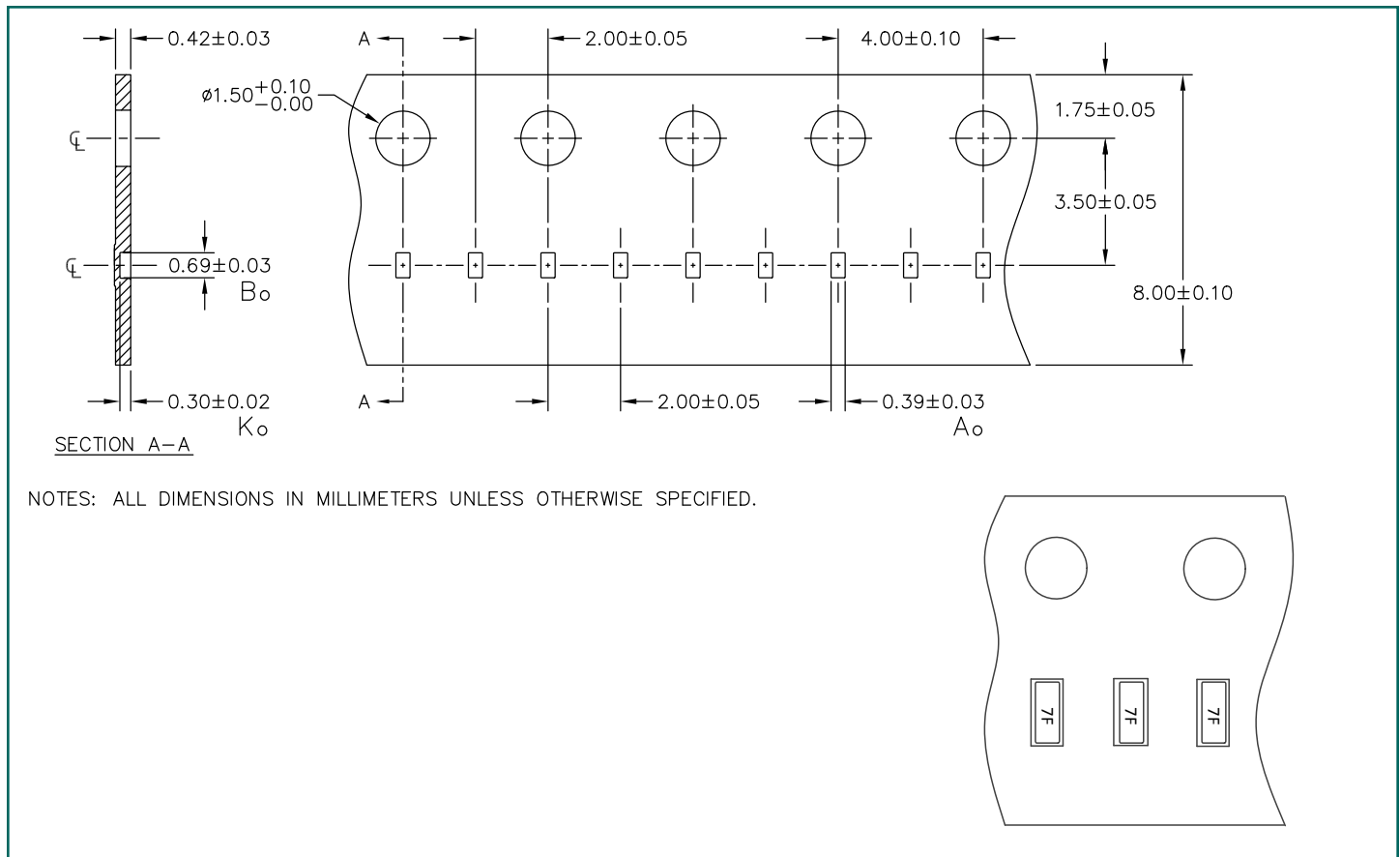

Ordering Information

Part Number	Qty per Reel	Reel Size
RClamp0542ZATFT	15000	7 Inch
RailClamp and RClamp are registered trademarks of Semtech Corporation.		



IMPORTANT NOTICE

Information relating to this product and the application or design described herein is believed to be reliable, however such information is provided as a guide only and Semtech assumes no liability for any errors in this document, or for the application or design described herein. Semtech reserves the right to make changes to the product or this document at any time without notice. Buyers should obtain the latest relevant information before placing orders and should verify that such information is current and complete. Semtech warrants performance of its products to the specifications applicable at the time of sale, and all sales are made in accordance with Semtech's standard terms and conditions of sale.

SEMTECH PRODUCTS ARE NOT DESIGNED, INTENDED, AUTHORIZED OR WARRANTED TO BE SUITABLE FOR USE IN LIFE-SUPPORT APPLICATIONS, DEVICES OR SYSTEMS, OR IN NUCLEAR APPLICATIONS IN WHICH THE FAILURE COULD BE REASONABLY EXPECTED TO RESULT IN PERSONAL INJURY, LOSS OF LIFE OR SEVERE PROPERTY OR ENVIRONMENTAL DAMAGE. INCLUSION OF SEMTECH PRODUCTS IN SUCH APPLICATIONS IS UNDERSTOOD TO BE UNDERTAKEN SOLELY AT THE CUSTOMER'S OWN RISK. Should a customer purchase or use Semtech products for any such unauthorized application, the customer shall indemnify and hold Semtech and its officers, employees, subsidiaries, affiliates, and distributors harmless against all claims, costs damages and attorney fees which could arise.

The Semtech name and logo are registered trademarks of the Semtech Corporation. All other trademarks and trade names mentioned may be marks and names of Semtech or their respective companies. Semtech reserves the right to make changes to, or discontinue any products described in this document without further notice. Semtech makes no warranty, representation or guarantee, express or implied, regarding the suitability of its products for any particular purpose. All rights reserved.

© Semtech 2015

Contact Information

Semtech Corporation
200 Flynn Road, Camarillo, CA 93012
Phone: (805) 498-2111, Fax: (805) 498-3804
www.semtech.com

X-ON Electronics

Largest Supplier of Electrical and Electronic Components

Click to view similar products for [ESD Suppressors / TVS Diodes](#) category:

Click to view products by [Semtech](#) manufacturer:

Other Similar products are found below :

[60KS200C](#) [D12V0H1U2WS-7](#) [D18V0L1B2LP-7B](#) [82356050220](#) [D5V0M5U6V-7](#) [NTE4902](#) [P4KE27CA](#) [P6KE11CA](#) [P6KE39CA-TP](#)
[P6KE8.2A](#) [SA110CA](#) [SA60CA](#) [SA64CA](#) [SMBJ12CATR](#) [SMBJ8.0A](#) [SMLJ30CA-TP](#) [ESD101-B1-02ELS E6327](#) [ESD112-B1-02EL E6327](#)
[ESD119B1W01005E6327XTSA1](#) [ESD5V0L1B02VH6327XTSA1](#) [ESD7451N2T5G](#) [19180-510](#) [CPDT-5V0USP-HF](#) [3.0SMCJ33CA-F](#)
[3.0SMCJ36A-F](#) [HSPC16701B02TP](#) [D3V3Q1B2DLP3-7](#) [D55V0M1B2WS-7](#) [DESD5V0U1BL-7B](#) [DRTR5V0U4SL-7](#) [SCM1293A-04SO](#)
[ESD200-B1-CSP0201 E6327](#) [ESD203-B1-02EL E6327](#) [SM12-7](#) [SMF8.0A-TP](#) [SMLJ45CA-TP](#) [CEN955 W/DATA](#) [82350120560](#)
[82356240030](#) [VESD12A1A-HD1-GS08](#) [CPDUR5V0R-HF](#) [CPDUR24V-HF](#) [CPDQC5V0U-HF](#) [CPDQC5V0USP-HF](#) [CPDQC5V0-HF](#)
[D1213A-01LP4-7B](#) [D1213A-02WL-7](#) [ESDLIN1524BJ-HQ](#) [5KP100A](#) [5KP15A](#)