

PROTECTION PRODUCTS

Description

RClamp®0561PQ is an ultra low capacitance ESD protection device specifically designed to protect high-speed differential lines. It offers desirable characteristics for board level protection including fast response time, low operating and clamping voltage, and no device degradation.

RClamp0561PQ features extremely good ESD protection characteristics highlighted by low peak ESD clamping voltage, and high ESD withstand voltage (+/-15kV contact per IEC 61000-4-2). RClamp0561PQ has a typical capacitance of 0.14pF allowing it to be used in high bandwidth applications such as HDMI 2.0 4K/2K, Thunderbolt, and USB 3.1. Each device will protect one high-speed data line operating up to 5.5 volts.

RClamp0561PQ is in a 2-pin SLP1006P2 package measuring 1.0 x 0.6 mm with a nominal height of 0.50mm. Leads are finished with NiPdAu. The small package gives the designer the flexibility to protect single lines in applications where arrays are not practical.

Nominal Dimensions

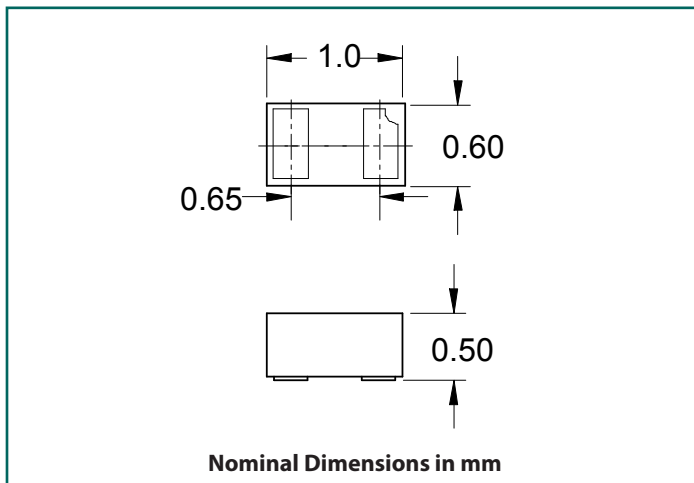

Features

- High ESD withstand voltage
 - ♦ IEC 61000-4-2 (ESD) 18kV (air), 15kV (contact)
- Low capacitance: 0.14pF Typical
- Qualified to AEC-Q100
- Very small PCB area
- Protects one high-speed line
- Working voltage: 5.5V
- Typical dynamic resistance: 1.2Ω
- Large operating bandwidth: 16GHz
- Solid-state silicon-avalanche technology

Mechanical Characteristics

- SLP1006P2 Package
- Pb-Free, Halogen Free, RoHS/WEEE Compliant
- Nominal Dimensions: 1.0 x 0.60 x 0.50 mm
- Lead Finish: NiPdAu
- Marking : Marking Code
- Packaging : Tape and Reel

Applications

- HDMI 1.4 and HDMI 2.0
- USB 3.0 and USB 3.1
- Automotive infotainment
- USB Type-C

Schematic and Pin Configuration

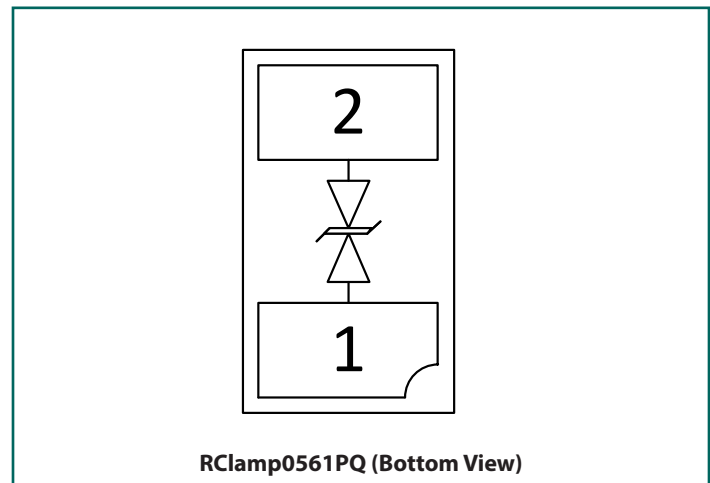

Absolute Maximum Ratings

Rating	Symbol	Value	Units
Peak Pulse Power ($t_p = 8/20\mu\text{s}$)	P_{PK}	40	W
Peak Pulse Current ($t_p = 8/20\mu\text{s}$)	I_{PP}	2	A
ESD per IEC 61000-4-2 (Air) ⁽¹⁾ ESD per IEC 61000-4-2 (Contact) ⁽¹⁾	V_{ESD}	± 18 ± 15	kV
Operating Temperature	T_J	-40 to +125	°C
Storage Temperature	T_{STG}	-55 to +150	°C

Electrical Characteristics (T=25°C unless otherwise specified)

Parameter	Symbol	Conditions	Min.	Typ.	Max.	Units	
Reverse Stand-Off Voltage	V_{RWM}	-40°C to 125°C			5.5	V	
Reverse Breakdown Voltage	V_{BR}	$I_t = 1\text{mA}$	-40°C to 125°C	6.5	9	10.5	V
Reverse Leakage Current	I_R	$V_{RWM} = 5.5\text{V}$	T = 25°C		<10	50	nA
			T = 125°C		<10	150	nA
Clamping Voltage	V_C	$I_{PP} = 2\text{A}$, $t_p = 8/20\mu\text{s}$		15.5	20	V	
ESD Clamping Voltage ²	V_C	$I_{PP} = 4\text{A}$, $t_p = 0.2/100\text{ns}$ (TLP)		14.5		V	
ESD Clamping Voltage ²	V_C	$I_{PP} = 16\text{A}$, $t_p = 0.2/100\text{ns}$ (TLP)		29		V	
Dynamic Resistance ^{2,3}	R_{DYN}	$t_p = 0.2/100\text{ns}$ (TLP)		1.2		Ohms	
Junction Capacitance	C_J	$V_R = 0\text{V}$, $f = 1\text{MHz}$	T = 25°C		0.14	0.18	pF
Cutoff Frequency	F_C	-3dB			16		GHz

Notes:

- (1): ESD gun return path connected to Ground Reference Plane (GRP)
- (2): Transmission Line Pulse Test (TLP) Settings: $t_p = 100\text{ns}$, $t_r = 0.2\text{ns}$, I_{TLP} and V_{TLP} averaging window: $t_1 = 70\text{ns}$ to $t_2 = 90\text{ns}$
- (3): Dynamic resistance calculated from $I_{TLP} = 4\text{A}$ to $I_{TLP} = 16\text{A}$

Typical Characteristics

ESD Clamping (+8kV Contact per IEC 61000-4-2)

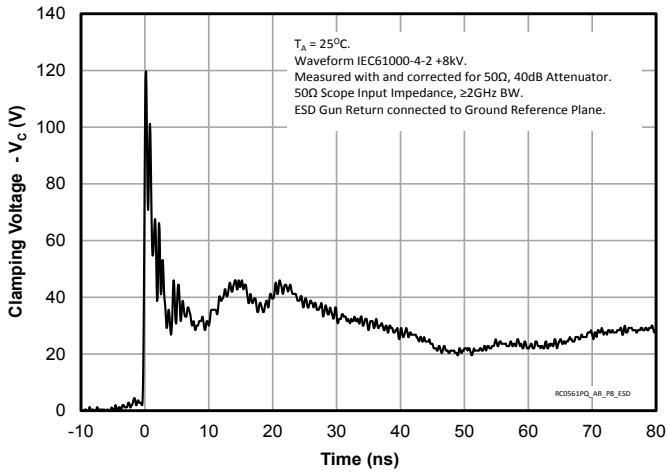

ESD Clamping (-8kV Contact per IEC 61000-4-2)

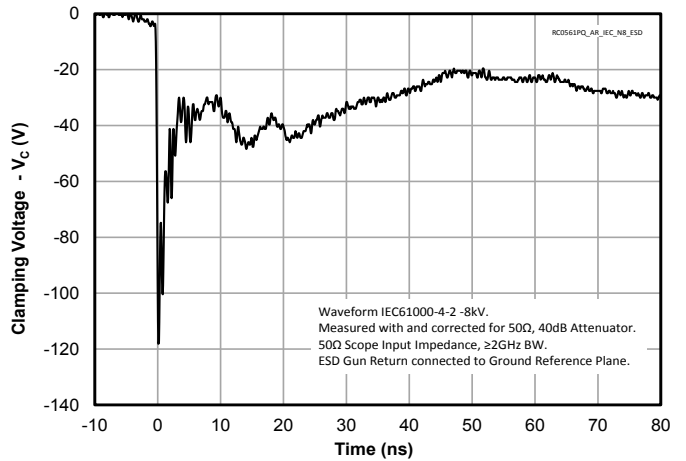

ESD Clamping (+8kV Contact per ISO-10605 150pF, 330 Ω)

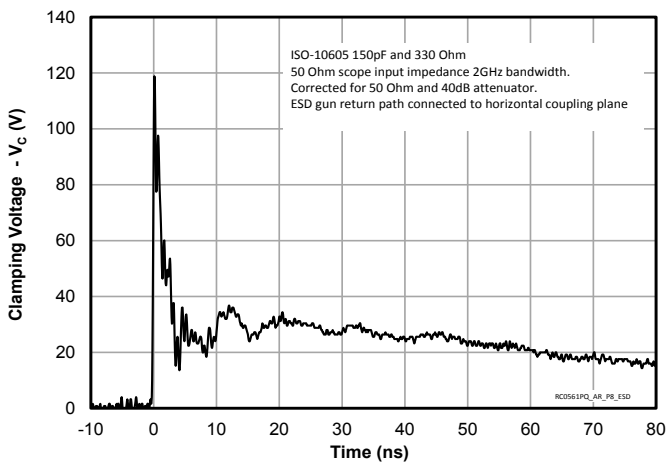

ESD Clamping (-8kV Contact per ISO-10605 150pF, 330 Ω)

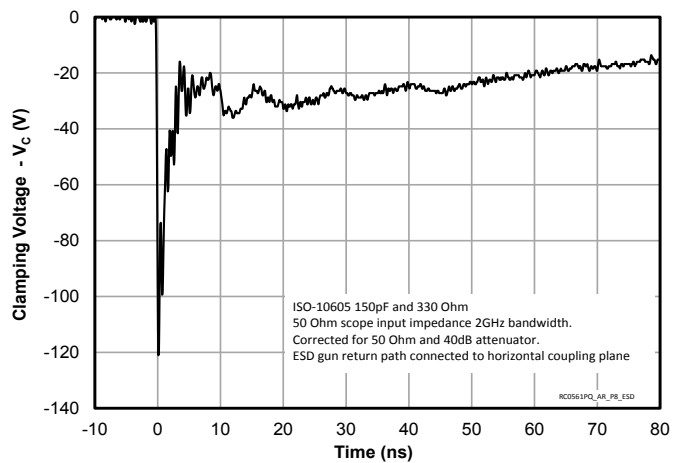

ESD Clamping (+8kV Contact per ISO-10605 330pF, 330 Ω)

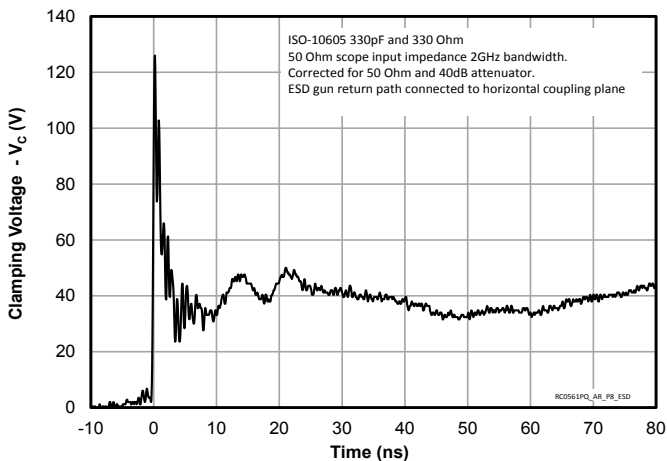

ESD Clamping (-8kV Contact per ISO-10605 330pF, 330 Ω)

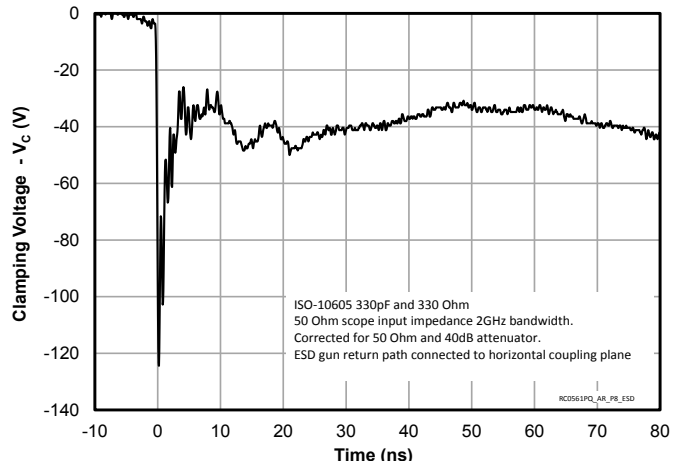

Typical Characteristics (Continued)

ESD Clamping (+8kV Contact per ISO-10605 330pF, 2kΩ)

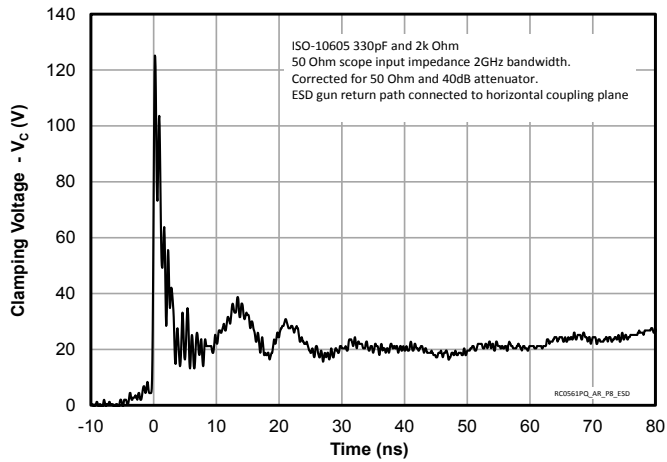

ESD Clamping (-8kV Contact per ISO-10605 330pF, 2kΩ)

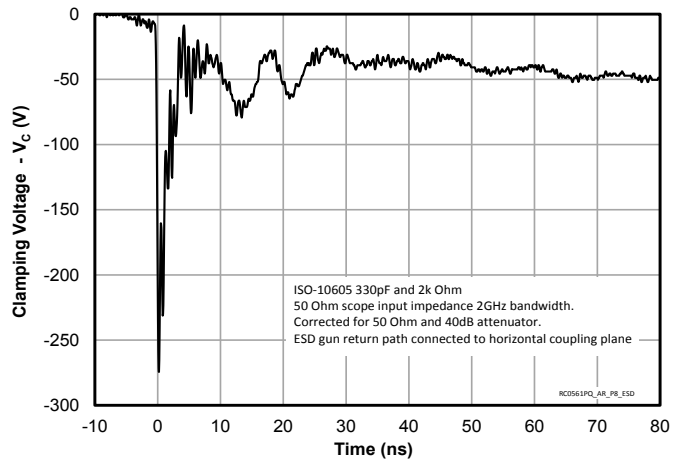

TLP Characteristic (Positive Pulse)

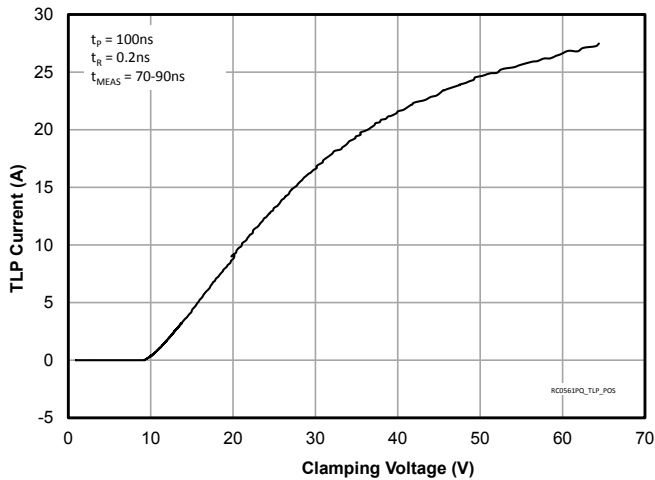

TLP Characteristic (Negative Pulse)

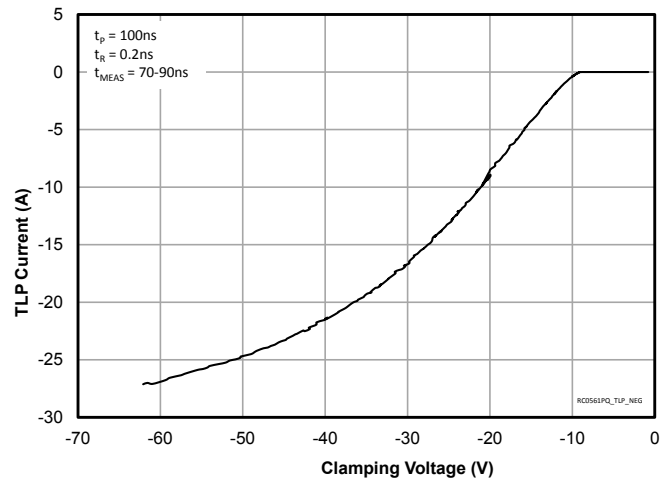

Capacitance vs. Reverse Voltage

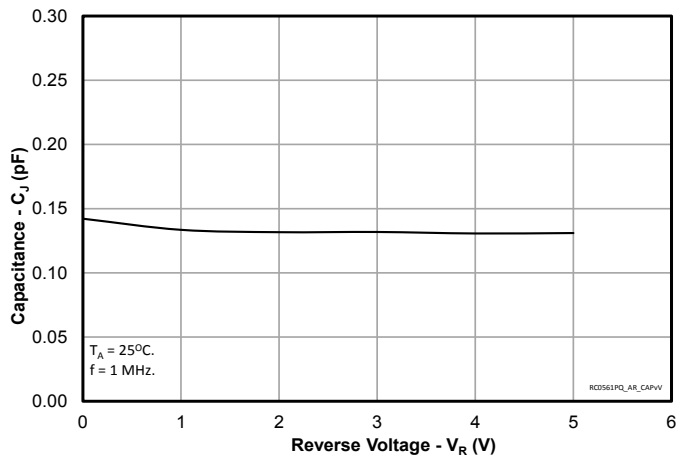

Insertion Loss (S21)

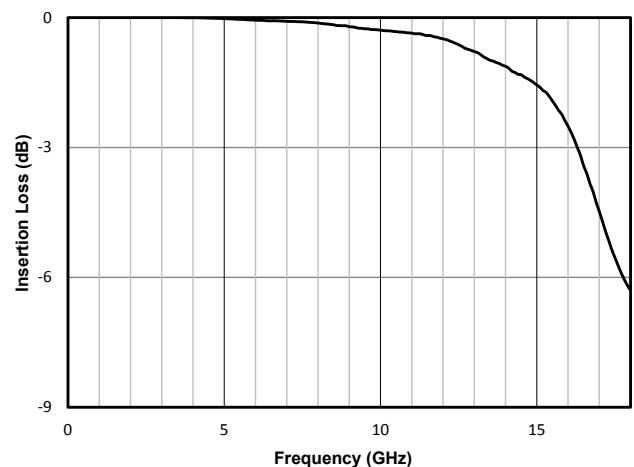

Typical Characteristics (Continued)

5Gb/s (USB 3.1 Gen 1) Eye Diagram with RClamp0561PQ

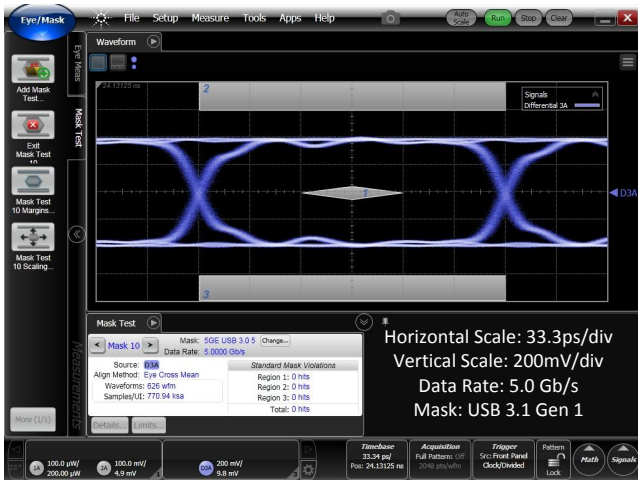

5Gb/s (USB 3.1 Gen 1) Eye Diagram without RClamp0561PQ

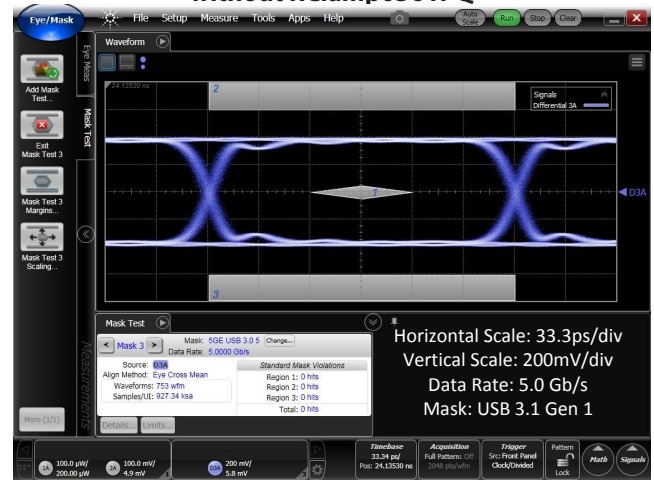

10Gb/s (USB 3.1 Gen 2) Eye Diagram with RClamp0561PQ

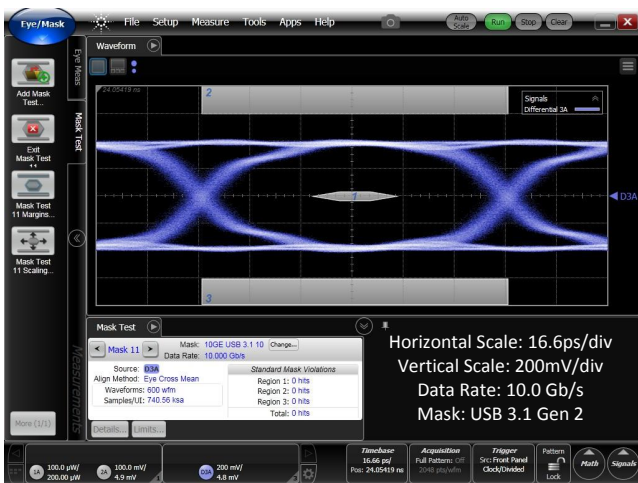

10Gb/s (USB 3.1 Gen 2) Eye Diagram without RClamp0561PQ

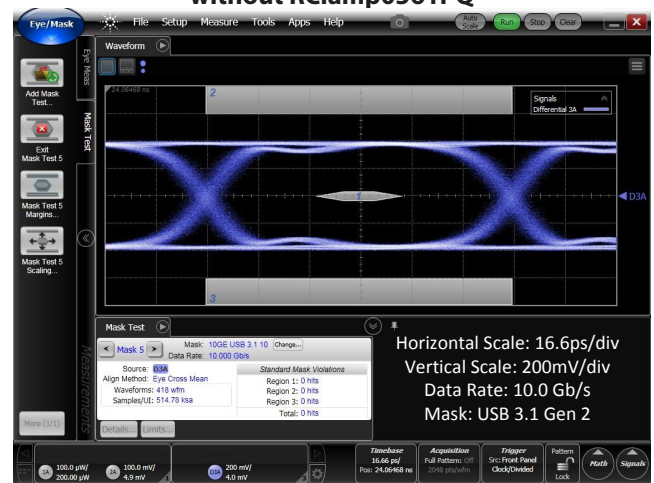

5.94Gb/s (HDMI 2.0) Eye Diagram with RClamp0561PQ

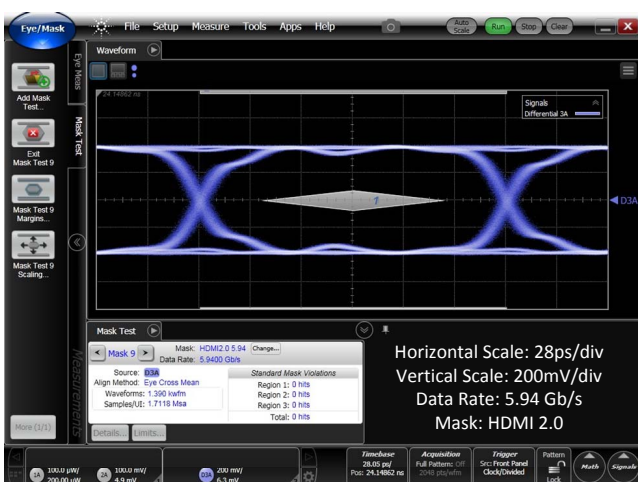

5.94Gb/s (HDMI 2.0) Eye Diagram without RClamp0561PQ

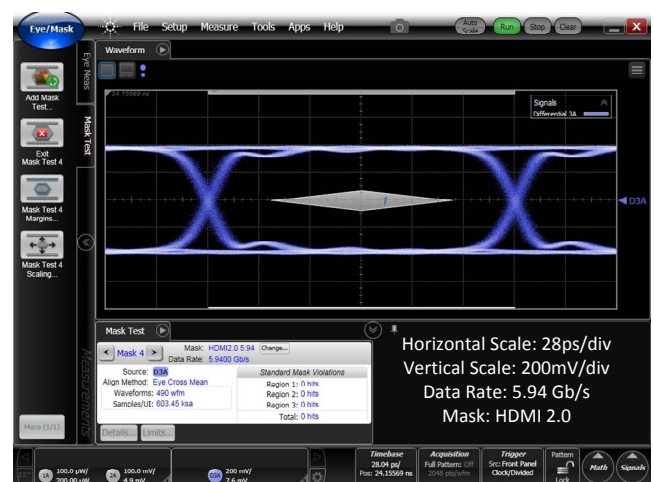

Application Information

USB Type-C Interface Protection

USB Type-C is a new 12-pin connector which supports USB 3.1 SuperSpeed+ (10Gb/s) connections and USB power delivery (USB PD). It is also backwards compatible (via an adaptor) with USB 3.0 and USB 2.0. The USB Type-C connector does not imply the use of USB 3.1 technology. USB Type-C is a connector shape. The underlying technology may be USB 2.0, USB 3.0, or USB 3.1. USB Type-C plugs are reversible (i.e. can be either be inserted right-side up or upside-down position) so there are connections on both the top and bottom of the PCB. The USB Type-C receptacle consists of 24-pins including: SuperSpeed RX and TX signal pairs, USB 2.0 DP and DM data pins, Auxiliary pins, Configuration pins, and Power and Ground Pins. Any of these connections are capable of conducting ESD current and should be protected.

Protection Solutions

SuperSpeed data line pairs are located on both the top and bottom of the PCB to support Type-C plug reversal (i.e. flip-ability). ESD protection of the SuperSpeed line pairs is achieved using one RClamp0561PQ between each line and ground. A total of eight devices are required. The low capacitance of RClamp0561PQ (0.18pF maximum) exhibits minimal effect on the transmission line impedance and excellent insertion loss characteristics (0.15dB loss at 5GHz). Single line devices make it easier for the designer to route the traces and maintain equal distance between the differential pairs

for maximum signal integrity. USB 2.0 pins support Type-C plug reversal by shorting together the D+ pins and D- pins in the plug receptacle. This means protection components only need to be placed on the side of the PCB where the traces are routed. RClamp0561PQ may also be used for protection of these lines. These devices can be used to protect the configuration channel (CC) and Sideband (SBU) pins. VBus pins are connected together within the Type-C plug and bussed together on the PCB. USB Type-C default power is fixed at 5V. Single line devices such as uClamp0571P are recommended for surge and ESD protection. Note that in power delivery (PD) applications, higher working voltage TVS devices may be needed. Options exist for ESD and surge protection up to 24V.

Examples of USB Type-C ESD protection topology using single line protection devices are shown in Figure 1 and Figure 2.

Device Placement

Placement of the protection component is a critical element for effective ESD suppression. TVS diodes should be placed as close to the connector as possible. This helps reduce transient coupling to nearby traces. Ground connections should be made directly to the ground plane using micro-vias. This reduces parasitic inductance in the ground path and minimizes the clamping voltage seen by the protected device.

Figure 1 - USB Type-C Top Layer Protection Example

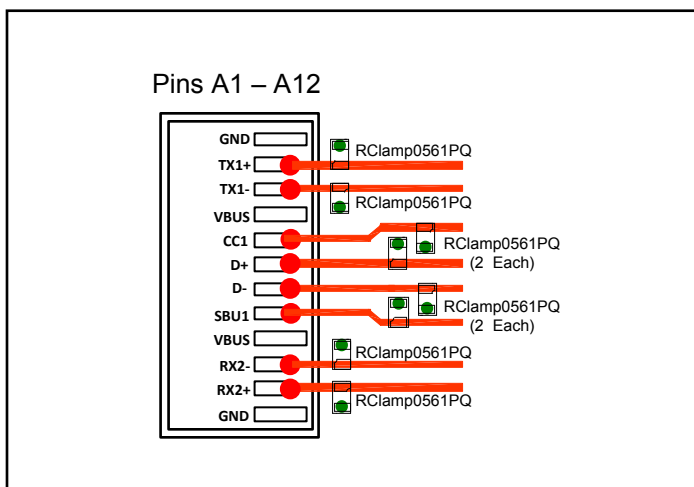
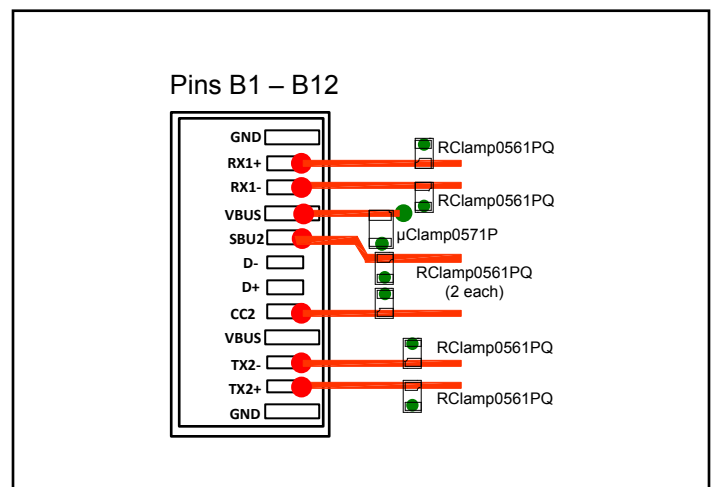
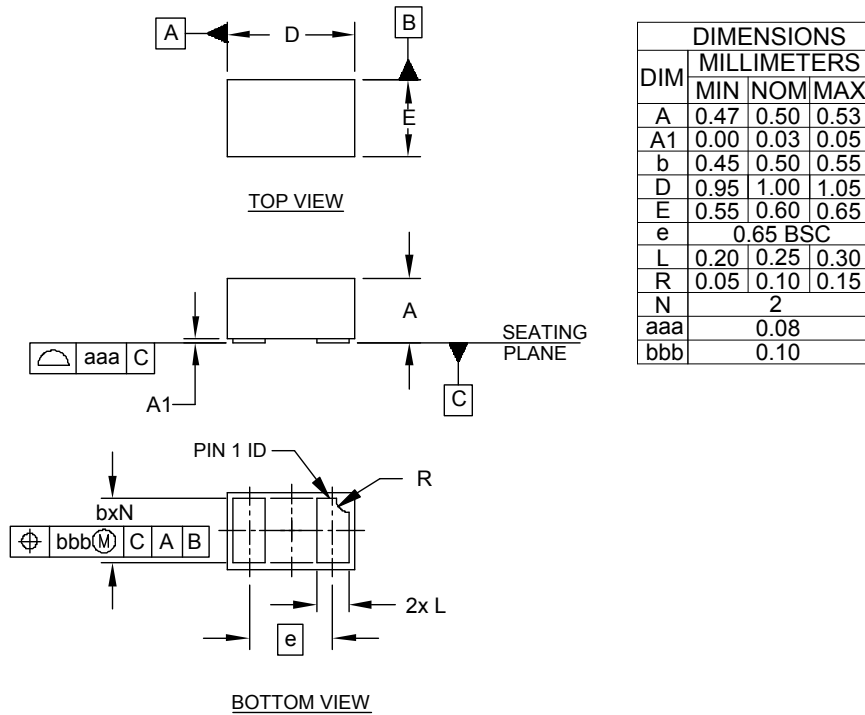

Figure 2 - USB Type-C Bottom Layer Protection Example



Outline Drawing - SLP1006P2



NOTES:

1. CONTROLLING DIMENSIONS ARE IN MILLIMETERS (ANGLES IN DEGREES).

Land Pattern - SLP1006P2

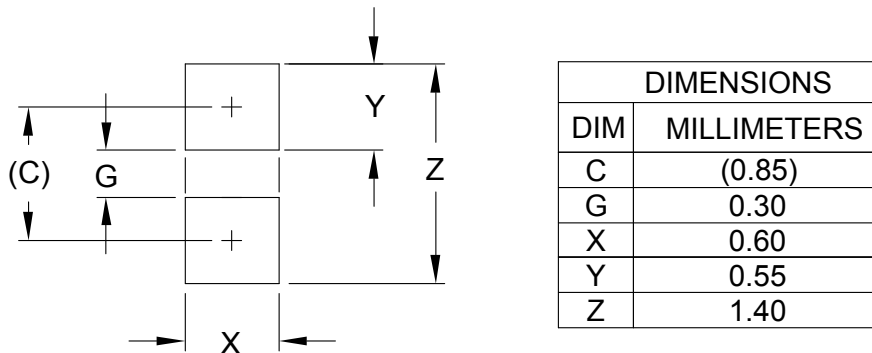

NOTES:

1. CONTROLLING DIMENSIONS ARE IN MILLIMETERS (ANGLES IN DEGREES).
2. THIS LAND PATTERN IS FOR REFERENCE PURPOSES ONLY. CONSULT YOUR MANUFACTURING GROUP TO ENSURE YOUR COMPANY'S MANUFACTURING GUIDELINES ARE MET.

Marking Code

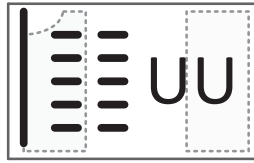

Notes:

- 1) Device is electrically symmetrical.
- 2) Marking includes line matrix date code
- 3) Bar indicates Pin 1 location

Tape and Reel Specification

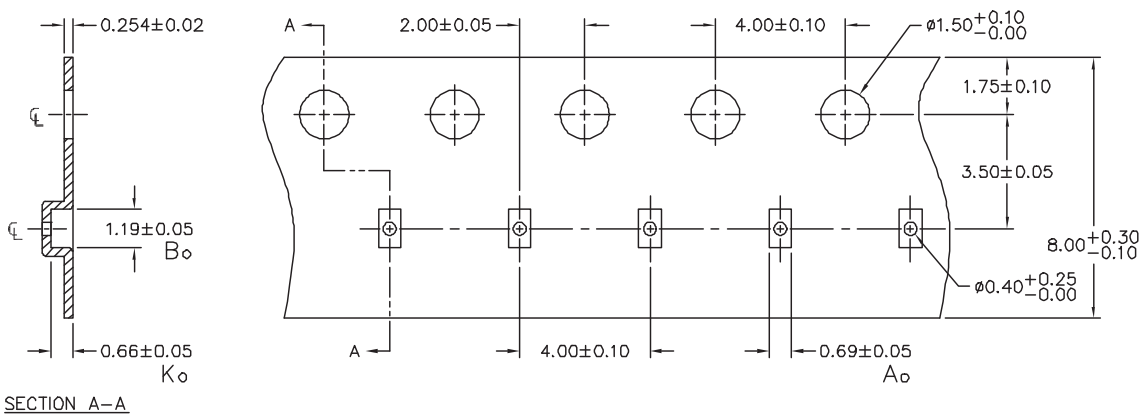

NOTES: 1.) ALL DIMENSIONS IN MILLIMETERS UNLESS OTHERWISE SPECIFIED.

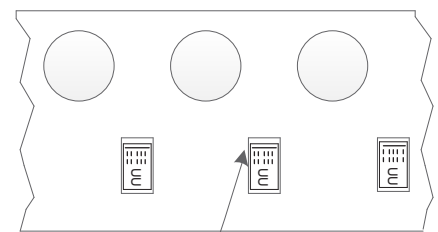

Marking Code Location
(Bar Towards Sprocket Holes)

Ordering Information

Part Number	Qty per Reel	Reel Size
RClamp0561PQTCT	3000	7 Inch

RailClamp and RClamp are registered trademarks of Semtech Corporation.



IMPORTANT NOTICE

Information relating to this product and the application or design described herein is believed to be reliable, however such information is provided as a guide only and Semtech assumes no liability for any errors in this document, or for the application or design described herein. Semtech reserves the right to make changes to the product or this document at any time without notice. Buyers should obtain the latest relevant information before placing orders and should verify that such information is current and complete. Semtech warrants performance of its products to the specifications applicable at the time of sale, and all sales are made in accordance with Semtech's standard terms and conditions of sale.

SEMTECH PRODUCTS ARE NOT DESIGNED, INTENDED, AUTHORIZED OR WARRANTED TO BE SUITABLE FOR USE IN LIFE-SUPPORT APPLICATIONS, DEVICES OR SYSTEMS, OR IN NUCLEAR APPLICATIONS IN WHICH THE FAILURE COULD BE REASONABLY EXPECTED TO RESULT IN PERSONAL INJURY, LOSS OF LIFE OR SEVERE PROPERTY OR ENVIRONMENTAL DAMAGE. INCLUSION OF SEMTECH PRODUCTS IN SUCH APPLICATIONS IS UNDERSTOOD TO BE UNDERTAKEN SOLELY AT THE CUSTOMER'S OWN RISK. Should a customer purchase or use Semtech products for any such unauthorized application, the customer shall indemnify and hold Semtech and its officers, employees, subsidiaries, affiliates, and distributors harmless against all claims, costs damages and attorney fees which could arise.

The Semtech name and logo are registered trademarks of the Semtech Corporation. All other trademarks and trade names mentioned may be marks and names of Semtech or their respective companies. Semtech reserves the right to make changes to, or discontinue any products described in this document without further notice. Semtech makes no warranty, representation or guarantee, express or implied, regarding the suitability of its products for any particular purpose. All rights reserved.

© Semtech 2015

Contact Information

Semtech Corporation
200 Flynn Road, Camarillo, CA 93012
Phone: (805) 498-2111, Fax: (805) 498-3804
www.semtech.com

X-ON Electronics

Largest Supplier of Electrical and Electronic Components

Click to view similar products for [ESD Suppressors / TVS Diodes](#) category:

Click to view products by [Semtech](#) manufacturer:

Other Similar products are found below :

[60KS200C](#) [D12V0H1U2WS-7](#) [D18V0L1B2LP-7B](#) [82356050220](#) [D5V0M5U6V-7](#) [NTE4902](#) [P4KE27CA](#) [P6KE11CA](#) [P6KE39CA-TP](#)
[P6KE8.2A](#) [SA110CA](#) [SA60CA](#) [SA64CA](#) [SMBJ12CATR](#) [SMBJ8.0A](#) [SMLJ30CA-TP](#) [ESD101-B1-02ELS E6327](#) [ESD112-B1-02EL E6327](#)
[ESD119B1W01005E6327XTSA1](#) [ESD5V0L1B02VH6327XTSA1](#) [ESD7451N2T5G](#) [19180-510](#) [CPDT-5V0USP-HF](#) [3.0SMCJ33CA-F](#)
[3.0SMCJ36A-F](#) [HSPC16701B02TP](#) [D3V3Q1B2DLP3-7](#) [D55V0M1B2WS-7](#) [DESD5V0U1BL-7B](#) [DRTR5V0U4SL-7](#) [SCM1293A-04SO](#)
[ESD200-B1-CSP0201 E6327](#) [ESD203-B1-02EL E6327](#) [SM12-7](#) [SMF8.0A-TP](#) [SMLJ45CA-TP](#) [CEN955 W/DATA](#) [82350120560](#)
[82356240030](#) [VESD12A1A-HD1-GS08](#) [CPDUR5V0R-HF](#) [CPDUR24V-HF](#) [CPDQC5V0U-HF](#) [CPDQC5V0USP-HF](#) [CPDQC5V0-HF](#)
[D1213A-01LP4-7B](#) [D1213A-02WL-7](#) [ESDLIN1524BJ-HQ](#) [5KP100A](#) [5KP15A](#)