

PROTECTION PRODUCTS - RailClamp®
Description

The RailClamp family is a series of ultra low capacitance Transient Voltage Suppressors (TVS) designed to protect high speed data interfaces. This series has been specifically designed to protect sensitive components which are connected to high-speed data and transmission lines from overvoltage caused by ESD (electrostatic discharge), CDE (Cable Discharge Events), and EFT (electrical fast transients).

The RClamp®1521PQ has a maximum capacitance of only 0.5pF. This allows it to be used on circuits operating in excess of 3GHz without signal attenuation. They may be used to meet the ESD immunity requirements of IEC 61000-4-2, Level 4 ($\pm 15\text{kV}$ air, $\pm 8\text{kV}$ contact discharge).

The RClamp1521PQ is in a 2-pin, RoHS/WEEE compliant, SLP1006P2 package measuring 1.0 x 0.6 x 0.5mm. The leads are spaced at a pitch of 0.65mm and feature a lead-free finish. Each device will protect one high-speed line operating at 15 volts. It gives the designer the flexibility to protect single lines in applications where arrays are not practical. The combination of small size, low capacitance, and high ESD surge capability makes them ideal for use in applications such as cellular phones and high-power USB.

The RClamp1521PQ is qualified to AEC-Q100 Grade 1 for Automotive use.

Features

- ◆ Transient protection for data lines to **IEC 61000-4-2 (ESD) $\pm 15\text{kV}$ (air), $\pm 8\text{kV}$ (contact)**
IEC 61000-4-4 (EFT) 40A (tp = 5/50ns)
Cable Discharge Event (CDE)
- ◆ Ultra-small package (1.0 x 0.6 x 0.5mm).
- ◆ Protects one data or I/O line.
- ◆ Low capacitance: 0.3pF typical.
- ◆ Low clamping voltage.
- ◆ Low operating voltage: 15V.
- ◆ Solid-state silicon-avalanche technology.
- ◆ AEC-Q100 Grade1 Qualified.

Mechanical Characteristics

- ◆ SLP1006P2 package.
- ◆ Molding compound flammability rating: UL 94V-0.
- ◆ Marking: Marking code.
- ◆ Packaging : Tape and Reel.
- ◆ Lead Finish: NiPdAu.
- ◆ RoHS/WEEE Compliant

Applications

- ◆ Cellular Handsets & Accessories.
- ◆ USB Ports.
- ◆ PCI Express.
- ◆ Serial ATA.
- ◆ Automotive Applications.

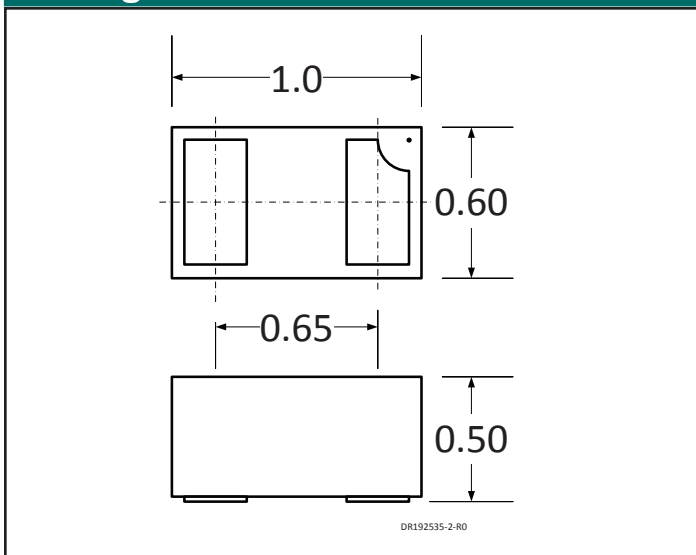
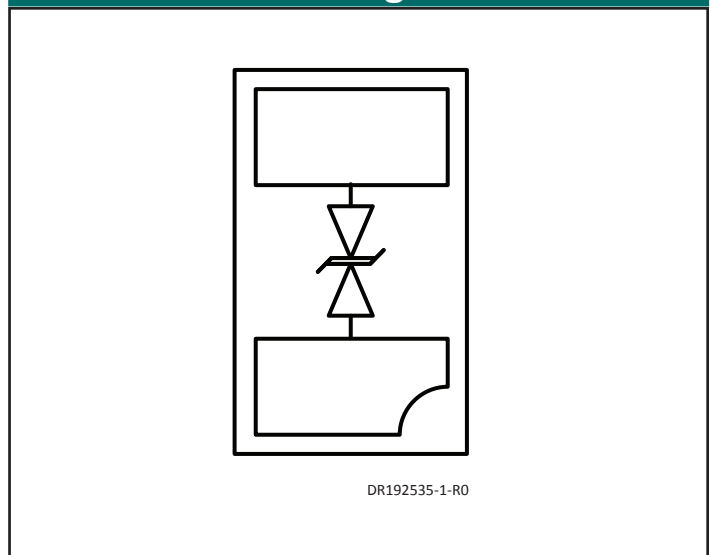
Package Dimensions

Schematic & Pin Configuration

PROTECTION PRODUCTS

Absolute Maximum Ratings

Rating	Symbol	Value	Units
Peak Pulse Power (tp = 8/20μs)	P _{PK}	120	W
Peak Pulse Current (tp = 8/20μs)	I _{PP}	4	A
ESD per IEC 61000-4-2 (Air)	V _{ESD}	±15	kV
ESD per IEC 61000-4-2 (Contact)		±8	
Operating Temperature	T _J	-40 to +125	°C
Storage Temperature	T _{STG}	-55 to +150	°C

Electrical Characteristics (T=25°C unless otherwise specified)

Parameter	Symbol	Conditions	Min.	Typ.	Max.	Units
Reverse Stand-Off Voltage	V _{RWM}	T = -40 to +125 °C			15	V
Reverse Breakdown Voltage	V _{BR}	I _t = 1mA T = -40 to +125 °C	16.7			V
Reverse Leakage Current	I _R	V _{RWM} = 15V,	T = 25 °C		1	uA
			T = 125 °C		5	
Clamping Voltage	V _C	I _{PP} = 1A, tp = 8/20μs			30	V
Clamping Voltage	V _C	I _{PP} = 4A, tp = 8/20μs			35	V
Junction Capacitance	C _J	V _R = 0V, f = 1MHz	T = 25 °C	0.30	0.50	pF
			T = 125 °C		1.00	

Non-Repetitive Peak Pulse Power vs. Pulse Time

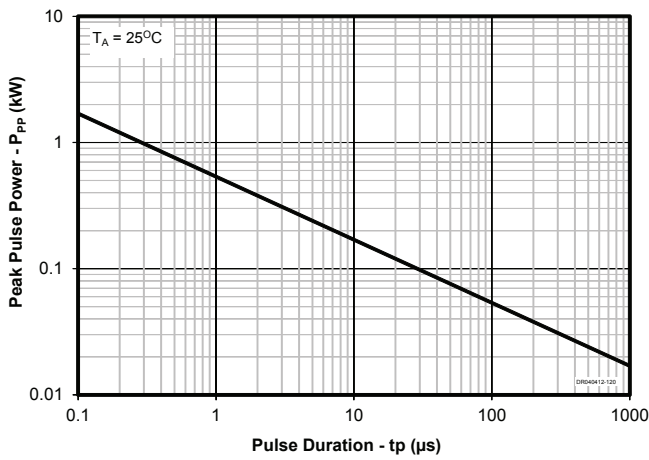

Power Derating Curve

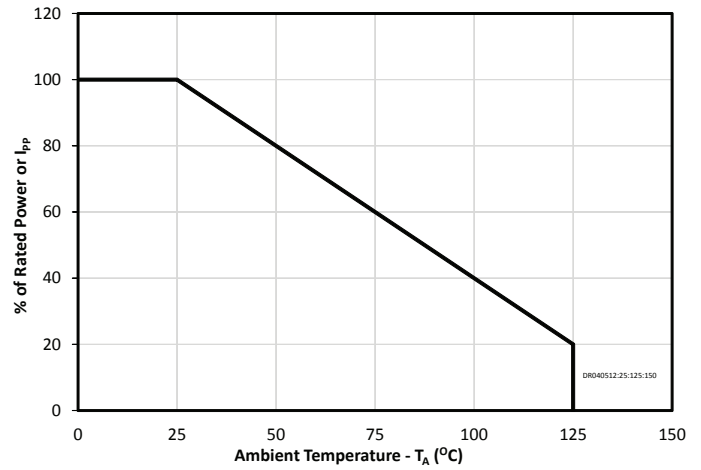

Reverse Leakage vs. Temperature

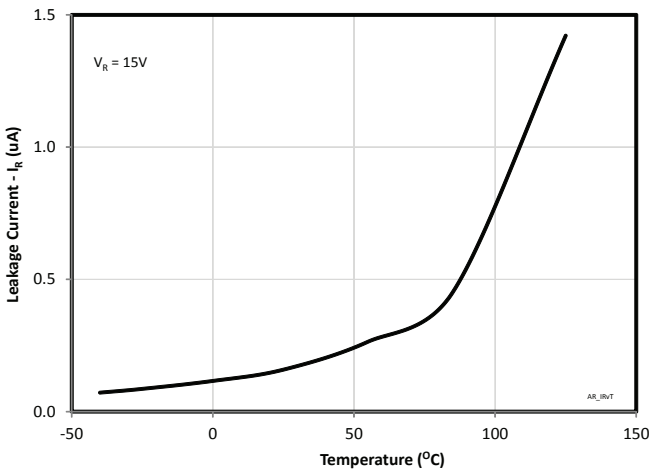

Reverse Leakage vs. Reverse Voltage

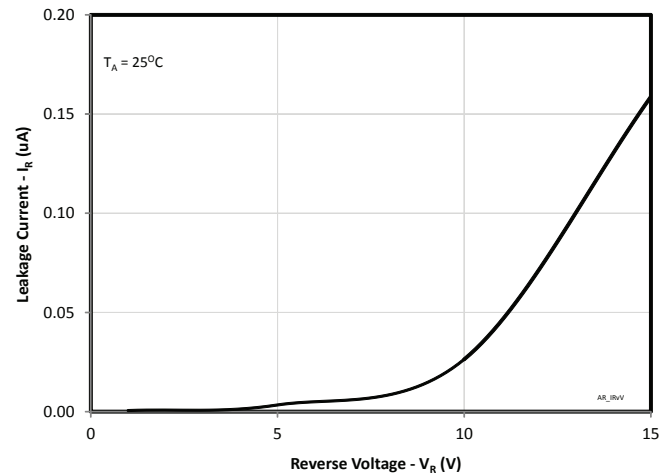

Capacitance vs. Temperature

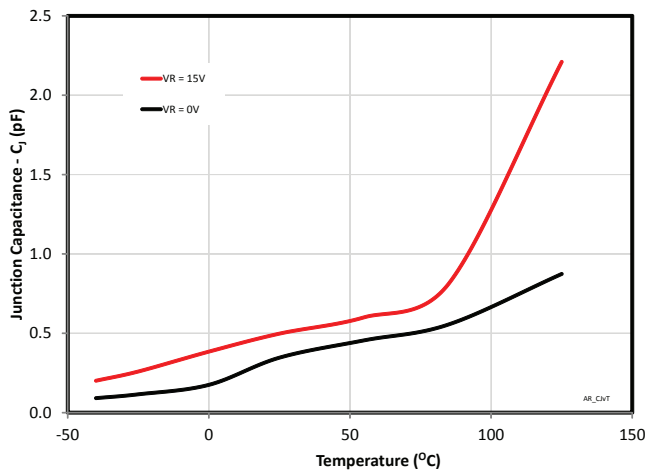

Breakdown Voltage vs. Temperature

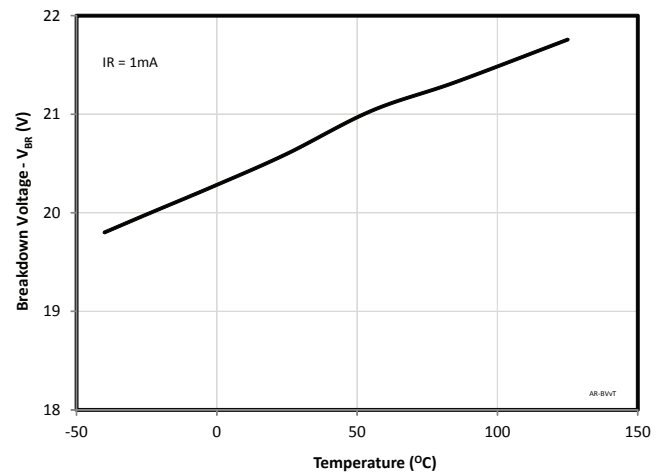

Typical Characteristics (Continued)

ESD Positive Clamp (8kV Contact per IEC 61000-4-2)

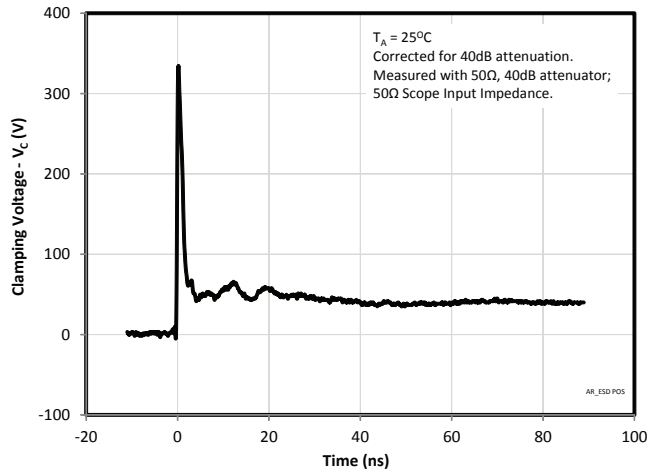

ESD Negative Clamp (8kV Contact per IEC 61000-4-2)

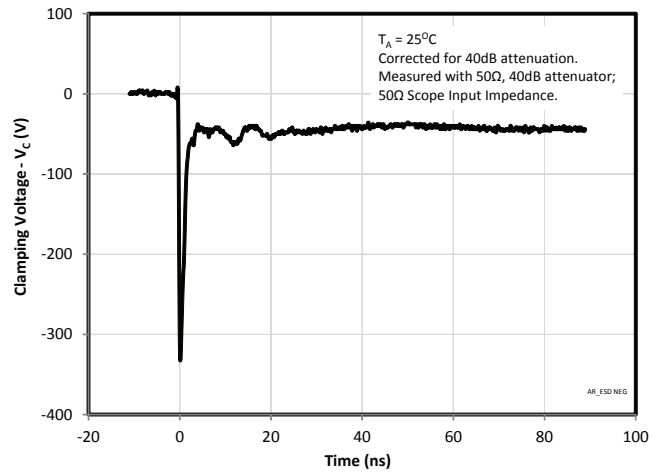

TLP IV Curve (Typical Either Direction)

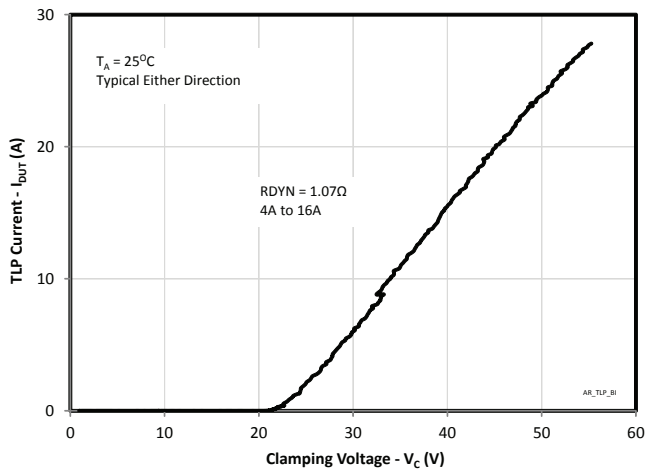

Device Connection Options

These low capacitance TVS diodes are designed to provide common mode protection for one high-speed line or differential protection for one line pair. The device is bidirectional and may be used on lines where the signal polarity is positive and negative.

Circuit Board Layout Recommendations for Suppression of ESD.

Good circuit board layout is critical for the suppression of ESD induced transients. The following guidelines are recommended:

- ◆ Place the TVS near the input terminals or connectors to restrict transient coupling.
- ◆ Minimize the path length between the TVS and the protected line.
- ◆ Minimize all conductive loops including power and ground loops.
- ◆ The ESD transient return path to ground should be kept as short as possible.
- ◆ Never run critical signals near board edges.
- ◆ Use ground planes whenever possible.

Equivalent Circuit Diagram

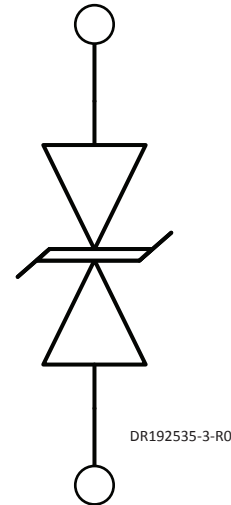

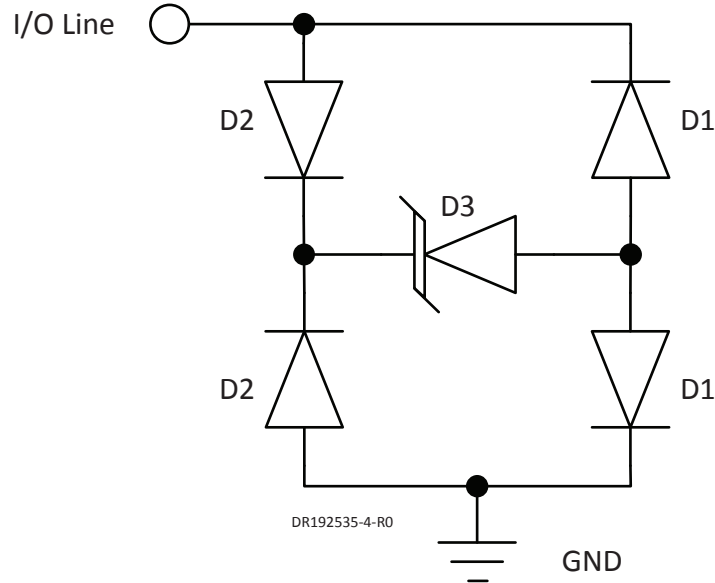

RClamp1521PQ Spice Model

RClamp1521PQ Spice Parameters				
Parameter	Unit	D1 (LCRD)	D2 (LCRD)	D3 (TVS)
IS	(A)	1.0E-20	1.0E-20	2.0E-12
BV	(V)	100	100	19.5
VJ	(V)	0.7	0.7	0.6
RS	(Ohm)	0.458	0.89	0.8
IBV	(A)	1E-3	1E-3	1E-3
CJO	(F)	0.4E-12	0.4E-12	56E-12
TT	(s)	2.541E-9	2.541E-9	2.541E-9
M	--	0.01	0.01	0.23
N	--	1.1	1.1	1.1
EG	(eV)	1.11	1.11	1.11

PROTECTION PRODUCTS

Outline Drawing - {Insert Package Type}

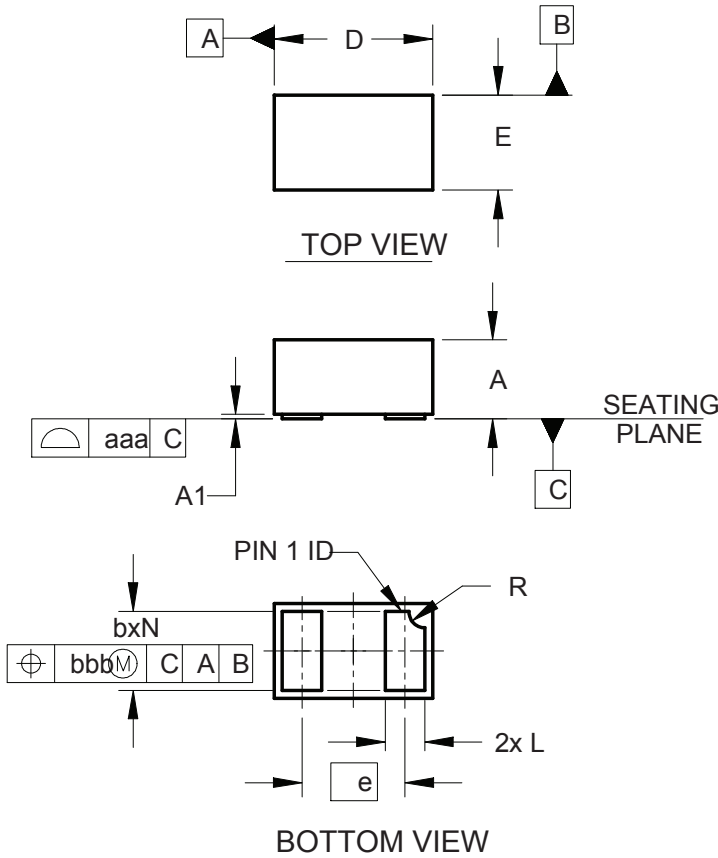

DIMENSIONS						
DIM	INCHES			MILLIMETERS		
	MIN	NOM	MAX	MIN	NOM	MAX
A	.016	.020	.022	0.40	0.50	0.55
A1	.000	.001	.002	0.00	0.03	0.05
b	.018	.020	.022	0.45	0.50	0.55
D	.035	.039	.043	0.90	1.00	1.10
E	.020	.024	.028	0.50	0.60	0.70
e	.026 BSC			0.65 BSC		
L	.008	.010	.012	0.20	0.25	0.30
R	.002	.004	.006	0.05	0.10	0.15
N	2			2		
aaa	.003			0.08		
bbb	.004			0.10		

DR192536-1-R0

- NOTES:
1. CONTROLLING DIMENSIONS ARE IN MILLIMETERS (ANGLES IN DEGREES).

Land Pattern - {Insert Package Type}

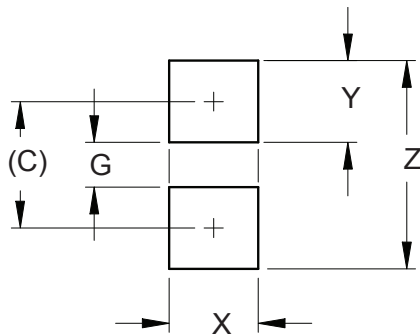

DIMENSIONS		
DIM	INCHES	MILLIMETERS
C	(.033)	(0.85)
G	.012	0.30
X	.024	0.60
Y	.022	0.55
Z	.055	1.40

DR192536-2-R0

- NOTES:
1. CONTROLLING DIMENSIONS ARE IN MILLIMETERS (ANGLES IN DEGREES).
2. THIS LAND PATTERN IS FOR REFERENCE PURPOSES ONLY. CONSULT YOUR MANUFACTURING GROUP TO ENSURE YOUR COMPANY'S MANUFACTURING GUIDELINES ARE MET.

PROTECTION PRODUCTS

Marking

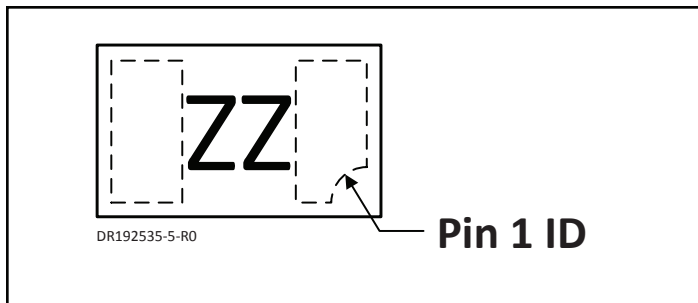

Ordering Information

Part Number	Qty per Reel	Reel Size
RClamp1521PQTCT	3000	7 Inch

Note: Lead finish is lead-free NiPdAu
 RailClamp and RClamp are marks of Semtech Corporation.

Tape and Reel Specification

10 Pitches Cumulative Tolerance on Tape $\pm 0.2\text{mm}$ ($\pm 0.008''$)

Top Cover Tape

Pin 1 Location (towards sprocket holes)

Embossment

Center Lines of Cavity

User Direction of Feed

DR192533-1-R0

DR192535-6-R0

A0	B0	K0	B1	D	D1	E	F	K	P	P0	P2	t	W
0.69 ± 0.10	1.19 ± 0.10	0.66 ± 0.10	Not Spec'd	1.50 $+0.1$ -0.0	Not Spec'd	1.75 ± 0.10	3.50 ± 0.05	Not Spec'd	4.00 ± 0.10	4.00 ± 0.10	2.00 ± 0.05	Not Spec'd	8.0 $+0.3$ -0.1

Ref KCT00078 Rev0

Contact Information for Semtech International AG

Taiwan Branch	Tel: 886-2-2748-3380 Fax: 886-2-2748-3390	Japan (Tokyo) Office	Tel: 81-3-5719-7560 Fax: 81-3-5719-7561
Korea Branch	Tel: 82-2-527-4377 Fax: 82-2-527-4376	Semtech Limited (U.K.)	Tel: 44-1794-527-600 Fax: 44-1794-527-601
Shanghai Office	Tel: 86-21-6391-0830 Fax: 86-21-6391-0831	Semtech France SARL	Tel: 33-(0)169-28-22-00 Fax: 33-(0)169-28-12-98
Japan (Osaka) Office	Tel: 81-6-6347-6570 Fax: 81-6-6347-6571	Semtech Germany GmbH	Tel: 49-(0)8161-140-123 Fax: 49-(0)8161-140-124

Semtech International AG is a wholly-owned subsidiary of Semtech Corporation, which has its headquarters in the U.S.A.

X-ON Electronics

Largest Supplier of Electrical and Electronic Components

Click to view similar products for [ESD Suppressors / TVS Diodes](#) category:

Click to view products by [Semtech](#) manufacturer:

Other Similar products are found below :

[60KS200C](#) [D12V0H1U2WS-7](#) [D18V0L1B2LP-7B](#) [82356050220](#) [D5V0M5U6V-7](#) [NTE4902](#) [P4KE27CA](#) [P6KE11CA](#) [P6KE39CA-TP](#)
[P6KE8.2A](#) [SA110CA](#) [SA60CA](#) [SA64CA](#) [SMBJ12CATR](#) [SMBJ8.0A](#) [SMLJ30CA-TP](#) [ESD101-B1-02ELS E6327](#) [ESD112-B1-02EL E6327](#)
[ESD119B1W01005E6327XTSA1](#) [ESD5V0L1B02VH6327XTSA1](#) [ESD7451N2T5G](#) [19180-510](#) [CPDT-5V0USP-HF](#) [3.0SMCJ33CA-F](#)
[3.0SMCJ36A-F](#) [HSPC16701B02TP](#) [D3V3Q1B2DLP3-7](#) [D55V0M1B2WS-7](#) [DESD5V0U1BL-7B](#) [DRTR5V0U4SL-7](#) [SCM1293A-04SO](#)
[ESD200-B1-CSP0201 E6327](#) [ESD203-B1-02EL E6327](#) [SM12-7](#) [SMF8.0A-TP](#) [SMLJ45CA-TP](#) [CEN955 W/DATA](#) [82350120560](#)
[82356240030](#) [VESD12A1A-HD1-GS08](#) [CPDUR5V0R-HF](#) [CPDUR24V-HF](#) [CPDQC5V0U-HF](#) [CPDQC5V0USP-HF](#) [CPDQC5V0-HF](#)
[D1213A-01LP4-7B](#) [D1213A-02WL-7](#) [ESDLIN1524BJ-HQ](#) [5KP100A](#) [5KP15A](#)