

PROTECTION PRODUCTS - RailClamp®

Description

RailClamps are ultra low capacitance TVS arrays designed to protect high speed data interfaces. This series has been specifically designed to protect sensitive components which are connected to high-speed data and transmission lines from overvoltage caused by **ESD** (electrostatic discharge), **CDE** (Cable Discharge Events), and **EFT** (electrical fast transients).

The RClamp™2402B has a typical capacitance of only 0.60pF (pin 1 to 2). This means it can be used on circuits operating in excess of 3GHz without signal attenuation. They may be used to meet the ESD immunity requirements of IEC 61000-4-2, Level 4 ($\pm 15\text{kV}$ air, $\pm 8\text{kV}$ contact discharge). Each device can be configured to protect one bidirectional line or two unidirectional lines.

These devices are in a small SC-75 (SOT-523) package and feature a lead-free, matte tin finish. They are compatible with both lead free and SnPb assembly techniques. They are designed for use in applications where board space is at a premium. The combination of small size, low capacitance, and high level of ESD protection makes them a flexible solution for applications such as HDMI, antenna circuits, Automatic Test Equipment, USB 2.0, and Infiniband circuits.

Features

- ◆ Transient protection for high-speed data lines to **IEC 61000-4-2 (ESD) $\pm 15\text{kV}$ (air), $\pm 8\text{kV}$ (contact)**
IEC 61000-4-4 (EFT) 40A (5/50ns)
- ◆ Designed to replace polymer TVS
- ◆ Protects up to two I/O lines
- ◆ Ultra-Low Line-to-Line capacitance (**<0.5pF Typical**)
- ◆ No insertion loss to **>3.0GHz**
- ◆ Low profile (<1mm)
- ◆ Low leakage current and clamping voltage
- ◆ Low operating voltage: 24.0V
- ◆ Solid-state silicon-avalanche technology

Mechanical Characteristics

- ◆ SC-75 (SOT-523) package
- ◆ Lead Finish: Matte Tin
- ◆ RoHS/WEEE Compliant
- ◆ Molding compound flammability rating: UL 94V-0
- ◆ Marking: P7
- ◆ Packaging: Tape and Reel per EIA 481

Applications

- ◆ High-Definition Multimedia Interface (HDMI)
- ◆ USB 2.0 & Firewire Ports
- ◆ GaAs Photodetector Protection
- ◆ HBT Power Amp Protection
- ◆ Infiniband Transceiver Protection

Dimensions

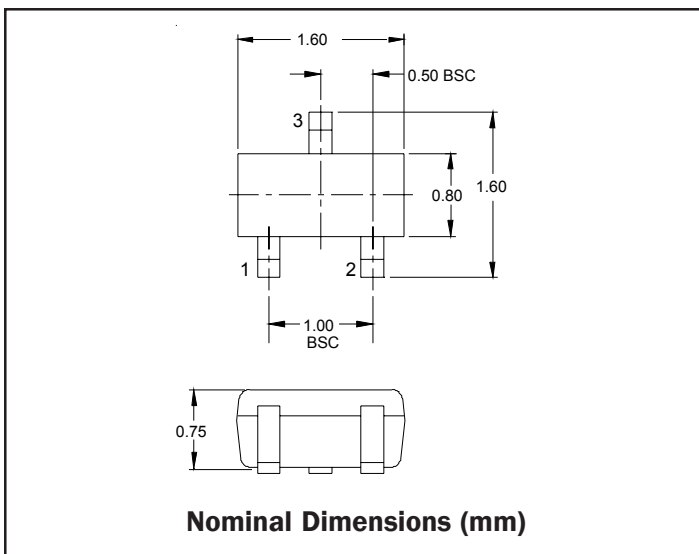

Schematic & PIN Configuration

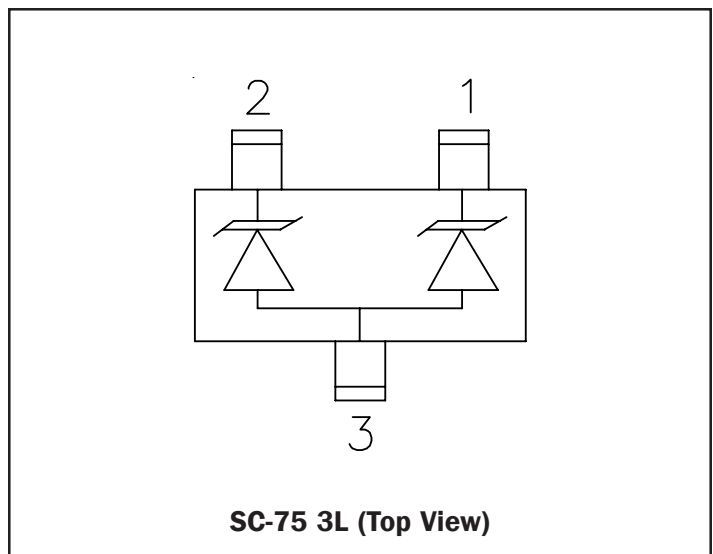

PROTECTION PRODUCTS
Absolute Maximum Rating

Rating	Symbol	Value	Units
Peak Pulse Power (tp = 8/20μs)	P_{pk}	200	Watts
Peak Pulse Current (tp = 8/20μs)	I_{pp}	4	A
ESD per IEC 61000-4-2 (Air) ESD per IEC 61000-4-2 (Contact)	V_{ESD}	25 15	kV
Operating Temperature	T_J	-55 to +125	°C
Storage Temperature	T_{STG}	-55 to +150	°C

Electrical Characteristics (T=25°C)

Parameter	Symbol	Conditions	Minimum	Typical	Maximum	Units
Reverse Stand-Off Voltage	V_{RWM}	Pin 1 or Pin 2 to Pin 3 and Between Pins 1 and 2			24	V
Reverse Breakdown Voltage	V_{BR}	$I_t = 1mA$ Pin 1 or Pin 2 to Pin 3 and Between Pins 1 and 2	26.7			V
Reverse Leakage Current	I_R	$V_{RWM} = 24V, T=25^\circ C$ Pin 1 or Pin 2 to Pin 3 and Between Pins 1 and 2			1	μA
Clamping Voltage	V_C	$I_{pp} = 1A, tp = 8/20\mu s$ Pin 1 to Pin 2			45	V
Clamping Voltage	V_C	$I_{pp} = 4A, tp = 8/20\mu s$ Pin 1 or Pin 2 to Pin 3			50	V
Clamping Voltage	V_C	$I_{pp} = 4A, tp = 8/20\mu s$ Pin 1 to Pin 2			55	V
Junction Capacitance	C_j	$V_R = 0V, f = 1MHz$ Pin 1 to Pin 2		0.60	0.9	pF
Junction Capacitance	C_j	$V_R = 0V, f = 1MHz$ Pin 1 or Pin 2 to Pin 3			1.5	pF

PROTECTION PRODUCTS

Typical Characteristics

Non-Repetitive Peak Pulse Power vs. Pulse Time

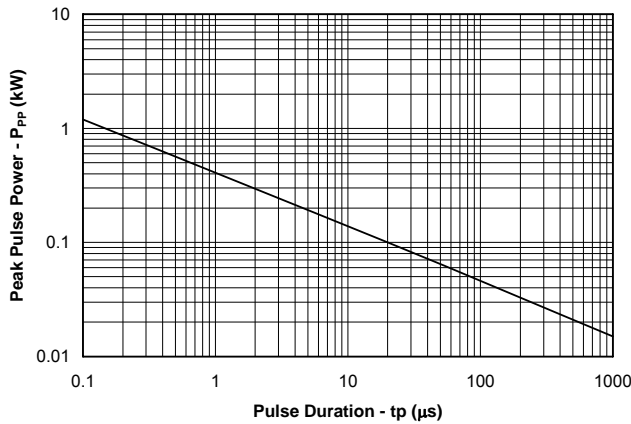

Power Derating Curve

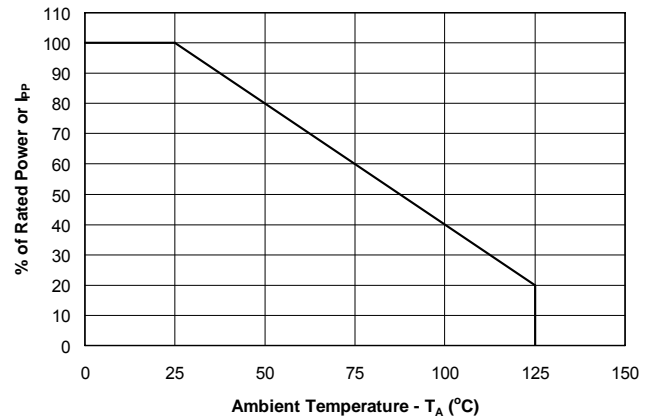

Clamping Voltage vs. Peak Pulse Current Pin 1 to Pin 2

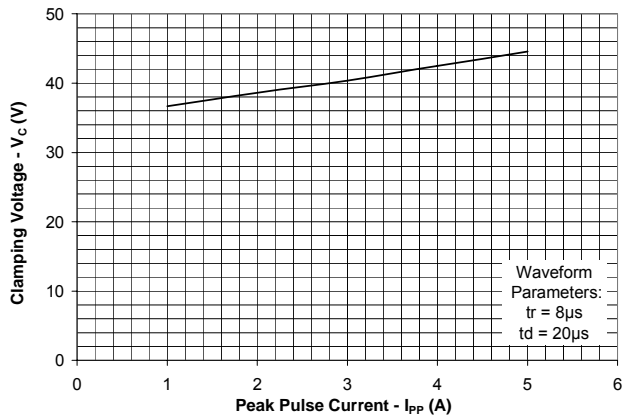

Clamping Voltage vs. Peak Pulse Current Pin 1 or Pin 2 to Pin 3

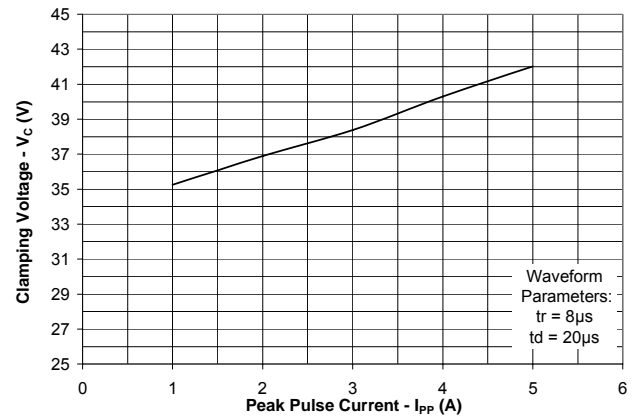

Normalized Capacitance vs. Reverse Voltage Pin 1 or Pin 2 to Pin 3

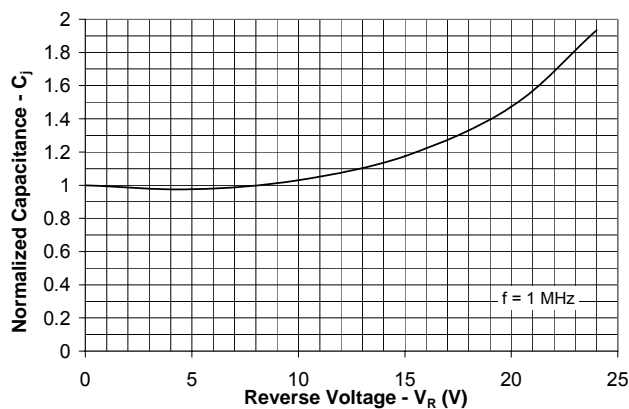

Normalized Capacitance vs. Reverse Voltage Pin 1 to Pin 2

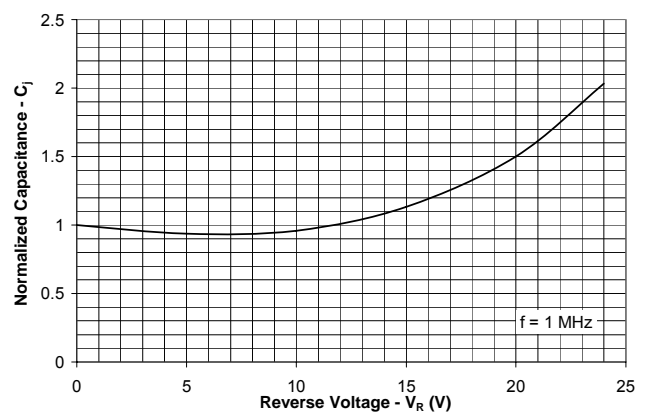

PROTECTION PRODUCTS

Typical Characteristics

Insertion Loss S21 (Pin 1 to Pin 2)

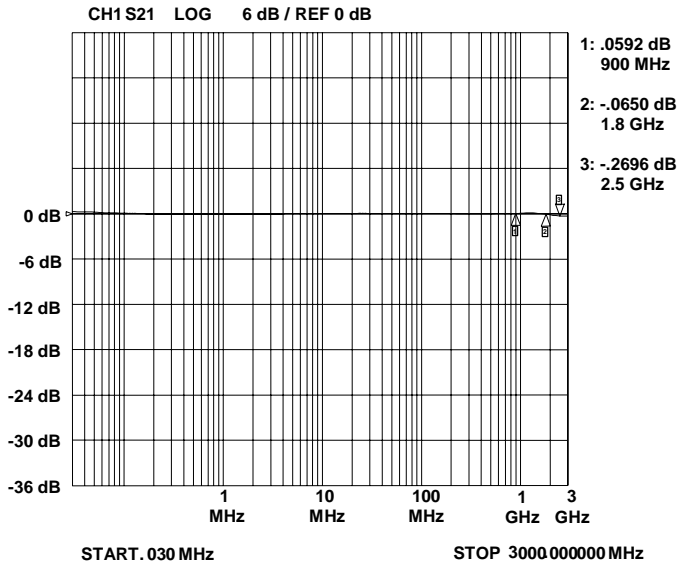

Insertion Loss S21 (Pin 1 or Pin 2 to Pin 3)

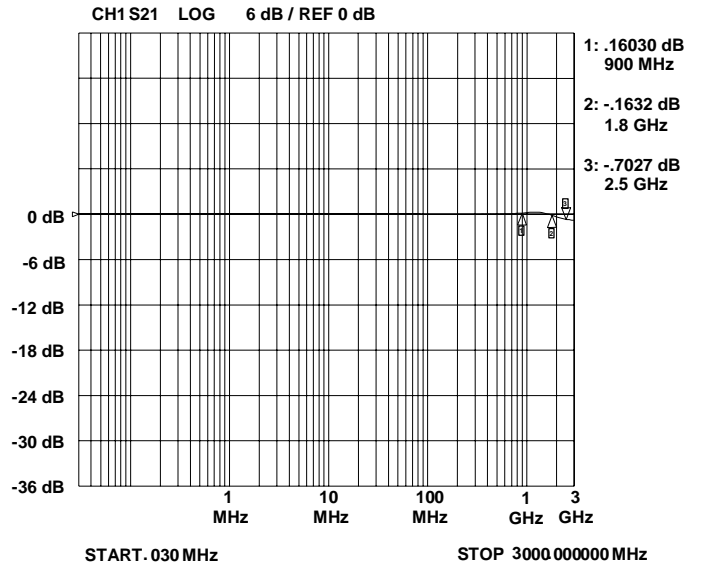

ESD Response (4kV Contact per IEC 61000-4-2)

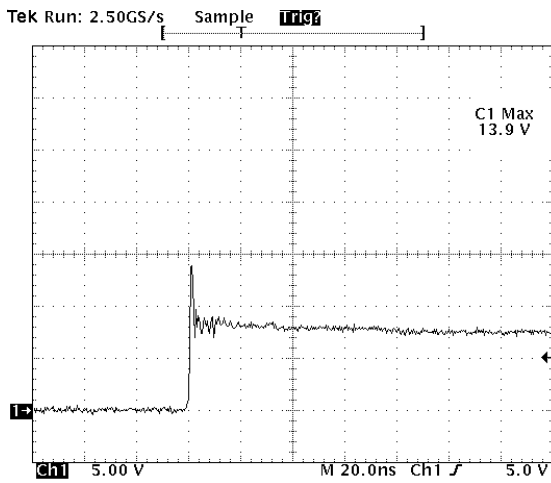

ESD Response (8kV Contact per IEC 61000-4-2)

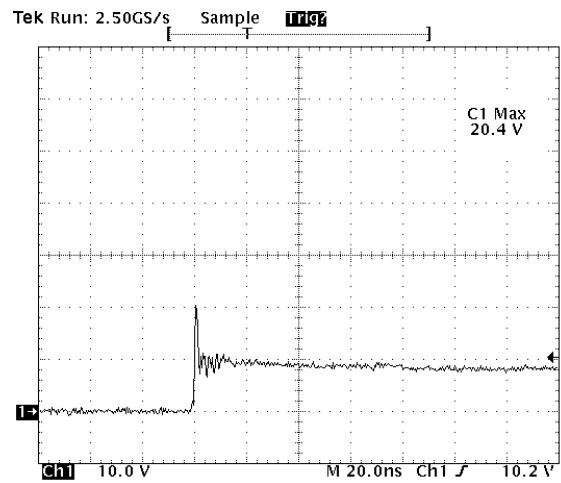

Analog Crosstalk

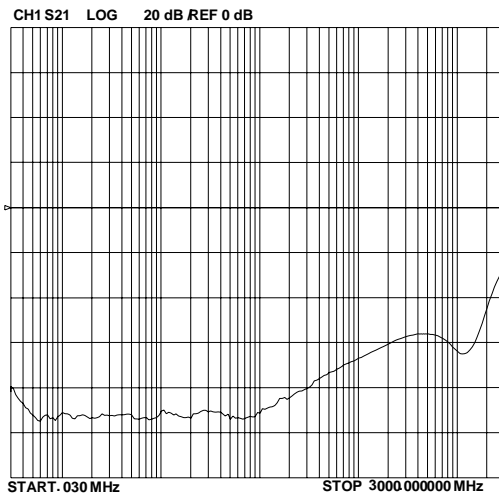

PROTECTION PRODUCTS**Applications Information****Device Connection Options**

This device is optimized for protection of 1 line operating in excess of 3GHz. It may also be used to protect two lines operating in excess of 2.0GHz. The device is connected as follows:

Protection for one line with $<1\text{pF}$ capacitance can be achieved by connecting one data line to either pin 1 or pin 2 with the other pin connected to ground. Pin 3 is not connected. The connection to ground should be made directly to a ground plane. The path length should also be kept as short as possible to minimize parasitic inductance.

Protection of two lines is achieved by connecting data lines at pins 1 & 2. Pin 3 is connected to ground. The connection to ground should be made directly to a ground plane. The path length should also be kept as short as possible to minimize parasitic inductance.

Matte Tin Lead Finish

Matte tin has become the industry standard lead-free replacement for SnPb lead finishes. A matte tin finish is composed of 100% tin solder with large grains. Since the solder volume on the leads is small compared to the solder paste volume that is placed on the land pattern of the PCB, the reflow profile will be determined by the requirements of the solder paste. Therefore, these devices are compatible with both lead-free and SnPb assembly techniques. In addition, unlike other lead-free compositions, matte tin does not have any added alloys that can cause degradation of the solder joint.

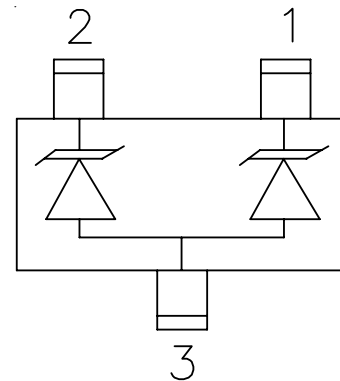
Figure 1. Pin Configuration

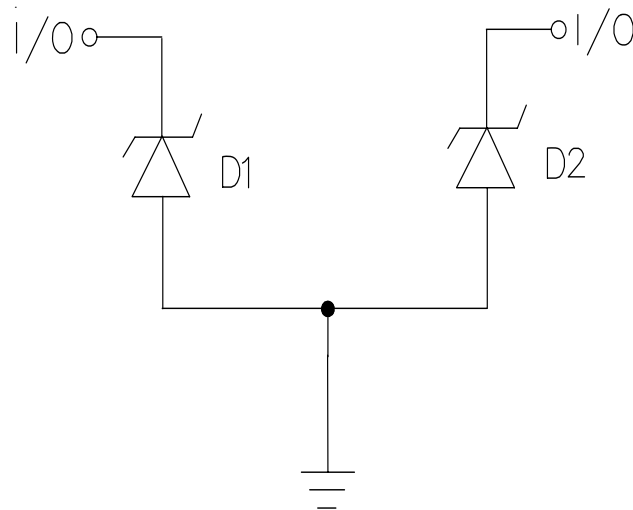
PROTECTION PRODUCTS
Applications Information - Spice Model

RClamp2402B Spice Model
Table 1 - RClamp2402B Spice Parameters

Parameter	Unit	D1 (TVS)	D2 (TVS)
IS	Amp	1.93E-14	1.93E-14
BV	Volt	32.4	32.4
VJ	Volt	0.68	0.68
RS	Ohm	2.04	2.04
IBV	Amp	1.0E-3	1.0E-3
CJO	Farad	0.73E-12	0.73E-12
TT	sec	2.541E-9	2.541E-9
M	--	0.412	0.412
N	--	1.1	1.1
EG	eV	1.11	1.11

PROTECTION PRODUCTS

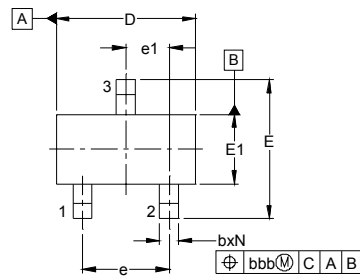
Outline Drawing -SC-75 (SOT-523)



DIM	INCHES			MILLIMETERS		
	MIN	NOM	MAX	MIN	NOM	MAX
A	.023	-	.035	0.60	-	0.90
A1	.000	-	.004	0.00	-	0.10
A2	.023	.030	.031	0.60	0.75	0.80
b	.005	-	.012	0.15	-	0.30
c	.003	-	.008	0.10	-	0.20
D	.059	.063	.067	1.50	1.60	1.70
E	.057	.063	.069	1.45	1.60	1.75
E1	.029	.031	.033	0.75	0.80	0.85
e	.039 BSC			1.00 BSC		
e1	.020 BSC			0.50 BSC		
L	(.009)			(0.22)		
N	3			3		
φ	0°	-	8°	0°	-	8°
aaa	.004			0.10		
bbb	.008			0.20		

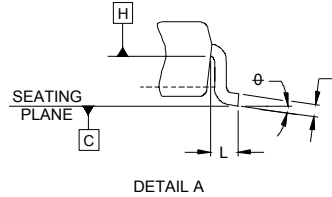
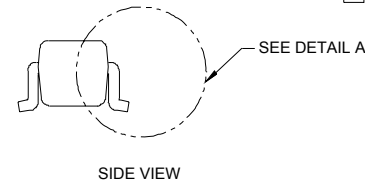
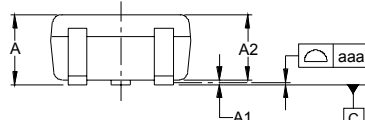

NOTES:

1. CONTROLLING DIMENSIONS ARE IN MILLIMETERS (ANGLES IN DEGREES).
2. DATUMS **-A-** AND **-B-** TO BE DETERMINED AT DATUM PLANE **-H-**
3. DIMENSIONS "E1" AND "D" DO NOT INCLUDE MOLD FLASH, PROTRUSIONS OR GATE BURRS.

Land Pattern -SC-75 (SOT-523)

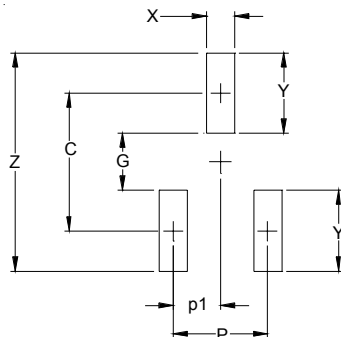

DIM	DIMENSIONS	
	INCHES	MILLIMETERS
C	(.055)	(1.40)
P	.039	1.00
p1	.020	0.50
G	.024	0.60
X	.016	0.40
Y	.031	0.80
Z	.087	2.20

NOTES:

1. THIS LAND PATTERN IS FOR REFERENCE PURPOSES ONLY CONSULT YOUR MANUFACTURING GROUP TO ENSURE YOUR COMPANY'S MANUFACTURING GUIDELINES ARE MET.

PROTECTION PRODUCTS

Marking

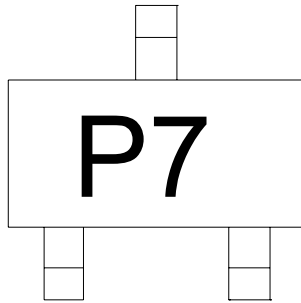

Ordering Information

Part Number	Lead Finish	Qty per Reel	Reel Size
RClamp2402B.TCT	Pb Free	3,000	7 Inch

RailClamp and RClamp are registered marks of Semtech Corporation

Tape and Reel Specification

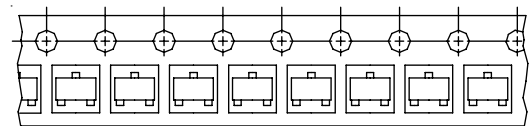
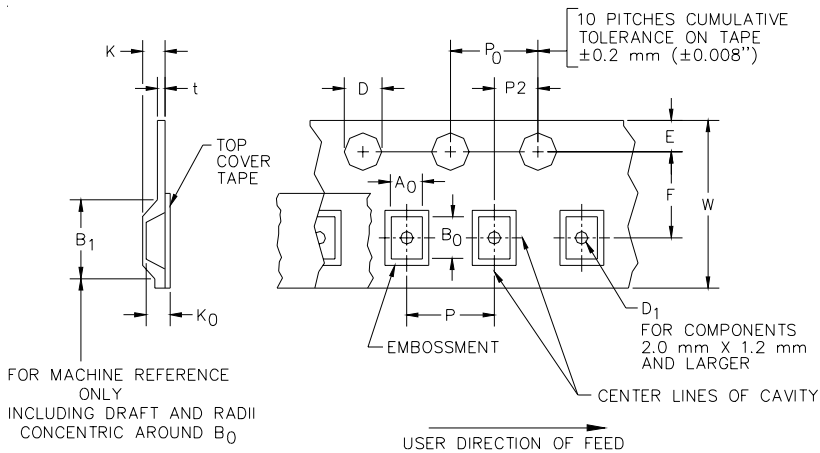

Device Orientation in Tape

Tape Width	B, (Max)	D	D1 (MIN)	E	F	K (MAX)	P	P0	P2	T(MAX)	W
8 mm	4.2 mm (.165)	1.5 + 0.1 mm - 0.0 mm (0.59 +.005 - .000)	1.0 mm (.039)	1.750±.10 mm (.069±.004)	3.5±0.05 mm (.138±.002)	2.4 mm (.094)	4.0±0.1 mm (.157±.00-4)	4.0±0.1 mm (.157±.00-4)	2.0±0.05mm (.079±.002)	0.4 mm (.016)	8.3 mm (.312±.012)

Contact Information

Semtech Corporation
 Protection Products Division
 200 Flynn Rd., Camarillo, CA 93012
 Phone: (805)498-2111 FAX (805)498-3804

X-ON Electronics

Largest Supplier of Electrical and Electronic Components

Click to view similar products for [ESD Suppressors / TVS Diodes](#) category:

Click to view products by [Semtech](#) manufacturer:

Other Similar products are found below :

[60KS200C](#) [D12V0H1U2WS-7](#) [D18V0L1B2LP-7B](#) [82356050220](#) [D5V0M5U6V-7](#) [NTE4902](#) [P4KE27CA](#) [P6KE11CA](#) [P6KE39CA-TP](#)
[P6KE8.2A](#) [SA110CA](#) [SA60CA](#) [SA64CA](#) [SMBJ12CATR](#) [SMBJ8.0A](#) [SMLJ30CA-TP](#) [ESD101-B1-02ELS E6327](#) [ESD112-B1-02EL E6327](#)
[ESD119B1W01005E6327XTSA1](#) [ESD5V0L1B02VH6327XTSA1](#) [ESD7451N2T5G](#) [19180-510](#) [CPDT-5V0USP-HF](#) [3.0SMCJ33CA-F](#)
[3.0SMCJ36A-F](#) [HSPC16701B02TP](#) [D3V3Q1B2DLP3-7](#) [D55V0M1B2WS-7](#) [DESD5V0U1BL-7B](#) [DRTR5V0U4SL-7](#) [SCM1293A-04SO](#)
[ESD200-B1-CSP0201 E6327](#) [ESD203-B1-02EL E6327](#) [SM12-7](#) [SMF8.0A-TP](#) [SMLJ45CA-TP](#) [CEN955 W/DATA](#) [82350120560](#)
[82356240030](#) [VESD12A1A-HD1-GS08](#) [CPDUR5V0R-HF](#) [CPDUR24V-HF](#) [CPDQC5V0U-HF](#) [CPDQC5V0USP-HF](#) [CPDQC5V0-HF](#)
[D1213A-01LP4-7B](#) [D1213A-02WL-7](#) [ESDLIN1524BJ-HQ](#) [5KP100A](#) [5KP15A](#)