

### PROTECTION PRODUCTS

#### Description

RClamp®7534P is a high performance TVS array aimed at simultaneously protecting 4 signal lines from overvoltage events caused by ESD, CDE (Cable Discharge Events) and EFT (electrical fast transients). RClamp7534P features an extremely low typical capacitance of 0.19pF and is designed to protect high speed interfaces such as HDMI 2.0, Ethernet, and USB 3.0.

RClamp7534P is a bi-directional device designed to provide extremely low clamping voltage for both positive and negative ESD pulses. With a typical dynamic resistance of 1.0 Ohm, the RClamp7534P turns on quickly during overvoltage events to protect sensitive systems.

RClamp7534P is in a 5-pin SGP2010N5 package measuring 2.0 x 1.0mm with a nominal height of 0.50mm. The leads have a nominal pin-to-pin pitch of 0.40mm. Flow-through package design simplifies PCB layout and maintains signal integrity on high-speed lines. The combination of low peak ESD clamping, low dynamic resistance, and innovative package design enables this device to provide the highest level of ESD protection.

#### Nominal Dimensions

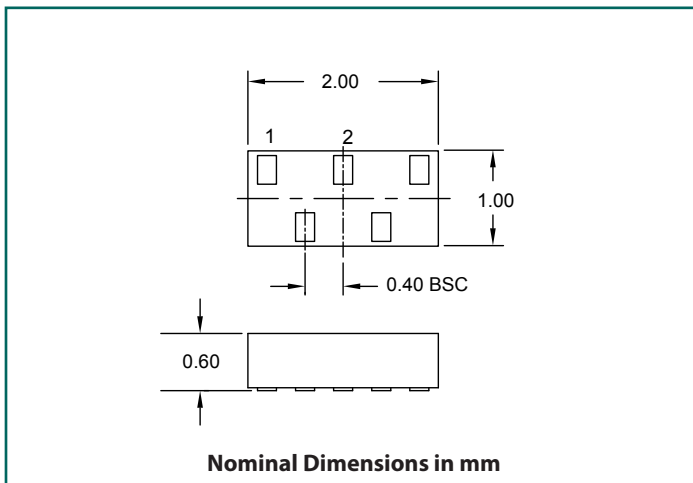

#### Features

- ESD protection for high-speed data lines to
- IEC 61000-4-2 (ESD)  $\pm 25\text{kV}$  (air),  $\pm 20\text{kV}$  (contact)
- IEC 61000-4-5 (Lightning) 4A (8/20 $\mu\text{s}$ )
- IEC 61000-4-4 (EFT) 40A (5/50ns)
- Package design optimized for high speed lines
- Protects four high-speed lines
- Low capacitance: 0.19pF Typical (I/O to Ground)
- Low ESD clamping voltage
- Low dynamic resistance: 1.0 Ohm (Typ)
- Low leakage current
- Solid-state silicon-avalanche technology

#### Mechanical Characteristics

- SGP2010N5 Package (2.0 x 1.0 x 0.50mm)
- Pb-Free, Halogen Free, RoHS/WEEE Compliant
- Lead Finish: NiPdAu
- Marking : Marking Code
- Packaging : Tape and Reel

#### Applications

- HDMI 2.0
- USB 3.1
- Display Port 1.2
- Thunderbolt
- 1G / 2.5G / 5G / 10G Ethernet
- V-By-One
- MHL

#### Schematic

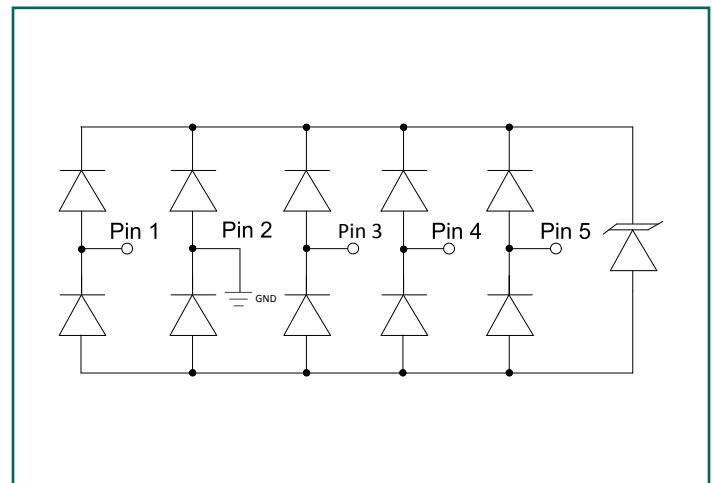

## Absolute Maximum Ratings

Rating	Symbol	Value	Units
Peak Pulse Current (tp = 8/20μs)	I <sub>PP</sub>	4	A
ESD per IEC 61000-4-2 (Contact) <sup>(1)</sup> ESD per IEC 61000-4-2 (Air) <sup>(1)</sup>	V <sub>ESD</sub>	±20 ±25	kV
Operating Temperature	T <sub>J</sub>	-40 to +85	°C
Storage Temperature	T <sub>STG</sub>	-55 to +150	°C

## Electrical Characteristics (T=25°C unless otherwise specified)

Parameter	Symbol	Conditions	Min.	Typ.	Max.	Units
Reverse Stand-Off Voltage	V <sub>RWM</sub>	Any I/O to GND			5	V
Reverse Breakdown Voltage	V <sub>BR</sub>	I <sub>BR</sub> = 1mA, Any I/O to GND	6.5	9.7	11.5	V
Reverse Leakage Current	I <sub>R</sub>	V <sub>RWM</sub> = 5V, Any I/O to GND		5	100	nA
Clamping Voltage	V <sub>C</sub>	I <sub>PP</sub> = 1A, tp = 8/20μs			15	V
		I <sub>PP</sub> = 4A, tp = 8/20μs			25	
ESD Clamping Voltage <sup>2</sup>	V <sub>C</sub>	I = 4A, tp = 0.2/100ns (TLP)		14		V
ESD Clamping Voltage <sup>2</sup>	V <sub>C</sub>	I = 16A, tp = 0.2/100ns (TLP)		24		V
Dynamic Resistance <sup>2,3</sup>	R <sub>DYN</sub>	tp = 0.2/100ns (TLP)		1.0		Ohms
Junction Capacitance	C <sub>J</sub>	V <sub>R</sub> = 0V, f = 1MHz		0.19	0.22	pF

### Notes:

(1) ESD gun return path connected to Ground Reference Plane (GRP)

(2) Transmission Line Pulse Test (TLP) Settings: tp = 100ns, tr = 0.2ns, I<sub>TLP</sub> and V<sub>TLP</sub> averaging window: t<sub>1</sub> = 70ns to t<sub>2</sub> = 90ns.

(3) Dynamic resistance calculated from I<sub>TLP</sub> = 4A to I<sub>TLP</sub> = 16A

# Typical Characteristics

**Clamping Voltage vs. Peak Pulse Current**

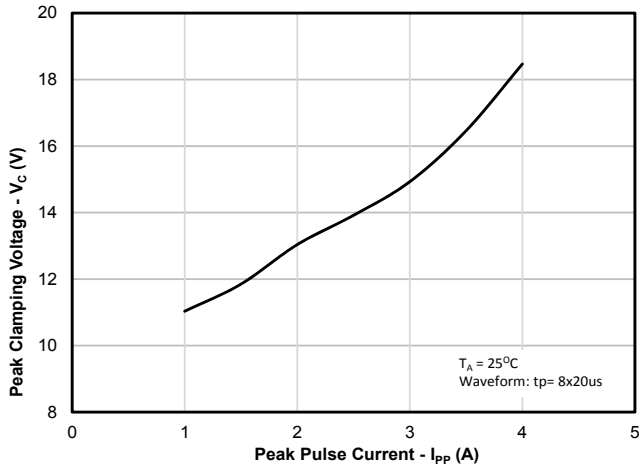

**Junction Capacitance vs. Reverse Voltage**

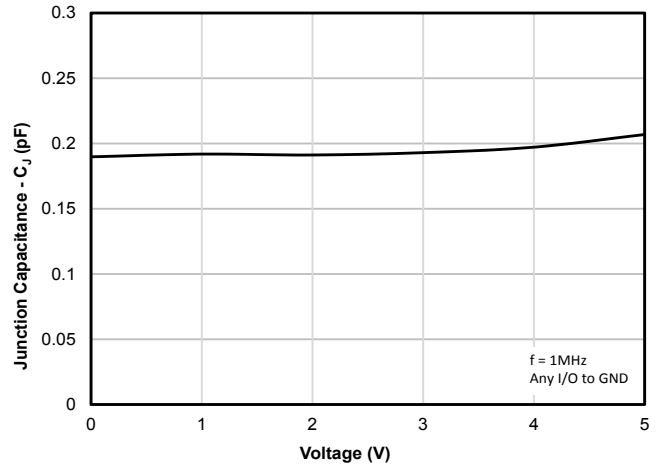

**ESD Clamping Voltage (8kV Contact per IEC61000-4-2)**

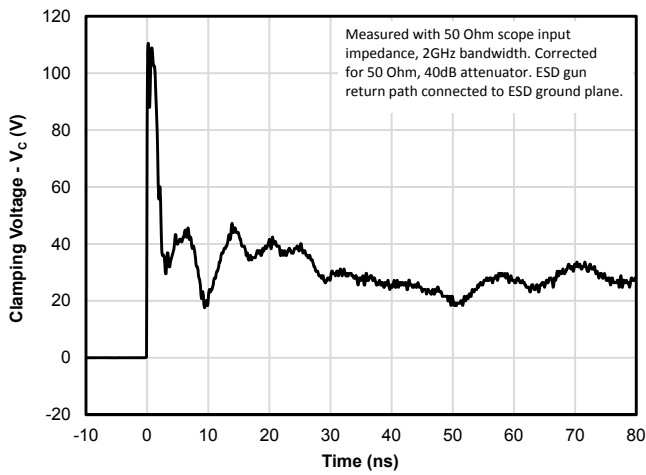

**ESD Clamping Voltage (-8kV Contact per IEC61000-4-2)**

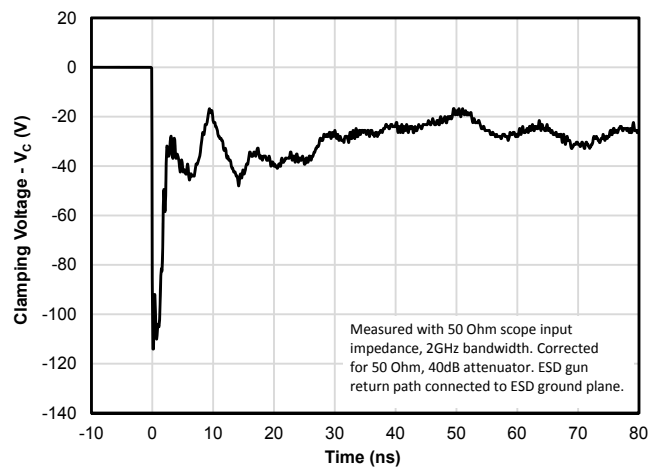

**TLP Characteristic (Positive Pulse)**

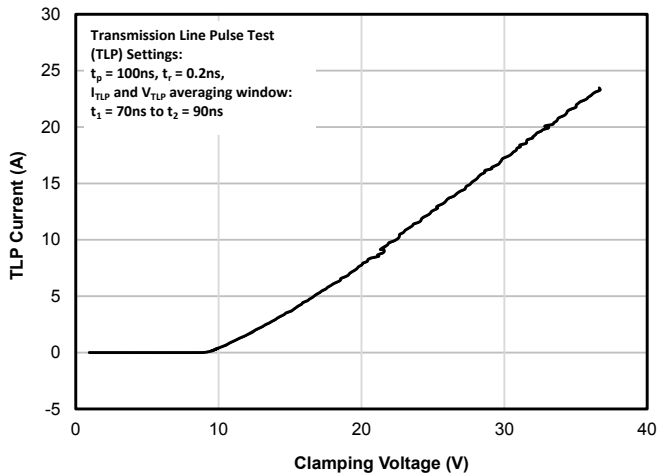

**TLP Characteristic (Negative Pulse)**

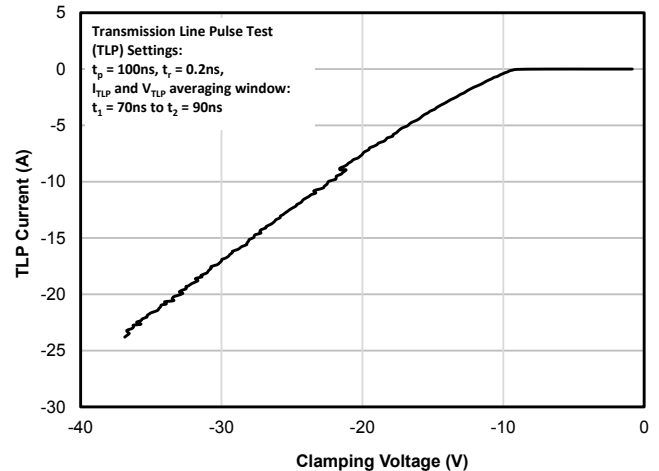

# Typical Characteristics

Insertion Loss (S21)

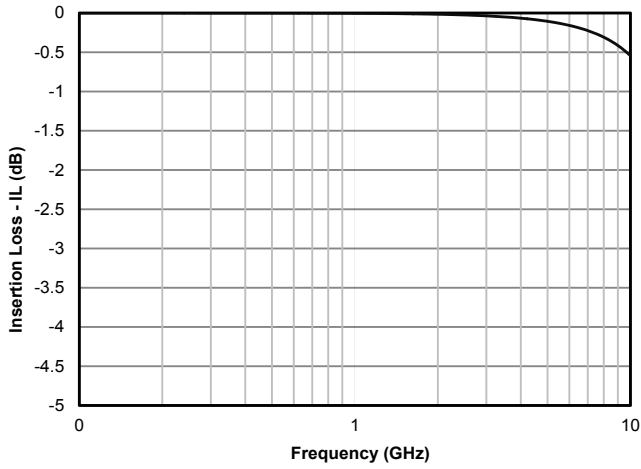

Analog Crosstalk

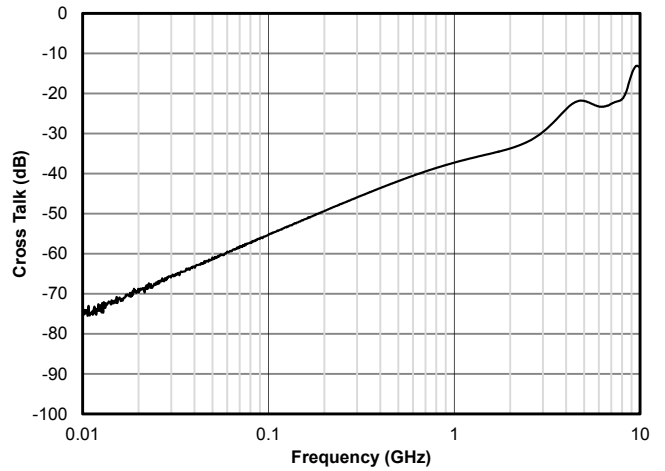

10Gb/s (USB 3.1) Eye Diagram with RClamp7534P

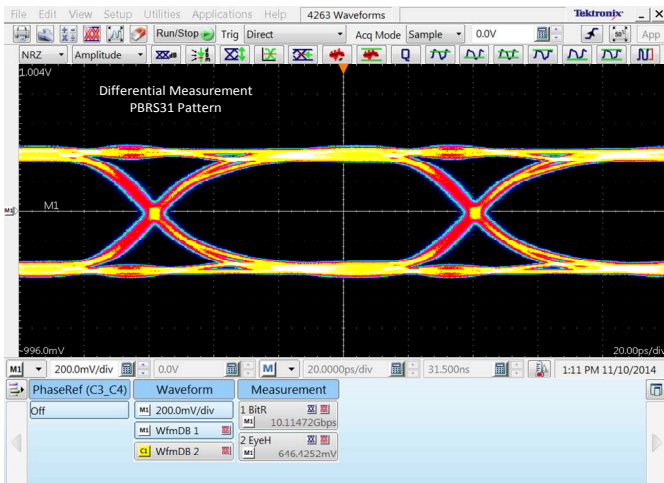

10Gb/s (USB 3.1) Eye Diagram without RClamp7534P

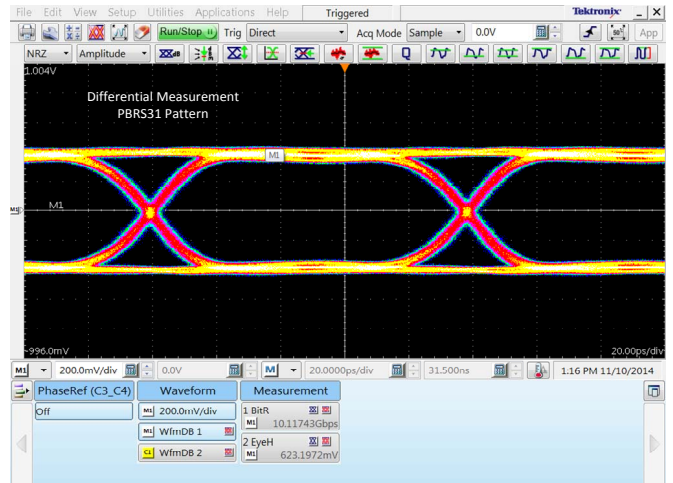

10GbE Eye Diagram with RClamp7534P

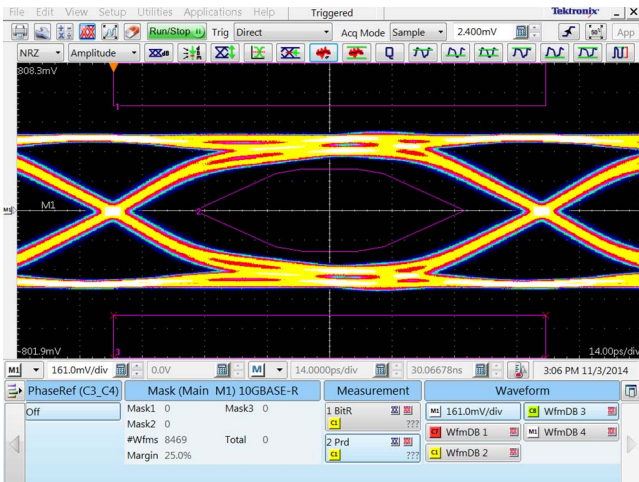

10GbE Eye Diagram without RClamp7534P

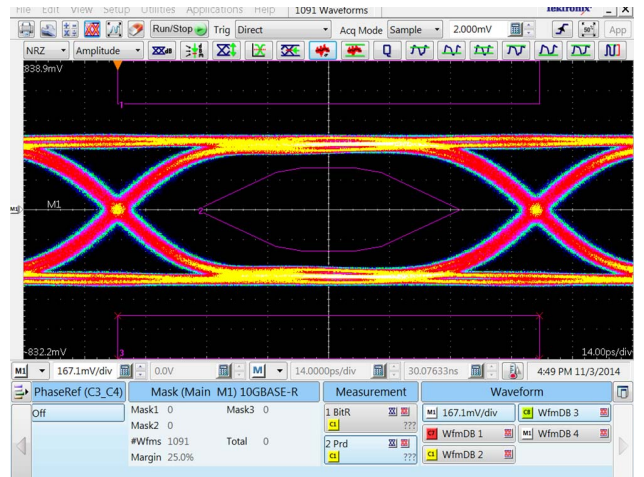

# Applications Information

## Assembly Guidelines

The small size of this device means that some care must be taken during the mounting process to insure reliable solder joints. The figure at the right details Semtech's recommended mounting pattern. Recommended assembly guidelines are shown in Table 1. Note that these are only recommendations and should serve only as a starting point for design since there are many factors that affect the assembly process. Exact manufacturing parameters will require some experimentation to get the desired solder application. Semtech's recommended mounting pattern is based on the following design guidelines:

### Land Pattern

The recommended land pattern follows IPC standards and is designed for maximum solder coverage. Detailed dimensions are shown elsewhere in this document.

### Solder Stencil

Stencil design is one of the key factors which will determine the volume of solder paste which is deposited onto the land pad. The area ratio of the stencil aperture will determine how well the stencil will print. The area ratio takes into account the aperture shape, aperture size, and stencil thickness. An area ratio of 0.70 – 0.75 is preferred for the subject package. The area ratio of a rectangular aperture is given as:

$$\text{Area Ratio} = (L * W) / (2 * (L + W) * T)$$

Where:

L = Aperture Length

W = Aperture Width

T = Stencil Thickness

Semtech recommends a stencil thickness of 0.100mm for this device. The stencil should be laser cut with electro-polished finish. The stencil should have a positive taper of approximately 5 degrees. Electro polishing and tapering the walls results in reduced surface friction and better paste release. For small pitch components, Semtech recommends a square aperture with rounded corners for consistent solder release. Due to the small aperture size, a solder paste with Type 4 or smaller particles are recommended.

## Recommended Mounting Pattern

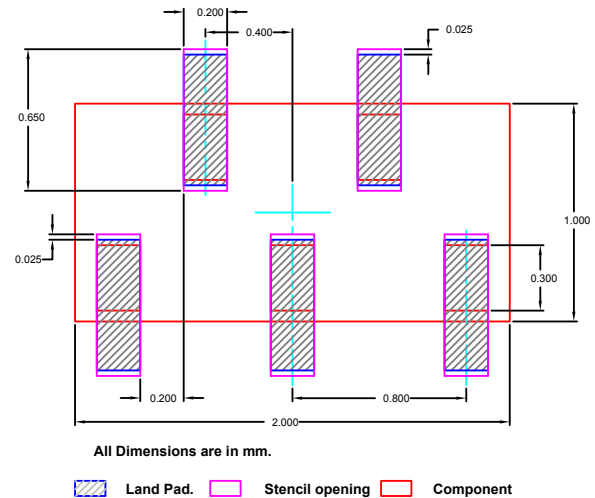

Assembly Parameter	Recommendation
Solder Stencil Design	Laser Cut, Electro-Polished
Aperture Shape	Rectangular with rounded corners
Solder Stencil Thickness	0.100mm (0.004")
Solder Paste Type	Type 4 size sphere or smaller
Solder Reflow Profile	Per JEDEC J-STD-020
PCB Solder pad Design	Non-Solder Mask Defined
PCB Pad Finish	OSP or NiAu

# Outline Drawing - SGP2010N5

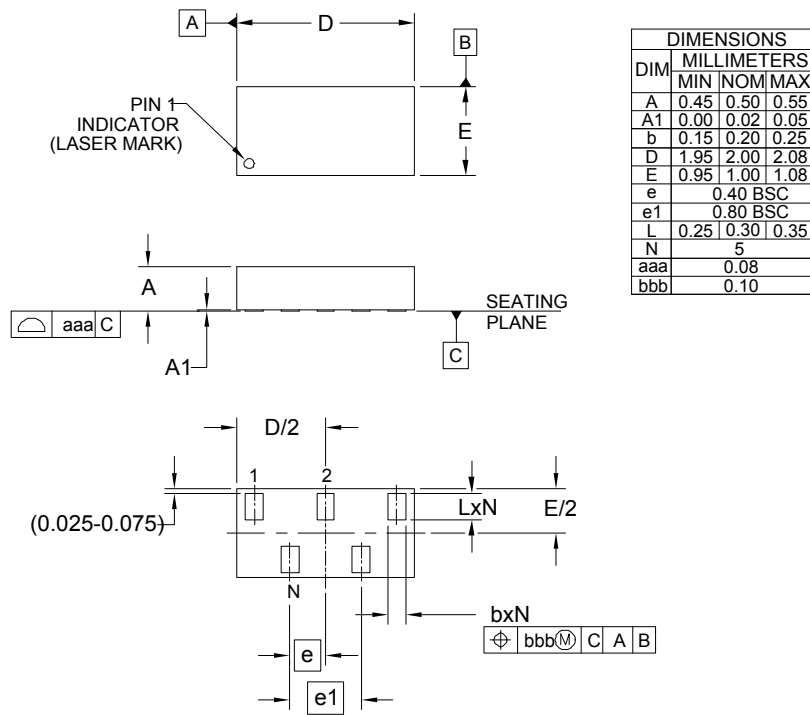

NOTES:  
 1. CONTROLLING DIMENSIONS ARE IN MILLIMETERS (ANGLES IN DEGREES). Package Number-4-R0

# Land Pattern - SGP2010N5

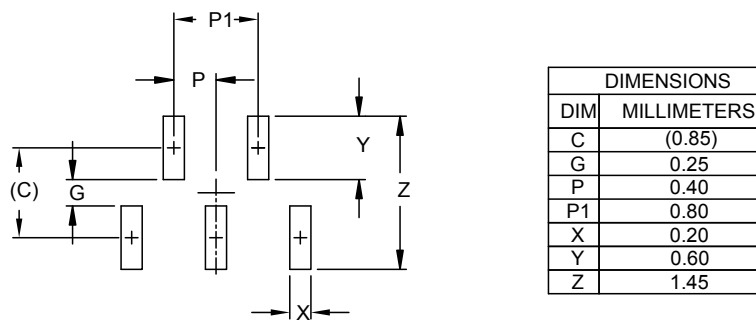

NOTES:  
 1. CONTROLLING DIMENSIONS ARE IN MILLIMETERS (ANGLES IN DEGREES).  
 2. THIS LAND PATTERN IS FOR REFERENCE PURPOSES ONLY.  
 CONSULT YOUR MANUFACTURING GROUP TO ENSURE YOUR COMPANY'S MANUFACTURING GUIDELINES ARE MET.

## Marking Code

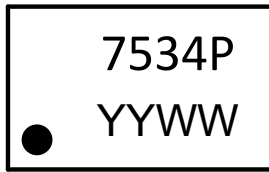

Notes: YYWW = Alphanumeric Date Code

## Tape and Reel Specification

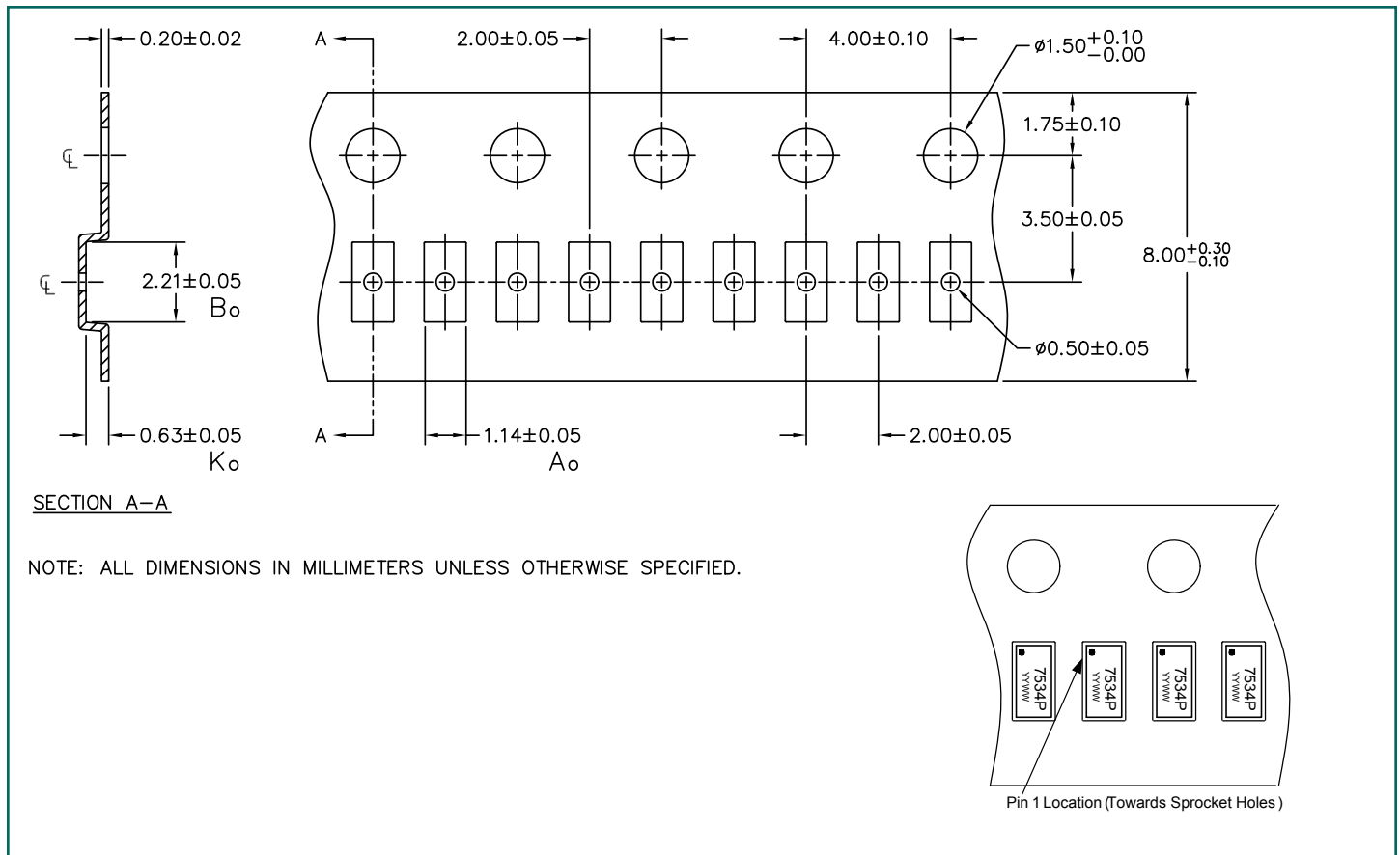

## Ordering Information

Part Number	Qty per Reel	Reel Size
RClamp7534P.TNT	10000	7 Inch

RailClamp and RClamp are registered trademarks of Semtech Corporation.



---

#### IMPORTANT NOTICE

Information relating to this product and the application or design described herein is believed to be reliable, however such information is provided as a guide only and Semtech assumes no liability for any errors in this document, or for the application or design described herein. Semtech reserves the right to make changes to the product or this document at any time without notice. Buyers should obtain the latest relevant information before placing orders and should verify that such information is current and complete. Semtech warrants performance of its products to the specifications applicable at the time of sale, and all sales are made in accordance with Semtech's standard terms and conditions of sale.

SEMTECH PRODUCTS ARE NOT DESIGNED, INTENDED, AUTHORIZED OR WARRANTED TO BE SUITABLE FOR USE IN LIFE-SUPPORT APPLICATIONS, DEVICES OR SYSTEMS, OR IN NUCLEAR APPLICATIONS IN WHICH THE FAILURE COULD BE REASONABLY EXPECTED TO RESULT IN PERSONAL INJURY, LOSS OF LIFE OR SEVERE PROPERTY OR ENVIRONMENTAL DAMAGE. INCLUSION OF SEMTECH PRODUCTS IN SUCH APPLICATIONS IS UNDERSTOOD TO BE UNDERTAKEN SOLELY AT THE CUSTOMER'S OWN RISK. Should a customer purchase or use Semtech products for any such unauthorized application, the customer shall indemnify and hold Semtech and its officers, employees, subsidiaries, affiliates, and distributors harmless against all claims, costs damages and attorney fees which could arise.

The Semtech name and logo are registered trademarks of the Semtech Corporation. All other trademarks and trade names mentioned may be marks and names of Semtech or their respective companies. Semtech reserves the right to make changes to, or discontinue any products described in this document without further notice. Semtech makes no warranty, representation or guarantee, express or implied, regarding the suitability of its products for any particular purpose. All rights reserved.

© Semtech 2015

---

#### Contact Information

Semtech Corporation  
200 Flynn Road, Camarillo, CA 93012  
Phone: (805) 498-2111, Fax: (805) 498-3804  
[www.semtech.com](http://www.semtech.com)



## X-ON Electronics

Largest Supplier of Electrical and Electronic Components

*Click to view similar products for [ESD Suppressors / TVS Diodes](#) category:*

*Click to view products by [Semtech](#) manufacturer:*

Other Similar products are found below :

[60KS200C](#) [D12V0H1U2WS-7](#) [D18V0L1B2LP-7B](#) [82356050220](#) [D5V0M5U6V-7](#) [NTE4902](#) [P4KE27CA](#) [P6KE11CA](#) [P6KE39CA-TP](#)  
[P6KE8.2A](#) [SA110CA](#) [SA60CA](#) [SA64CA](#) [SMBJ12CATR](#) [SMBJ8.0A](#) [SMLJ30CA-TP](#) [ESD101-B1-02ELS E6327](#) [ESD112-B1-02EL E6327](#)  
[ESD119B1W01005E6327XTSA1](#) [ESD5V0L1B02VH6327XTSA1](#) [ESD7451N2T5G](#) [19180-510](#) [CPDT-5V0USP-HF](#) [3.0SMCJ33CA-F](#)  
[3.0SMCJ36A-F](#) [HSPC16701B02TP](#) [D3V3Q1B2DLP3-7](#) [D55V0M1B2WS-7](#) [DESD5V0U1BL-7B](#) [DRTR5V0U4SL-7](#) [SCM1293A-04SO](#)  
[ESD200-B1-CSP0201 E6327](#) [ESD203-B1-02EL E6327](#) [SM12-7](#) [SMF8.0A-TP](#) [SMLJ45CA-TP](#) [CEN955 W/DATA](#) [82350120560](#)  
[82356240030](#) [VESD12A1A-HD1-GS08](#) [CPDUR5V0R-HF](#) [CPDUR24V-HF](#) [CPDQC5V0U-HF](#) [CPDQC5V0USP-HF](#) [CPDQC5V0-HF](#)  
[D1213A-01LP4-7B](#) [D1213A-02WL-7](#) [ESDLIN1524BJ-HQ](#) [5KP100A](#) [5KP15A](#)