

### POWER MANAGEMENT

#### Description

The SC4211H is a high performance positive voltage regulator designed for use in applications requiring very low Input voltage and very low dropout voltage at up to 1 amperes. It operates with a  $V_{in}$  as low as 1.4V, with output voltage programmable as low as 0.5V. The SC4211H features ultra low dropout, ideal for applications where  $V_{out}$  is very close to  $V_{in}$ . Additionally, the SC4211H has an enable pin to further reduce power dissipation while shutdown. The SC4211H provides excellent regulation over variations in line, load and temperature.

The SC4211H is available in the SOIC-8-EDP (Exposed Die Pad) package. Depending on how the FB pin is configured, the output voltage can be either externally adjusted or fixed to 0.5V.

#### Features

- ◆ Input Voltage as low as 1.4V
- ◆ 400mV dropout @ 1A
- ◆ Adjustable output from 0.5V
- ◆ Over current and over temperature protection
- ◆ Enable pin
- ◆ 10 $\mu$ A quiescent current in shutdown
- ◆ Full industrial temperature range
- ◆ Available in SOIC-8-EDP Lead-free package, fully WEEE and RoHS compliant

#### Applications

- ◆ Telecom/Networking cards
- ◆ Motherboards/Peripheral cards
- ◆ Industrial Applications
- ◆ Wireless infrastructure
- ◆ Set top boxes
- ◆ Medical equipment
- ◆ Notebook computers
- ◆ Battery powered systems

#### Typical Application Circuits

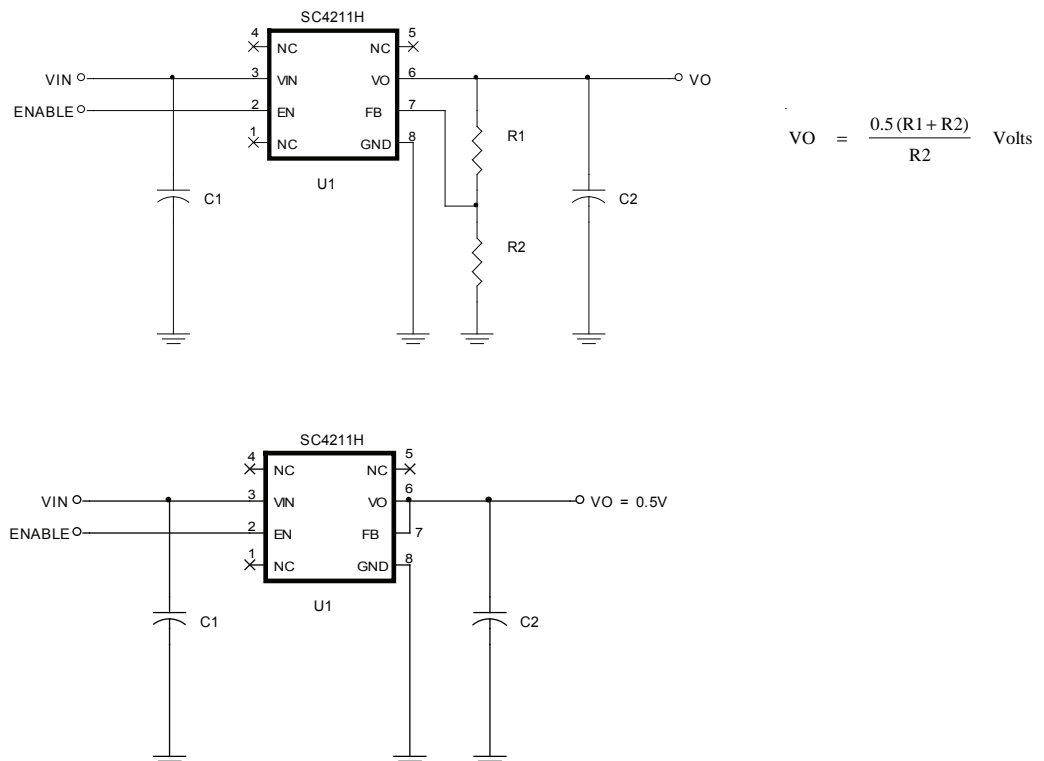

**POWER MANAGEMENT**
**Absolute Maximum Ratings**

Exceeding the specifications below may result in permanent damage to the device, or device malfunction. Operation outside of the parameters specified in the Electrical Characteristics section is not implied.

Parameter	Symbol	Max	Units
V <sub>in</sub> , EN, V <sub>o</sub> , FB to GND		7	V
Power Dissipation	P <sub>D</sub>	Internally Limited	W
Thermal Resistance Junction to Ambient <sup>(1)</sup>	θ <sub>JA</sub>	36	°C/W
Thermal Resistance Junction to Case <sup>(1)</sup>	θ <sub>JC</sub>	5.5	°C/W
Operating Ambient Temperature Range	T <sub>A</sub>	-40 to +85	°C
Operating Junction Temperature Range	T <sub>J</sub>	-40 to +125	°C
Storage Temperature Range	T <sub>STG</sub>	-65 to +150	°C
Peak IR Reflow Temperature (10s to 30s)	T <sub>P</sub>	260	°C
ESD Rating (Human Body Model) <sup>(2)</sup>	V <sub>ESD</sub>	2	kV

Notes:

(1) Calculated from package in still air, mounted to 3" x 4.5", 4 layer FR4 PCB with thermal vias under the exposed pad per JESD51 standards,

(2) Tested according to JEDEC standard JESD22-A114-B.

**Electrical Characteristics**

Unless specified: V<sub>EN</sub> = V<sub>IN</sub>; V<sub>FB</sub> = V<sub>O</sub>; V<sub>IN</sub> = 1.40V to 6.0V; I<sub>O</sub> = 8mA to 1A.  
Values in **bold** apply over the full operating temperature range.

Parameter	Symbol	Test Conditions	Min	Typ	Max	Units
<b>VIN</b>						
Supply Voltage Range	V <sub>IN</sub>		<b>1.40</b>		<b>6.0</b>	V
Quiescent Current	I <sub>Q</sub>	V <sub>IN</sub> = 3.3V, I <sub>O</sub> = 0A			<b>3</b>	mA
		V <sub>IN</sub> = 6.0V, V <sub>EN</sub> = 0V		10	<b>50</b>	μA
<b>VO</b>						
Line Regulation <sup>(1)</sup>	REG <sub>(LINE)</sub>	I <sub>O</sub> = 10mA		0.2	<b>0.4</b>	%/V
Load Regulation <sup>(1)</sup>	REG <sub>(LOAD)</sub>	I <sub>O</sub> = 10mA to 1A		0.5	<b>1.5</b>	%
Dropout Voltage <sup>(1)(2)</sup>	V <sub>DO</sub>	I <sub>O</sub> = 500mA		100	250	mV
					<b>300</b>	

**POWER MANAGEMENT**
**Electrical Characteristics (Cont.)**

Unless specified:  $V_{EN} = V_{IN}$ ,  $V_{FB} = V_O$ ,  $V_{IN} = 1.40V$  to  $6.0V$ ,  $I_O = 8mA$  to  $1A$ .  
 Values in **bold** apply over the full operating temperature range.

Parameter	Symbol	Test Conditions	Min	Typ	Max	Units
<b>VO (Cont.)</b>						
Dropout Voltage <sup>(1)(2)</sup>	$V_{DO}$	$I_O = 1A$		200	400	mV
					<b>500</b>	
Minimum Load Current <sup>(3)</sup>	$I_O$	$V_{IN} = V_O + 0.5V$			<b>8</b>	mA
Current Limit <sup>(4)</sup>	$I_{CL}$		<b>1.1</b>	1.5	<b>2.0</b>	A
<b>Feedback</b>						
Reference Voltage <sup>(1)</sup>	$V_{REF}$	$V_{IN} = 3.3V$ , $V_{FB} = V_{OUT}$ , $I_O = 10mA$	0.495	0.5	0.505	V
		Full $I_{OUT}$ , and $V_{IN}$ Range	<b>0.490</b>		<b>0.510</b>	
Feedback Pin Current <sup>(4)</sup>	$I_{ADJ}$	$V_{FB} = V_{REF}$		80	<b>200</b>	nA
<b>EN</b>						
Enable Pin Current	$I_{EN}$	$V_{EN} = 0V$ , $V_{IN} = 3.3V$		1.5	<b>10</b>	$\mu A$
Enable Pin Threshold	$V_{IH}$	$V_{IN} = 3.3V$	<b>1.6</b>			V
	$V_{IL}$	$V_{IN} = 3.3V$			<b>0.4</b>	
<b>Over Temperature Protection</b>						
High Trip level	$T_{HI}$			160		$^{\circ}C$
Hysteresis	$T_{HYST}$			10		$^{\circ}C$

**Notes:**

- (1) Low duty cycle pulse testing with Kelvin connections required.
- (2)  $V_{DO} = V_{IN} - V_O$  when  $V_O$  decreases by 1.5% of its nominal output voltage with  $V_{IN} = V_O + 0.8V$ .
- (3) Required to maintain regulation. Voltage set resistors R1 and R2 are usually utilized to meet this requirement.
- (4) Guaranteed by design.

**Ordering Information**

Part Number	Package	Temp. Range (T <sub>j</sub> )
SC4211HSTRT <sup>(1)(2)</sup>	SOIC-8-EDP	-40 to +125 °C
SC4211HEVB	Evaluation Board	

**Notes:**

(1) Only available in tape and reel packaging. A reel contains 2500 devices.

(2) Lead-free product. This product is fully WEEE and RoHS compliant.

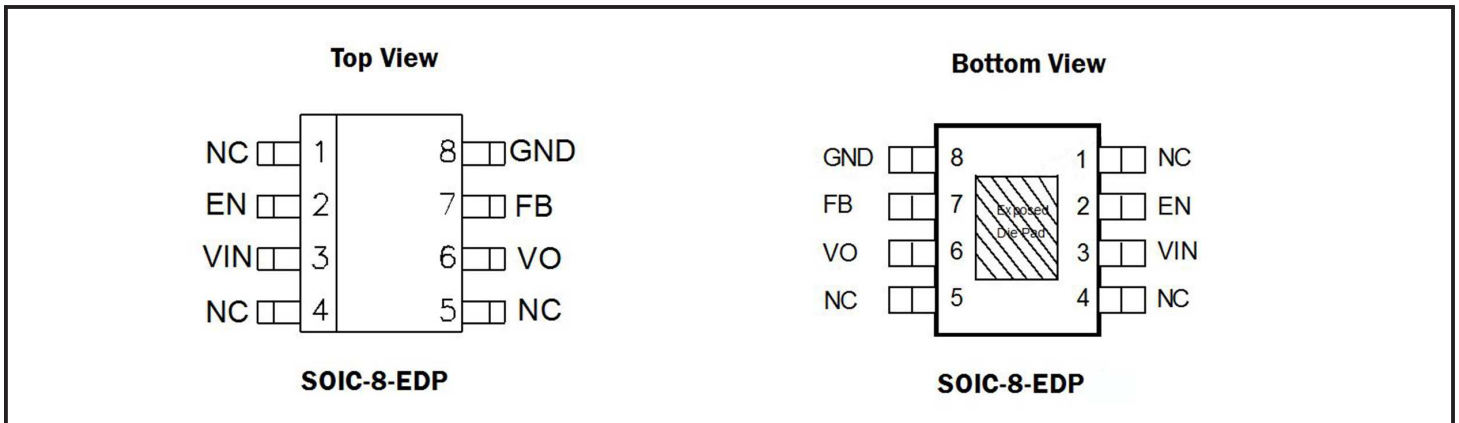
**Pin Configuration**

**Pin Descriptions**

Pin #	Pin Name	Pin Description
2	EN	Enable Input. Pulling this pin below 0.4V turns the regulator off, reducing the quiescent current to a fraction of its operating value. The device will be enabled if this pin is left open. Connect to VIN if not being used.
3	VIN	Input voltage. For regulation at full load, the input to this pin must be between (VO + 0.5V) and 5.5V. Minimum VIN=1.4V. A large bulk capacitance should be placed closely to this pin to ensure that the input supply does not sag below 1.4V. Also a minimum of 4.7uF ceramic capacitor should be placed directly at this pin.
6	VO	The pin is the power output of the device. A minimum of 10uF capacitor should be placed directly at this pin.
7	FB	Output voltage feedback pin. If connected to the VO pin, the output voltage will be set at 0.5V. If external feedback resistors are used, the output voltage will be (See Application Circuits on page 1): $VO = [0.5 (R1+R2)] / R2 \text{ Volts}$
8	GND	Reference ground. The GND pin and the exposed die pad must be connected together at the IC pin.
1, 4, 5	NC	No connection.
	THERMAL PAD	Pad for heatsinking purposes. Connect to ground plane using multiple vias. Not electrically connected internally.

**POWER MANAGEMENT**

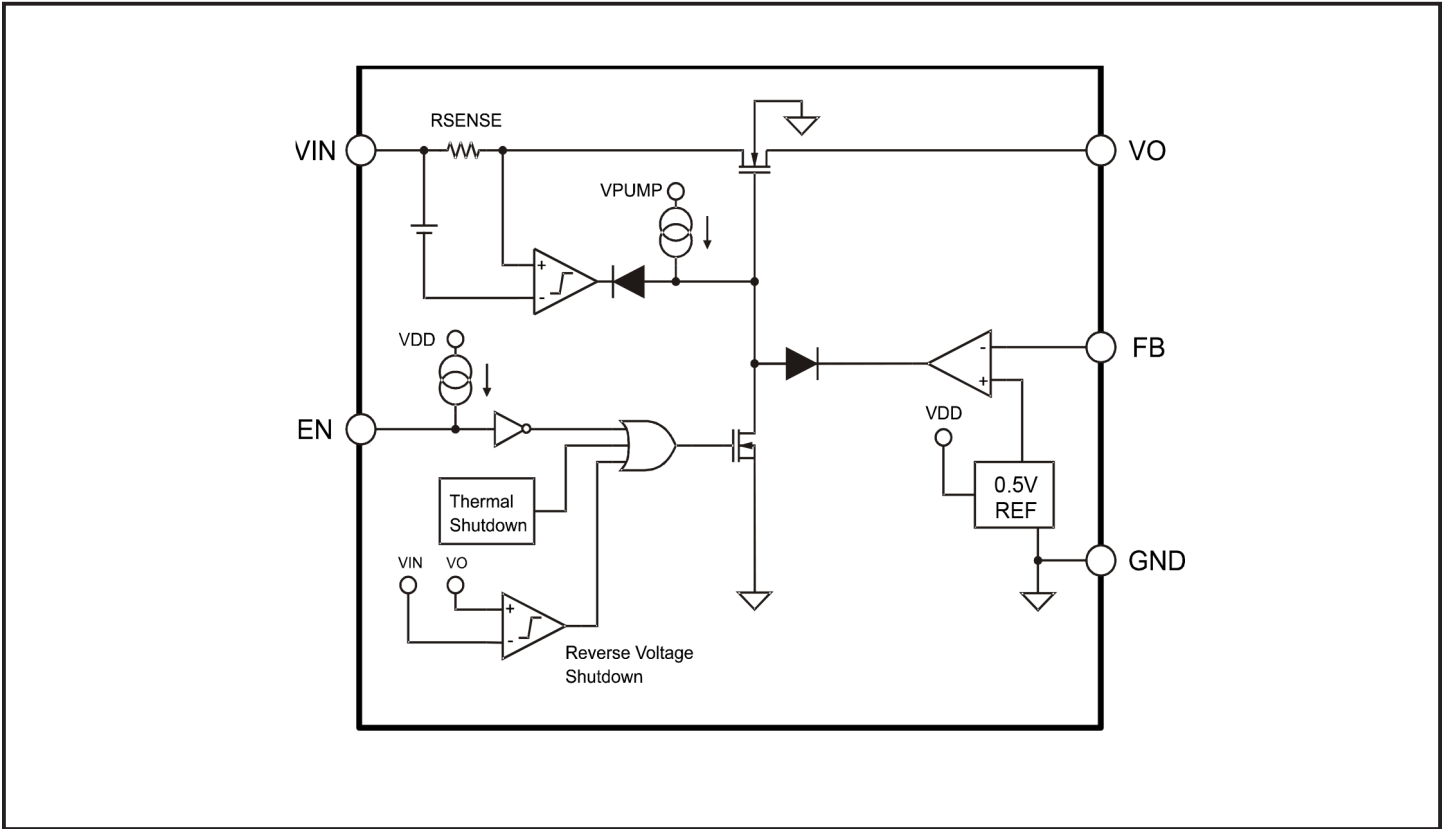
**Block Diagram**



**Marking Information**

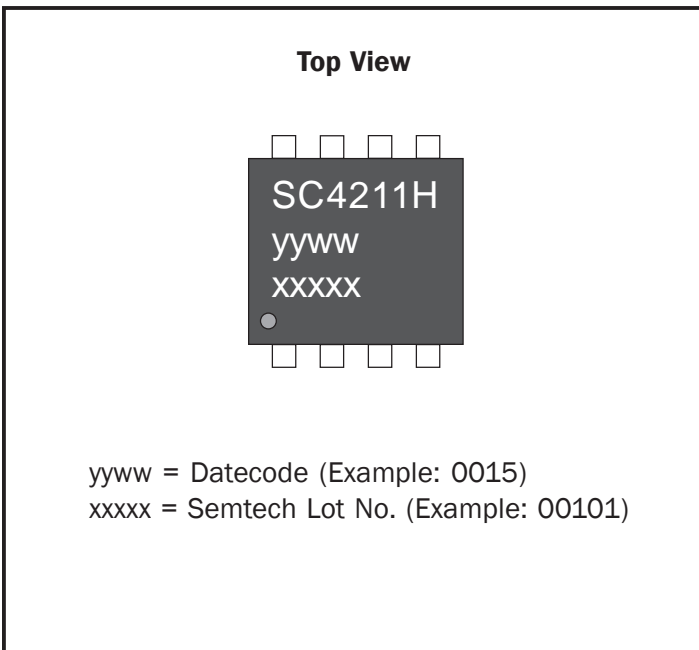

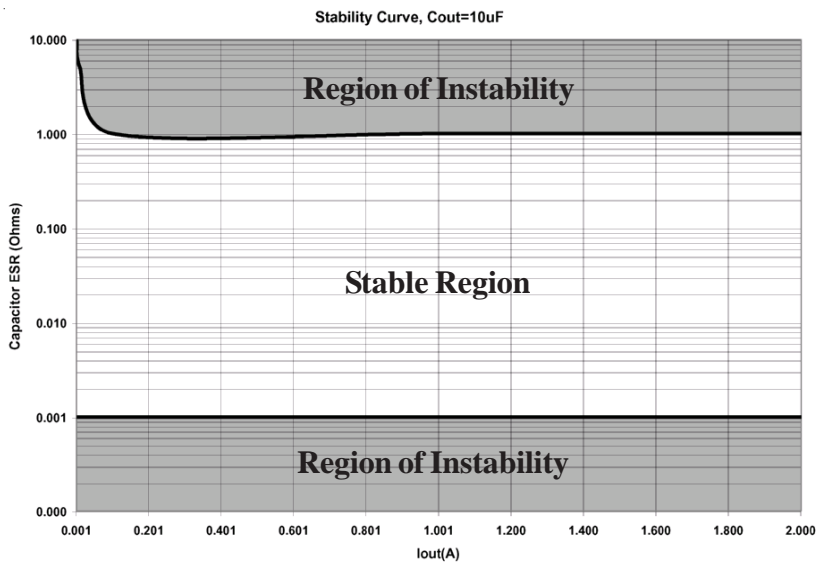
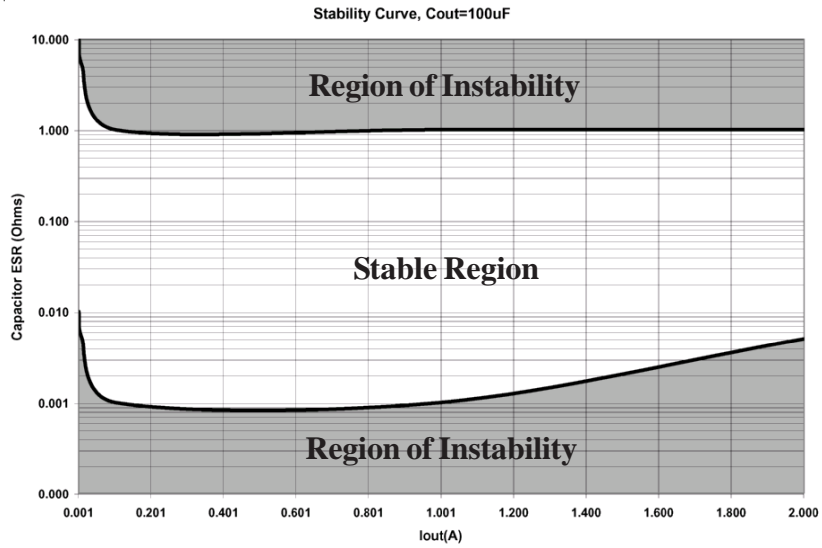

**POWER MANAGEMENT**
**Applications Information**
**Introduction**

The SC4211H is intended for applications where high current capability and very low dropout voltage are required. It provides a very simple, low cost solution that uses very little PCB real estate. Additional features include an enable pin to allow for a very low power consumption standby mode, and a fully adjustable output.

**Component Selection**

**Input capacitor:** A large bulk capacitance of about  $\geq 10\mu\text{F}/\text{A}$  (output load) should be closely placed to the input supply pin of the SC4211H to ensure that  $V_{\text{IN}}$  does not sag below 1.4V. Also a minimum of 4.7 $\mu\text{F}$  ceramic capacitor is recommended to be placed directly next to the  $V_{\text{IN}}$  pin. This allows for the device being some distance from any bulk capacitance on the rail. Additionally, input droop due to load transients is reduced, improving load transient response. Additional capacitance may be added if required by the application.

**Output capacitor:** A minimum bulk capacitance of  $\geq 10\mu\text{F}/\text{A}$  (output load), along with a 0.1 $\mu\text{F}$  ceramic decoupling capacitor is recommended. Increasing the bulk capacitance will improve the overall transient response. The use of multiple lower value ceramic capacitors in parallel to achieve the desired bulk capacitance will not cause stability issues. Although designed for use with ceramic output capacitors, the SC4211H is extremely tolerant of output capacitor ESR values and thus will also work comfortably with tantalum output capacitors.

**Noise immunity:** In very electrically noisy environments, it is recommended that 0.1 $\mu\text{F}$  ceramic capacitors be placed from IN to GND and OUT to GND as close to the device pins as possible.

**Internal voltage selection:** By connecting the FB pin directly to the VO pin, the output voltage will be regulated to the 0.5V internal reference.

**External voltage selection resistors:** The use of 1% resistors, and designing for a current flow  $\geq 8\text{mA}$  is recommended to ensure a well regulated output (thus  $R_2 \leq 62.5\Omega$ ).

**Enable:** Pulling this pin below 0.4V turns the regulator off, reducing the quiescent current to a fraction of its

operating value. A pull up resistor up to 400kOhms should be connected from this pin to the  $V_{\text{IN}}$  pin in application where supply voltages of  $V_{\text{IN}} < 1.9\text{V}$  is required. For applications with higher voltages than 1.9V, EN pin could be left open or connected to  $V_{\text{IN}}$ .

**Thermal Considerations**

The power dissipation in the SC4211H is approximately equal to the product of the output current and the input to output voltage differential:

$$P_D \approx (V_{\text{IN}} - V_{\text{OUT}}) \cdot I_O$$

The absolute worst-case dissipation is given by:

$$P_{D(\text{MAX})} = (V_{\text{IN}(\text{MAX})} - V_{\text{OUT}(\text{MIN})}) \cdot I_{O(\text{MAX})} + V_{\text{IN}(\text{MAX})} \cdot I_{Q(\text{MAX})}$$

For a typical scenario,  $V_{\text{IN}} = 3.3\text{V} \pm 5\%$ ,  $V_{\text{OUT}} = 2.8\text{V}$  and  $I_O = 1\text{A}$ , therefore:

$$V_{\text{IN}(\text{MAX})} = 3.465\text{V}, V_{\text{OUT}(\text{MIN})} = 2.744\text{V} \text{ and } I_{Q(\text{MAX})} = 1.75\text{mA},$$

$$\text{Thus } P_{D(\text{MAX})} = .722\text{W}.$$

Using this figure, and assuming  $T_{A(\text{MAX})} = 70^\circ\text{C}$ , we can calculate the maximum thermal impedance allowable to maintain  $T_J \leq 150^\circ\text{C}$ :

$$R_{\text{TH}(J-A)(\text{MAX})} = \frac{(T_{J(\text{MAX})} - T_{A(\text{MAX})})}{P_{D(\text{MAX})}} = \frac{(150 - 70)}{.722} = 110^\circ\text{C}/\text{W}$$

This should be achievable for the SOIC-8-EDP package using PCB copper area to aid in conducting the heat away, such as one square inch of copper connected to the ground pins of the device. Internal ground/power planes and air flow will also assist in removing heat. For higher ambient temperatures it may be necessary to use additional copper area.

POWER MANAGEMENT

Outline Drawing - SOIC-8-EDP

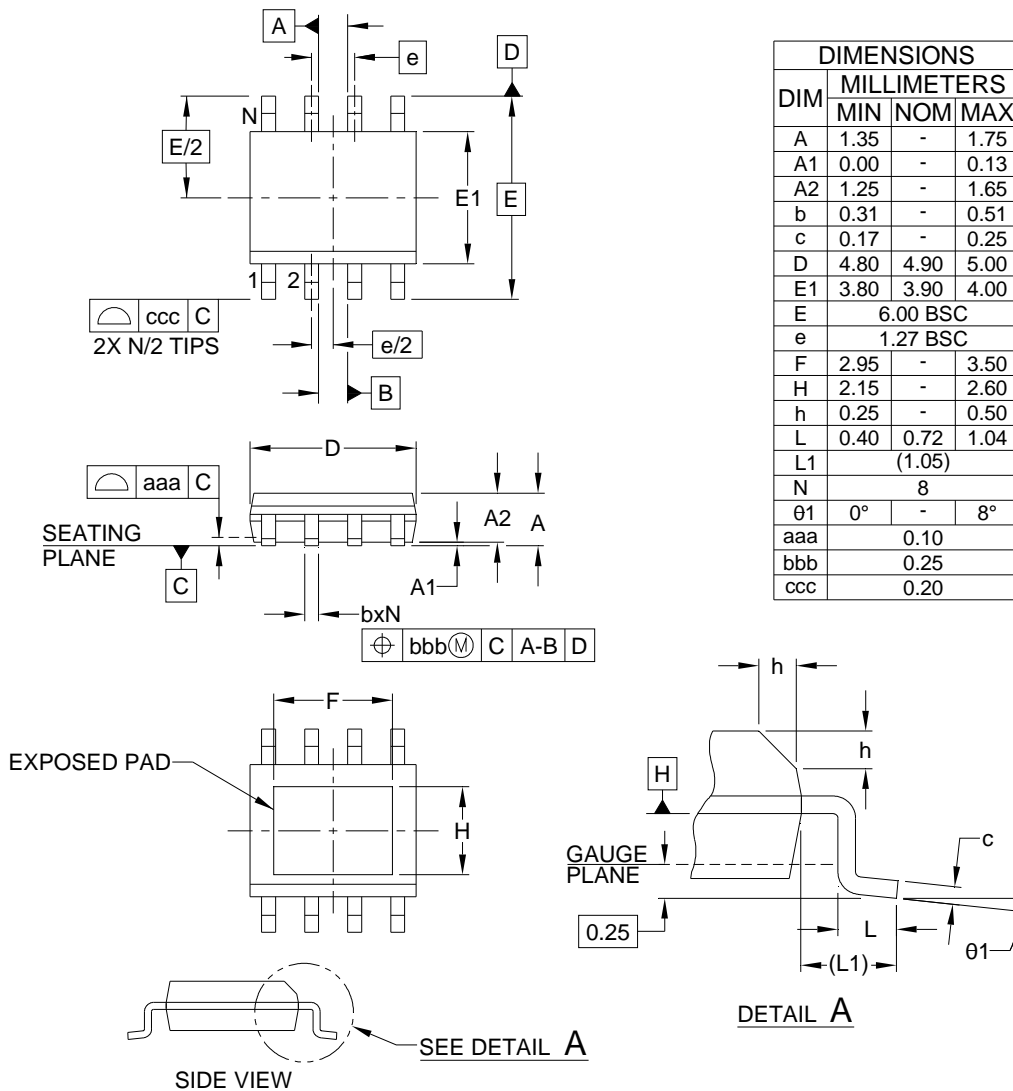

NOTES:

1. CONTROLLING DIMENSIONS ARE IN MILLIMETERS (ANGLES IN DEGREES).
2. DATUMS **-A-** AND **-B-** TO BE DETERMINED AT DATUM PLANE **-H-**.
3. DIMENSIONS "E1" AND "D" DO NOT INCLUDE MOLD FLASH, PROTRUSIONS OR GATE BURRS.
4. THE MEASUREMENT OF DIMENSION "F" DOES NOT INCLUDE EXPOSED TIE BAR.



**POWER MANAGEMENT**

**Land Pattern - SOIC-8-EDP**

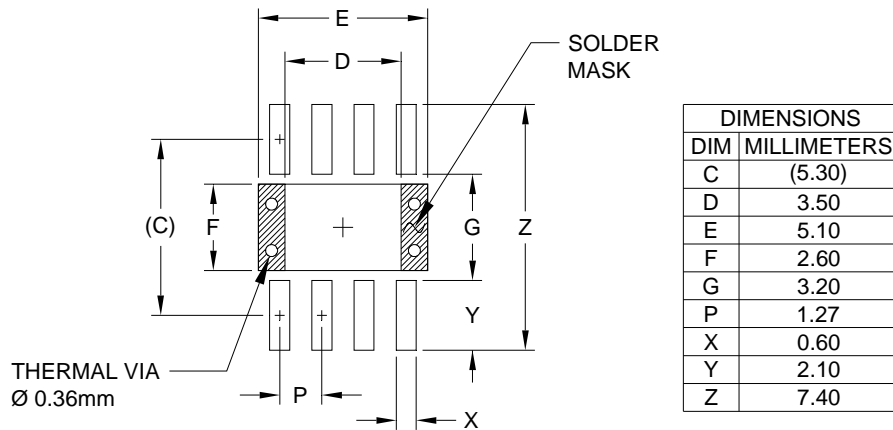

NOTES:

1. CONTROLLING DIMENSIONS ARE IN MILLIMETERS (ANGLES IN DEGREES).
2. THIS LAND PATTERN IS FOR REFERENCE PURPOSE ONLY. CONSULT YOUR MANUFACTURING GROUP TO ENSURE YOUR COMPANY'S MANUFACTURING GUIDELINES ARE MET.
3. THERMAL VIAS IN THE LAND PATTERN OF THE EXPOSED PAD SHALL BE CONNECTED TO A SYSTEM GROUND PLANE. FAILURE TO DO SO MAY COMPROMISE THE THERMAL AND/OR FUNCTIONAL PERFORMANCE OF THE DEVICE.
4. REFERENCE IPC-SM-782A, SECTION 9.1, RLP NO. 300A.

**Contact Information**

Semtech Corporation  
 Power Management Products Division  
 200 Flynn Road, Camarillo, CA 93012  
 Phone: (805)498-2111 FAX (805)498-3804

## X-ON Electronics

Largest Supplier of Electrical and Electronic Components

*Click to view similar products for [LDO Voltage Regulators](#) category:*

*Click to view products by [Semtech](#) manufacturer:*

Other Similar products are found below :

[L79M05TL-E](#) [PT7M8202B12TA5EX](#) [TCR3DF185,LM\(CT](#) [TCR3DF24,LM\(CT](#) [TCR3DF285,LM\(CT](#) [TCR3DF31,LM\(CT](#)  
[TCR3DF45,LM\(CT](#) [MP2013GQ-33-Z](#) [059985X](#) [NCP4687DH15T1G](#) [701326R](#) [TCR2EN28,LF\(S](#) [NCV8170AXV250T2G](#)  
[TCR3DF27,LM\(CT](#) [TCR3DF19,LM\(CT](#) [TCR3DF125,LM\(CT](#) [TCR2EN18,LF\(S](#) [AP2112R5A-3.3TRG1](#) [AP7315-25W5-7](#)  
[IFX30081LDVGRNXUMA1](#) [NCV47411PAAJR2G](#) [AP2113KTR-G1](#) [AP2111H-1.2TRG1](#) [ZLDO1117QK50TC](#) [AZ1117IH-1.8TRG1](#)  
[AZ1117ID-ADJTRG1](#) [TCR3DG12,LF](#) [MIC5514-3.3YMT-T5](#) [MIC5512-1.2YMT-T5](#) [MIC5317-2.8YM5-T5](#) [SCD7912BTG](#)  
[NCP154MX180270TAG](#) [SCD33269T-5.0G](#) [NCV8170BMX330TCG](#) [NCV8170AMX120TCG](#) [NCP706ABMX300TAG](#)  
[NCP153MX330180TCG](#) [NCP114BMX075TCG](#) [MC33269T-3.5G](#) [CAT6243-ADJCMT5T](#) [TCR3DG33,LF](#) [AP2127N-1.0TRG1](#)  
[TCR4DG35,LF](#) [LT1117CST-3.3](#) [TAR5S15U\(TE85L,F\)](#) [TAR5S18U\(TE85L,F\)](#) [TCR3UG19A,LF](#) [TCR4DG105,LF](#) [NCV8170AMX360TCG](#)  
[MIC94310-NYMT-T5](#)