

### DESCRIPTION

The SMBJ series of transient voltage suppressors are designed to protect components from over voltages caused by electrostatic discharge (ESD), electrical fast transients (EFT), induced lightning, and system generated transients.

TVS diodes are characterized by their high surge capability, low operating and clamping voltages, and fast response time. This makes them ideal for use as board level protection of sensitive semiconductor components. The SMBJ series is suitable protection for sensitive TTL and MOS ICs such as microprocessors, I/O transceivers, ASICs, transducers, and MOS memory.

### APPLICATIONS:

- General Transient Protection
- Board Level Surface Mount Applications
- Industrial & Commercial Electronics
- Portable electronics
- Networks

### FEATURES:

- 600 watts Peak Pulse Power ( $t_p = 10 \times 1000 \mu s$ )
- Unidirectional or Bidirectional
- Wide voltage range (5V - 170V)
- Low clamping voltages
- Solid state silicon avalanche technology

### MECHANICAL CHARACTERISTICS:

- JEDEC DO-214AA Outline
- Molded epoxy case
- Marking : Device code and logo
- Unidirectional devices marked with polarity band

### SCHEMATIC

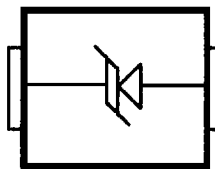

Unidirectional

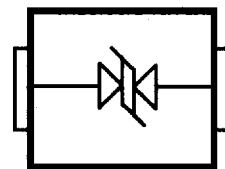

Bidirectional

### MAXIMUM RATINGS

RATING	SYMBOL	VALUE	UNIT
Peak Pulse Power ( $t_p = 10 \times 1000 \mu s$ )	Ppk	600	Watts
Operating Temperature	Tj	-55 to +150	°C
Storage Temperature	Tstg	-55 to +150	°C

### ELECTRICAL CHARACTERISTICS @ 25°C

UNI-DIRECTIONAL PART NUMBER Note 1.	DEVICE MARKING CODE	BI-DIRECTIONAL PART NUMBER Note 1, 2	DEVICE MARKING CODE	REVERSE STAND-OFF VOLTAGE $V_{RWM}$ (V)	REVERSE LEAKAGE $I_{RWM}$ ( $\mu A$ )	BREAKDOWN VOLTAGE $V_{BR}$ MIN @ $I_T$ (V)	TEST CURRENT $I_T$ (mA)	MAXIMUM CLAMPING VOLTAGE @ $I_{PP}$ (Vc) (V)	PEAK PULSE CURRENT ( $I_{PP}$ ) (A)	MAX. VOLTAGE TEMPERATURE VARIATION OF $V_{BR}$ (mV/°C)
SMBJ5.0	KD			5.0	800	6.40	10	9.8	62.6	5.0
SMBJ5.0A	KE			5.0	800	6.40	10	9.2	66.2	5.0
SMBJ5.0	KF	SMBJ5.0C	AF	5.0	800	6.67	10	11.4	62.6	5.0
SMBJ5.0A	KG	SMBJ5.0CA	AG	5.0	800	6.67	10	10.3	58.3	5.0
SMBJ6.5	KH	SMBJ6.5C	AH	6.5	500	7.22	10	12.3	48.7	5.0
SMBJ6.5A	KK	SMBJ6.5CA	AK	6.5	500	7.22	10	11.2	63.6	5.0
SMBJ7.0	KL	SMBJ7.0C	AL	7.0	200	7.78	10	13.3	45.1	6.0
SMBJ7.0A	KM	SMBJ7.0CA	AM	7.0	200	7.78	10	12.0	50.0	6.0
SMBJ7.5	KN	SMBJ7.5C	AN	7.5	100	8.33	1	14.3	42.0	7.0
SMBJ7.5A	KP	SMBJ7.5CA	AP	7.5	100	8.33	1	12.9	46.5	7.0
SMBJ8.0	KQ	SMBJ8.0C	AQ	8.0	50	8.89	1	15.0	40.0	7.0
SMBJ8.0A	KR	SMBJ8.0CA	AR	8.0	50	8.89	1	13.6	44.1	7.0
SMBJ8.5	KS	SMBJ8.5C	AS	8.5	10	9.44	1	15.9	37.7	8.0
SMBJ8.5A	KT	SMBJ8.5CA	AT	8.5	10	9.44	1	14.4	41.7	8.0
SMBJ9.0	KU	SMBJ9.0C	AU	9.0	5	10.0	1	16.8	35.5	9.0
SMBJ9.0A	KV	SMBJ9.0CA	AV	9.0	5	10.0	1	15.4	39.0	9.0

#### ELECTRICAL CHARACTERISTICS @ 25°C (CONTINUED)

UN- DIRECTIONAL PART NUMBER	DEVICE MARKING CODE	BI- DIRECTIONAL PART NUMBER	DEVICE MARKING CODE	REVERSE STAND-OFF VOLTAGE V <sub>RRM</sub>	REVERSE LEAKAGE I <sub>RRM</sub> ( $\mu$ A)	BREAKDOWN VOLTAGE V <sub>BR</sub> MIN @ I <sub>T</sub>	TEST CURRENT I <sub>T</sub> (mA)	MAXIMUM CLAMPING VOLTAGE @ I <sub>pp</sub> (V <sub>o</sub> )	PEAK PULSE CURRENT ( $\mu$ p)	MAX. VOLTAGE TEMPERATURE VARIATION OF V <sub>BR</sub> (mV/°C)
Note 1:		Note 1, 2		(V)	( $\mu$ A)	(V)	(mA)	(V)	( $\mu$ p)	(mV/°C)
SMBJ10 ♦	KW	SMBJ10C	AW	10	5	11.1	1	18.8	31.9	10
SMBJ10A ♦	KX	SMBJ10CA	AX	10	5	11.1	1	17.0	35.3	10
SMBJ11	KY	SMBJ11C	AY	11	5	12.2	1	20.1	29.9	11
SMBJ11A	KZ	SMBJ11CA	AZ	11	5	12.2	1	18.2	33.0	11
SMBJ12 ♦	LD	SMBJ12C ♦	BD	12	5	13.3	1	22.0	27.3	12
SMBJ12A ♦	LE	SMBJ12CA ♦	BE	12	5	13.3	1	19.0	30.2	12
SMBJ13	LF	SMBJ13C	BF	13	5	14.4	1	23.9	25.2	13
SMBJ13A	LG	SMBJ13CA	BG	13	5	14.4	1	21.5	27.9	13
SMBJ14	LH	SMBJ14C	BH	14	5	15.6	1	26.8	23.3	14
SMBJ14A	LK	SMBJ14CA	BK	14	5	15.6	1	23.2	25.8	14
SMBJ15 ♦	LL	SMBJ15C ♦	BL	15	5	16.7	1	26.9	22.3	15
SMBJ15A ♦	LM	SMBJ15CA ♦	BM	15	5	16.7	1	24.4	24.0	15
SMBJ16	LN	SMBJ16C	BN	16	5	17.8	1	27.8	20.8	16
SMBJ16A	LP	SMBJ16CA	BP	16	5	17.8	1	24.0	23.1	17
SMBJ17	LQ	SMBJ17C	BQ	17	5	18.9	1	30.5	19.7	20
SMBJ17A	LR	SMBJ17CA	BR	17	5	18.9	1	27.6	21.7	19
SMBJ18	LS	SMBJ18C	BS	18	5	20.0	1	32.2	18.8	21
SMBJ18A	LT	SMBJ18CA	BT	18	5	20.0	1	29.2	20.5	20
SMBJ20	LU	SMBJ20C	SU	20	5	22.2	1	35.6	16.7	25
SMBJ20A	LV	SMBJ20CA	BV	20	5	22.2	1	32.4	18.5	23
SMBJ22	LW	SMBJ22C	BW	22	5	24.4	1	39.3	15.2	28
SMBJ22A	LX	SMBJ22CA	BX	22	5	24.4	1	35.5	16.9	25
SMBJ24 ♦	LY	SMBJ24C ♦	BY	24	5	26.7	1	43.0	14.0	31
SMBJ24A ♦	LZ	SMBJ24CA ♦	BZ	24	5	26.7	1	38.9	15.4	28
SMBJ26	MD	SMBJ26C	CD	26	5	28.9	1	48.6	12.4	31
SMBJ26A	ME	SMBJ26CA	CE	26	5	28.9	1	42.1	14.2	30
SMBJ28 ♦	MF	SMBJ28C ♦	CF	28	5	31.1	1	50.0	12.0	35
SMBJ28A ♦	MG	SMBJ28CA ♦	CG	28	5	31.1	1	45.4	13.2	31
SMBJ30	MH	SMBJ30C	CH	30	5	33.3	1	53.5	11.2	39
SMBJ30A	MK	SMBJ30CA	CK	30	5	33.3	1	49.4	12.4	36
SMBJ33 ♦	ML	SMBJ33C ♦	CL	33	5	36.7	1	59.0	10.2	42
SMBJ33A ♦	MM	SMBJ33CA ♦	CM	33	5	36.7	1	53.3	11.3	39
SMBJ36	MN	SMBJ36C	CN	36	5	40.0	1	64.3	9.3	48
SMBJ36A	MP	SMBJ36CA	CP	36	5	40.0	1	58.1	10.3	41
SMBJ40 ♦	MQ	SMBJ40C ♦	CQ	40	5	44.4	1	71.4	8.4	51
SMBJ40A ♦	MR	SMBJ40CA ♦	CR	40	5	44.4	1	64.5	9.3	46
SMBJ43	MS	SMBJ43C	CS	43	5	47.8	1	76.7	7.8	55
SMBJ43A	MT	SMBJ43CA	CT	43	5	47.8	1	69.4	8.6	50
SMBJ45	MU	SMBJ45C	CU	45	5	50.0	1	80.3	7.5	58
SMBJ45A	MV	SMBJ45CA	CV	45	5	50.0	1	72.7	8.3	52
SMBJ48	MW	SMBJ48C	CW	48	5	53.3	1	85.5	7.0	63
SMBJ48A	MX	SMBJ48CA	CX	48	5	53.3	1	77.4	7.7	58
SMBJ51	MY	SMBJ51C	CY	51	5	56.7	1	91.1	6.6	66
SMBJ51A	MZ	SMBJ51CA	CZ	51	5	56.7	1	82.4	7.3	61
SMBJ54	ND	SMBJ54C	DD	54	5	60.0	1	98.3	6.2	71
SMBJ54A	NE	SMBJ54CA	DE	54	5	60.0	1	87.1	6.9	65
SMBJ58 ♦	NF	SMBJ58C ♦	DF	58	5	64.4	1	103.0	5.8	78
SMBJ58A ♦	NG	SMBJ58CA ♦	DG	58	5	64.4	1	93.6	6.4	70
SMBJ60	NH	SMBJ60C	DH	60	5	66.7	1	107.0	5.6	80
SMBJ60A	NK	SMBJ60CA	DK	60	5	66.7	1	98.8	6.2	71
SMBJ64 ♦	NL	SMBJ64C ♦	DL	64	5	71.1	1	114.0	5.3	86
SMBJ64A ♦	NM	SMBJ64CA ♦	DM	64	5	71.1	1	103.0	5.8	76
SMBJ70	NN	SMBJ70C	DN	70	5	77.8	1	125	4.8	94
SMBJ70A	NP	SMBJ70CA	DP	70	5	77.8	1	113	5.3	85
SMBJ75	NQ	SMBJ75C	DQ	75	5	83.3	1	134	4.5	101
SMBJ75A	NR	SMBJ75CA	DR	75	5	83.3	1	121	4.9	91
SMBJ78	NS	SMBJ78C	DS	78	5	86.7	1	139	4.3	105
SMBJ78A	NT	SMBJ78CA	DT	78	5	86.7	1	126	4.7	95
SMBJ85	NV	SMBJ85C	DV	85	5	94.4	1	151	3.9	114
SMBJ85A	NW	SMBJ85CA	DW	85	5	94.4	1	137	4.4	103
SMBJ90	NX	SMBJ90C	DX	90	5	100	1	160	3.8	121
SMBJ90A	NY	SMBJ90CA	DX	90	5	100	1	148	4.1	110
SMBJ100	NZ	SMBJ100C	DY	100	5	111	1	179	3.4	135
SMBJ100A	NZ	SMBJ100CA	DZ	100	5	111	1	162	3.7	123
SMBJ110	PD	SMBJ110C	ED	110	5	122	1	188	3.0	148
SMBJ110A	PE	SMBJ110CA	EE	110	5	122	1	177	3.4	133
SMBJ120	PF	SMBJ120C	EF	120	5	133	1	214	2.8	162
SMBJ120A	PG	SMBJ120CA	EG	120	5	133	1	193	3.1	146
SMBJ130	PH	SMBJ130C	EH	130	5	144	1	231	2.6	175
SMBJ130A	PK	SMBJ130CA	EK	130	5	144	1	209	2.9	158
SMBJ150	PL	SMBJ150C	EL	150	5	167	1	266	2.2	203
SMBJ150A	PM	SMBJ150CA	EM	150	5	167	1	243	2.5	184
SMBJ160	PN	SMBJ160C	EN	160	5	178	1	287	2.1	217
SMBJ160A	PP	SMBJ160CA	EP	160	5	178	1	258	2.3	196
SMBJ170	PQ	SMBJ170C	EQ	170	5	189	1	304	2.0	230
SMBJ170A	PR	SMBJ170CA	ER	170	5	189	1	275	2.2	208

NOTE 1: "A" =  $\pm 5\%$  of nominal V<sub>BR</sub>, standard tolerance is  $\pm 10\%$ .  
 NOTE 2: Bidirectional devices have symmetrical avalanche characteristics in both directions.  
 NOTE 3: For bidirectional devices with V<sub>RRM</sub>  $\leq$  10 volts, the IR limit is doubled.  
 ♦ : Popular / Recommended part types

### PEAK PULSE POWER vs. PULSE TIME

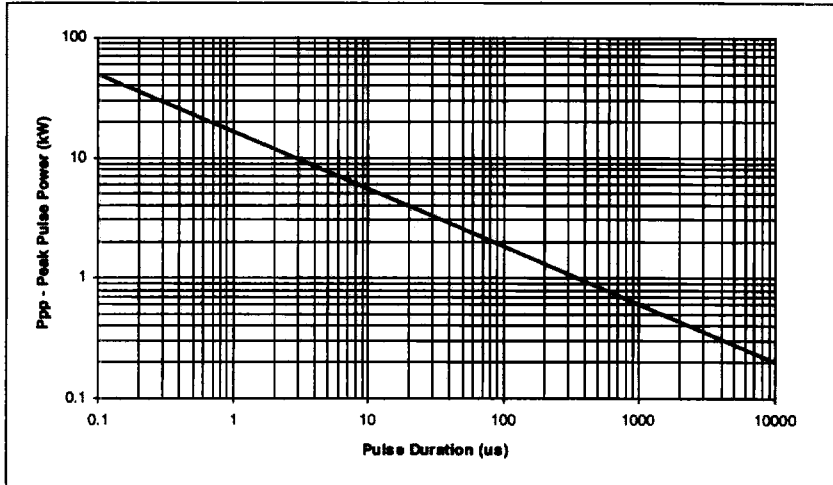

### PULSE DERATING CURVE

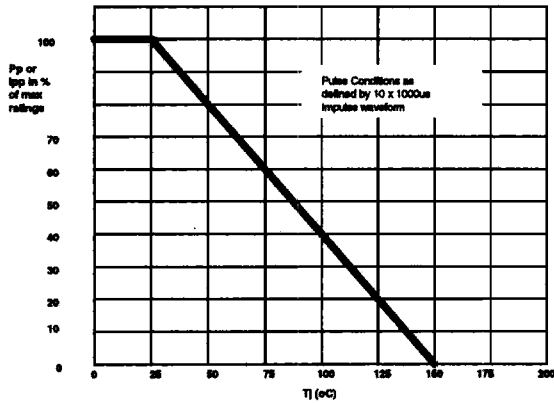

### 10x1000μs IMPULSE WAVEFORM

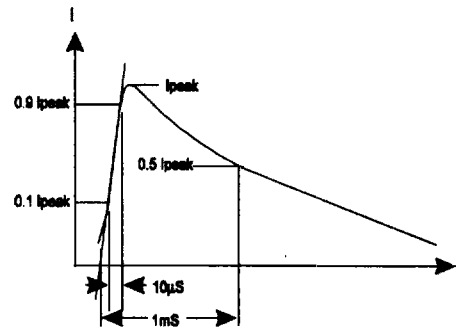

### CAPACITANCE vs. WORKING VOLTAGE

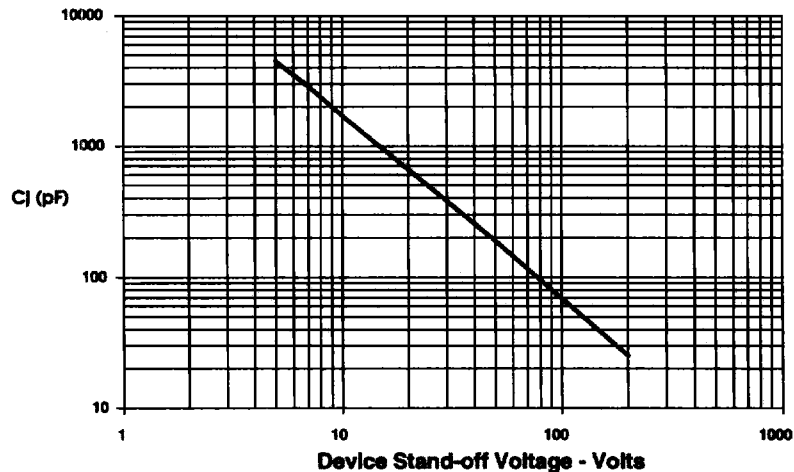

#### MECHANICAL OUTLINE & LAND PATTERN - DO-214AA

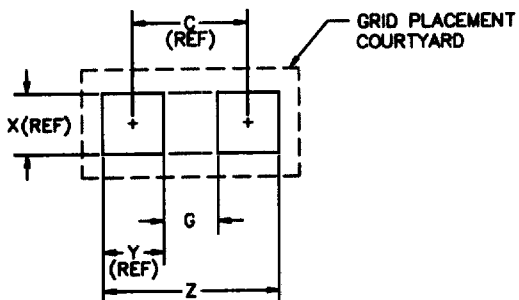
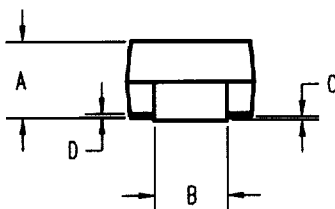
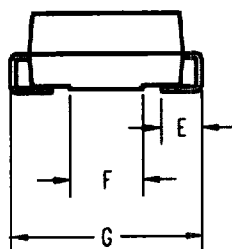
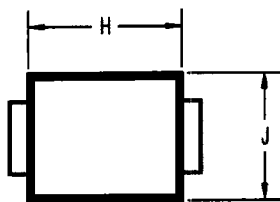

DIM #	INCHES		MM		NOTE
	MIN	MAX	MIN	MAX	
A	.075	.095	1.90	2.41	
B	.075	.085	1.90	2.15	
C	.004	.008	.10	.20	
D		.020	-	.51	
E	.030	.060	.76	1.52	
F	.065	.084	1.65	2.13	
G	.201	.220	5.10	5.58	
H	.160	.181	4.06	4.60	
J	.130	.154	3.30	3.90	

DIM #	INCHES		MM		NOTE
	MIN	MAX	MIN	MAX	
C	-	.172	-	4.40	-
G	.080	.086	2.00	2.20	-
X	.086	.090	2.20	2.40	-
Y	-	.090	-	2.40	-
Z	.260	.270	6.60	6.80	-

Note : Grid placement courtyard is 8 x 16 elements (4mm x 8mm) in accordance with the international grid detailed in IEC publication 97.

#### TYPICAL APPLICATION : IC PROTECTION

Transient protection for integrated circuits is recommended at the power supply line and signal line interfaces which exit the equipment. A generic application is shown below.

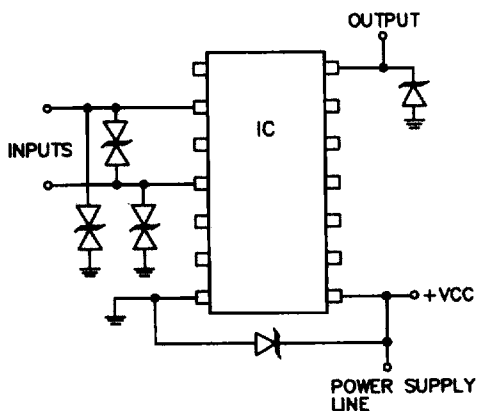

## X-ON Electronics

Largest Supplier of Electrical and Electronic Components

*Click to view similar products for [ESD Suppressors / TVS Diodes](#) category:*

*Click to view products by [Semtech](#) manufacturer:*

Other Similar products are found below :

[60KS200C](#) [D12V0H1U2WS-7](#) [D18V0L1B2LP-7B](#) [82356050220](#) [D5V0M5U6V-7](#) [NTE4902](#) [P4KE27CA](#) [P6KE11CA](#) [P6KE39CA-TP](#)  
[P6KE8.2A](#) [SA110CA](#) [SA60CA](#) [SA64CA](#) [SMBJ12CATR](#) [SMBJ8.0A](#) [SMLJ30CA-TP](#) [ESD101-B1-02ELS E6327](#) [ESD112-B1-02EL E6327](#)  
[ESD119B1W01005E6327XTSA1](#) [ESD5V0L1B02VH6327XTSA1](#) [ESD7451N2T5G](#) [19180-510](#) [CPDT-5V0USP-HF](#) [3.0SMCJ33CA-F](#)  
[3.0SMCJ36A-F](#) [HSPC16701B02TP](#) [D3V3Q1B2DLP3-7](#) [D55V0M1B2WS-7](#) [DESD5V0U1BL-7B](#) [DRTR5V0U4SL-7](#) [SCM1293A-04SO](#)  
[ESD200-B1-CSP0201 E6327](#) [ESD203-B1-02EL E6327](#) [SM12-7](#) [SMF8.0A-TP](#) [SMLJ45CA-TP](#) [CEN955 W/DATA](#) [82350120560](#)  
[82356240030](#) [VESD12A1A-HD1-GS08](#) [CPDUR5V0R-HF](#) [CPDUR24V-HF](#) [CPDQC5V0U-HF](#) [CPDQC5V0USP-HF](#) [CPDQC5V0-HF](#)  
[D1213A-01LP4-7B](#) [D1213A-02WL-7](#) [ESDLIN1524BJ-HQ](#) [5KP100A](#) [5KP15A](#)