

SX8650 Evaluation Kit

User's Guide

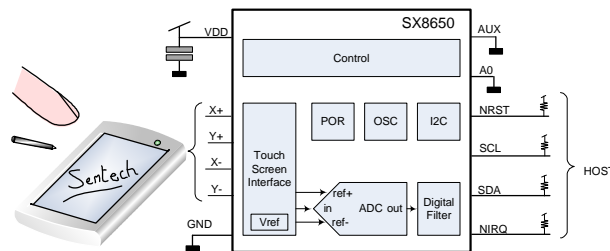

Resistive Touch Solutions
SX8650 4-wire controller with I2C interface



SX8650EVKA

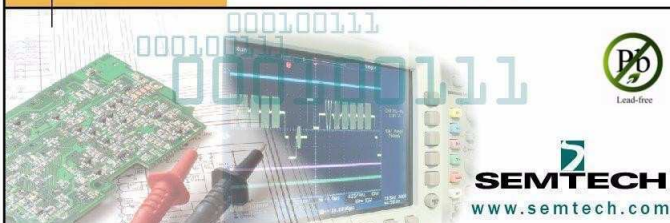



Lead-free

Table of contents

Section	Page
1. General Description	3
2. Hardware Description	3
2.1. Overview	3
2.2. Content	3
2.3. Board	3
2.3.1. Connection to the SX8650	3
2.4. Power and analog Interface	4
2.5. Digital Interface	5
3. Software Description.....	5
3.1. Overview	5
3.2. Installation.....	5
3.3. Connecting the EVK.....	5
3.4. Starting the GUI	6
3.5. Measurements	6
3.5.1. Overview	6
3.5.2. Auxiliary Channel	6
3.6. Throughput.....	7
3.6.1. Overview	7
3.7. Touch Screen Setup	8
3.7.1. Overview	8
3.8. I2C Setup	8
3.8.1. Overview	8
3.9. Extras.....	9
3.9.1. Overview	9
3.10. Display Registers	10
3.10.1. Overview	10
3.11. Convert	11
3.11.1. Overview	11
3.12. View Graph / View Touch Screen	11
3.12.1. Overview	11
3.13. Clear Data.....	12
3.13.1. Overview	12
3.14. Change Operation Mode.....	12
3.14.1. Overview	12
3.15. Connected/Disconnected.....	12
3.15.1. Overview	12
3.16. Quit	12
3.16.1. Overview	12
3.17. Schematics	13
3.18. Board outline.....	14
4. References	14

1. General Description

This user's guide describes the characteristics, operation, and use of the SX8650EVK. This evaluation module is a 4-wire touch screen controller which also has auxiliary input. The hardware and software description and the schematic diagram are included.

2. Hardware Description

2.1. Overview

The SX8650EVK is the board for evaluation of the 4-wire resistive touch screen controller SX8650. Since SX8650EVK is provided with a touch-panel, it is easy to check the functionality of the chip.

The EVK and its supporting documentation allows for customers to develop software that can be used in eventual implementations. No external supply is needed to power the board. A USB cable is provided to connect the EVK to a Windows based PC for operation of the software.

2.2. Content

The evaluation kit is composed of the following parts:

- ◆ The board with the SX8650 and the touch screen on the top
- ◆ A USB cable to connect the board to the PC
- ◆ A CDROM with the installation files and the user guide
- ◆ A stylus to write on the touch screen

2.3. Board

The board is split in 2 areas. From the bottom view (component side), the left area is the interface between the USB of the PC and the SX8650. The right area is dedicated to the SX8650 and the touch screen connectors.

The S_ON switch is the SX8650 power supply switch. A red led is lighted in the ON position. When it is switch off the SX8650 is not supplied but the interface circuitry is still powered on.

2.3.1. Connection to the SX8650

The left side of JP1 (odd number) is connected to the SX8650 host and the power pins.

The right side of JP1 (even number) is connected to the interface pins of the SX8650.

The jumpers allow the connection between the host and the SX8650. If an external host, power supply, or auxiliary input should be used, the jumper would be removed.

Pin Number	Signal	Description
JP1(1-3)	GND_0	Ground
JP1(3-4)	V3V3	1.85V, 3.3V or external supply voltage
JP1(5-6)	V3V3PU	Unused
JP1(7-8)	SCL	I2C bus serial clock
JP1(9-10)	SDA	I2C bus data line
JP1(11-12)	NRST	SX8650 Reset pin
JP1(13-14)	NIRQ	SX8650 interrupt pin
JP1(15-16)	A0	SX8650 I2C address selection
JP1(17-18)	AUX	SX8650 Auxiliary input
JP1(19-20)	V3V3reg	Unused

Table 1 JP1 Pinout

J3 header gives access to the J1 or J4 touch screen connectors. The jumpers set in the left vertical row of J3 enable the connection to J1 connector.

The jumpers set in the horizontal way of J3 enable the connection to J4 connector.

A direct connection via J3 can also be made to adapt other panel connections.

Pin Number	Signal	Description
J3(3)	Y-	4-wire touch screen Y- plate voltage supply
J3(7)	X-	4-wire touch screen X- plate voltage supply
J3(11)	Y+	4-wire touch screen Y+ plate voltage supply
J3(15)	X+	4-wire touch screen X+ plate voltage supply
J3(17-19)	GND_0	Ground

Table 2: J3 pinout

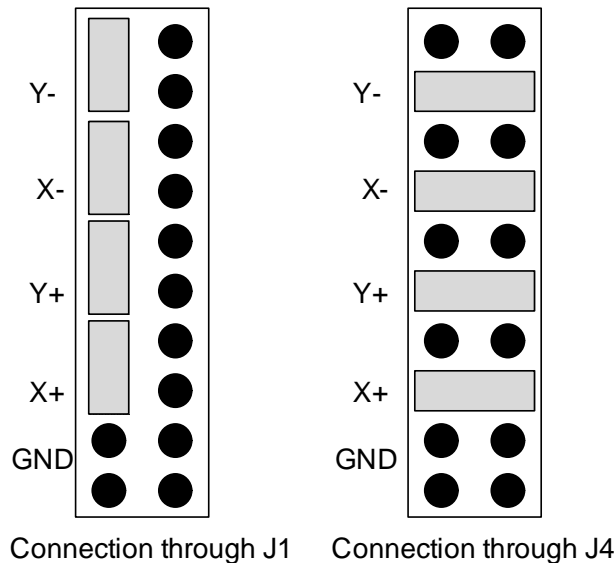

Figure 1. Connection for J1 or J4 connectors

2.4. Power and analog Interface

For maximum flexibility, the SX8650EVK is designed for easy interfacing to multiple analog-sources.

The board is powered from the USB. The S_V switch allows the user to test the SX8650 to 3.3V (switch to the left) or 1.85V (switch to the right).

If the user want to test the chip with a different supply voltage then the jumper JP1 (3-4) should be removed and an external voltage connected to JP1 (4). The SX8650 supply voltage range goes from 1.65V to 3.7V.

JP1 (18) gives access to the AUX input.

If the AUX input of the SX8650 is configured as an analog input, an arbitrary signal generator or any analog signal can be connected on JP1(18).

If the AUX input of the SX8650 is configured to be used as a trigger for conversion, then a square wave generator or any digital signal can be connected to JP1(18).

2.5. Digital Interface

JP1 header also gives access to the digital control and serial data pins of the SX8650.

If an external host is used to test the part, the jumpers JP1 (7-8), JP1 (9-10), JP1 (11-12), JP1 (13-14) should be removed and the SCL, SDA, NRST and NIRQ signals respectively connected to JP1 (8), JP1 (10), JP1 (12), JP1 (14).

3. Software Description

3.1. Overview

The software is constructed with graphical aids such as radio buttons and check boxes so each setting on the device can easily be seen in a human readable display along with what the particular setting means. No experience in software programming is needed to operate the EVK or the SX8650 basic functions.

3.2. Installation

This software requires a Windows 2000/XP/Vista operating system. The software is installed via an installation program. This is called "SX8650EvaluationKitSetup.exe". The software will check to see if .NET 3.5 (which is required for the software) is installed. If it is not, the program will download it from Microsoft and install .NET (NOTE: A reboot may be required). After the software is installed, FTDI drivers will automatically be (re)installed. After the software is installed, you should plug the USB connection from the EVK to the PC to complete the installation.

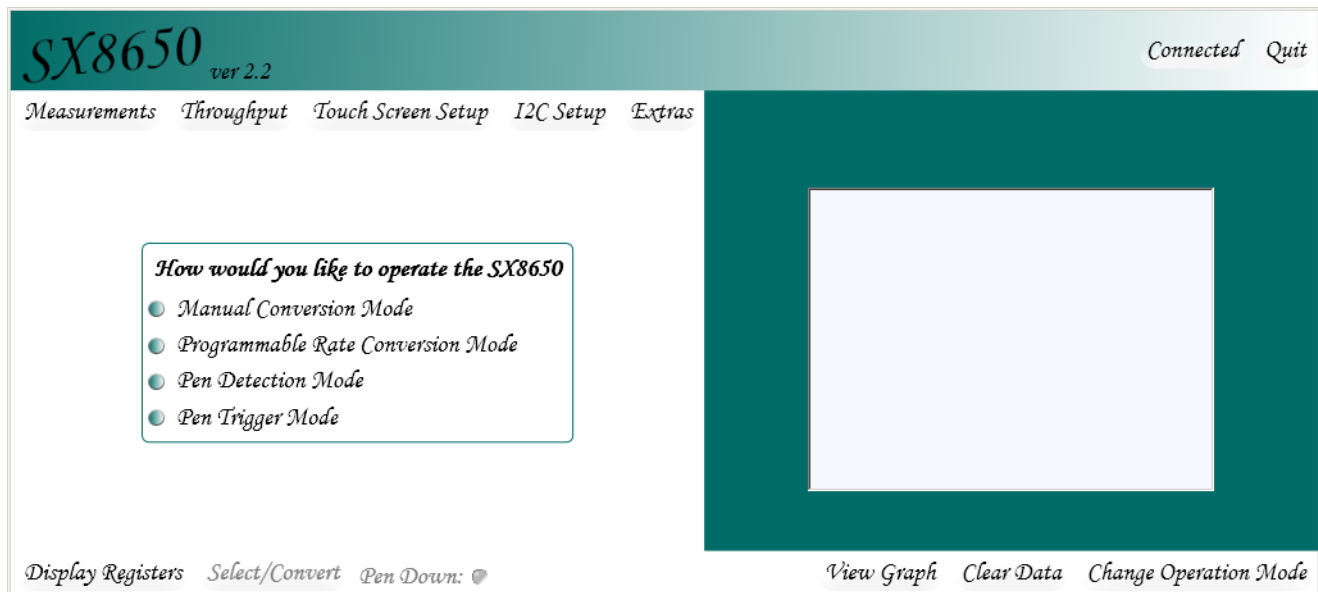

Figure 2. First launch of the SX8650 GUI

Before starting the installation, the EVK must be connected through the USB to the PC and recognized by Windows. By default, the setup program will install a shortcut to the software in your start menu.

3.3. Connecting the EVK

The USB cable that is provided will connect the EVK to the PC. The S_ON switch should be on the ON position. If the GUI is launched without an EVK connected and switched on, the program will show in the status that it is not connected. The

GUI will still show all features available and can be used as a quick demonstration or for specific debug operations. In order to connect the device once the GUI has been launched, the user must first connect the EVK to the PC via the USB cable.

3.4. Starting the GUI

After starting the GUI, a script will set the device to go into Pen Trigger Mode, enable X-Y to be measured, and then set up a small power delay. NOTE: Pen Trigger Mode is not selected on startup because this is a command and not a register. Commands cannot be read, whereas registers can be read.

Please do not disconnect the device while running the GUI. If it is desired to disconnect the EVK, close the GUI first.

3.5. Measurements

3.5.1. Overview

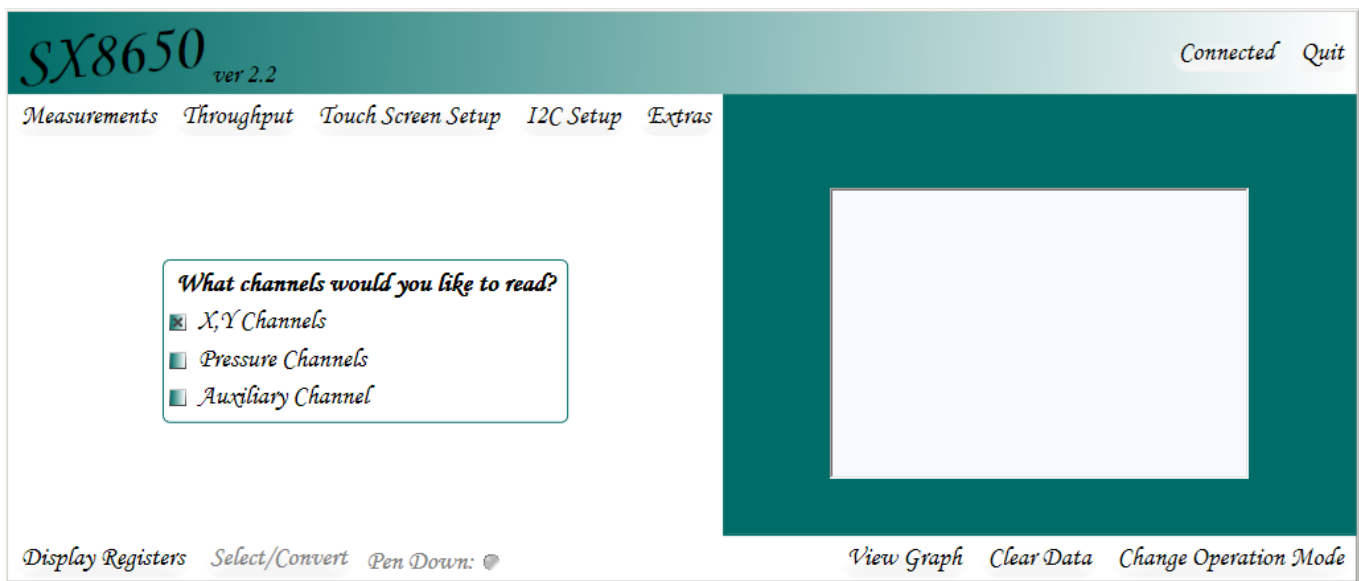

Figure 3. : Measurements

By clicking Measurements, the GUI will allow the user to select what channels to read. If the user is in Manual Conversion Mode and select Auxiliary Channel, a popup will appear to allow determining how to use the Auxiliary Channel.

3.5.2. Auxiliary Channel

3.5.2.1. Overview



Figure 4. Auxiliary Channel

When in Manual Conversion Mode, the user may use the AUX pin as a trigger to perform conversions or as a standard analog input.

3.6. Throughput

3.6.1. Overview

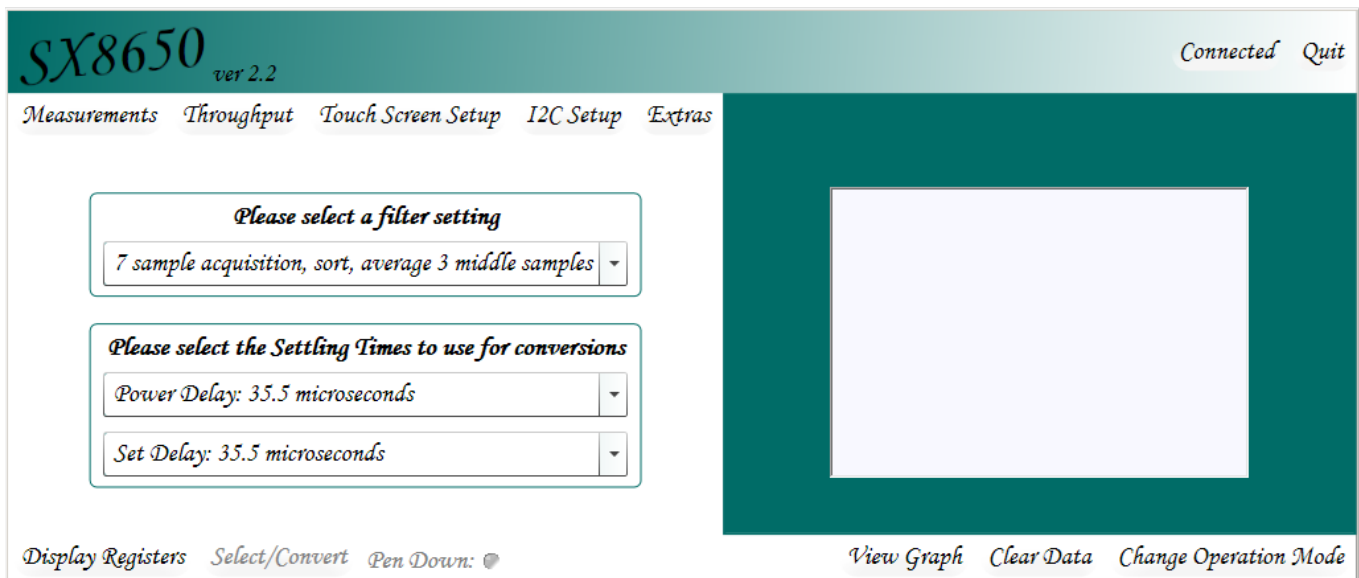

Figure 5. Throughput

ADVANCED COMMUNICATIONS & SENSING USER GUIDE

The throughput page allows the user to change items that would affect the throughput of the device. Items such as Power Delay and Set Delay may need to be changed from the default value depending on the touch screen used. NOTE: Set Delay is similar to Power Delay but only used when a filter is selected.

3.7. Touch Screen Setup

3.7.1. Overview

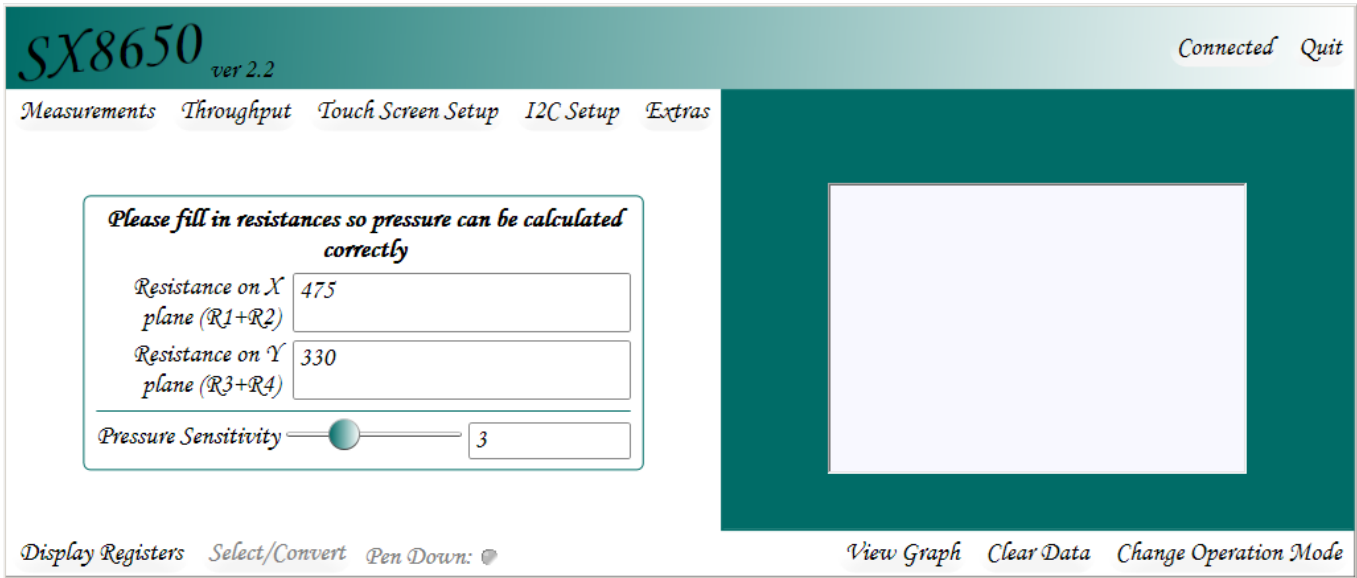

Figure 6. Touch Screen Setup

When using different touch screens, the Touch Screen Setup page may need to be used. Currently, it will setup Resistances on the X/Y planes which are used in calculating the pressure and also for determining the correct aspect ratio for the screen size. Pressure Sensitivity is the number to multiply the final pressure calculation. This creates a larger pen size for smaller pressure measurements. The default settings correspond to the touch screen used on the EVK.

3.8. I2C Setup

3.8.1. Overview

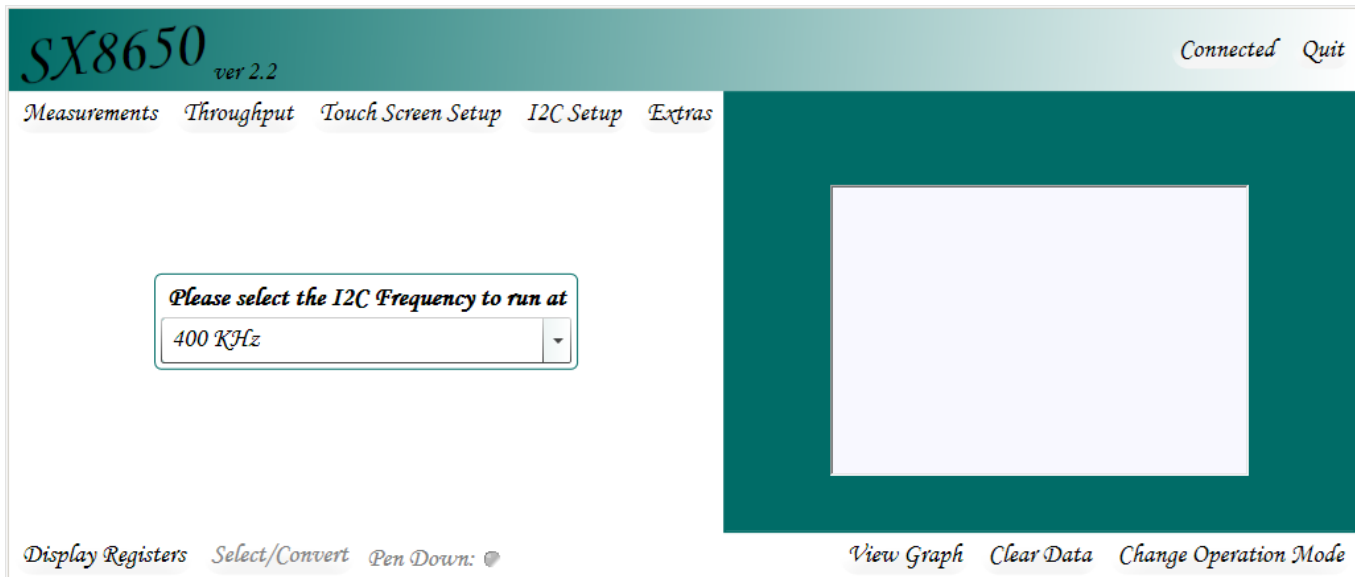

Figure 7. I2C Setup

This page is normally not needed but is available in case the user wants to try different I2C frequency settings. However, since the GUI is using Windows and a USB connection, there is a delay in between I2C commands because of the Operating System.

3.9. Extras

3.9.1. Overview

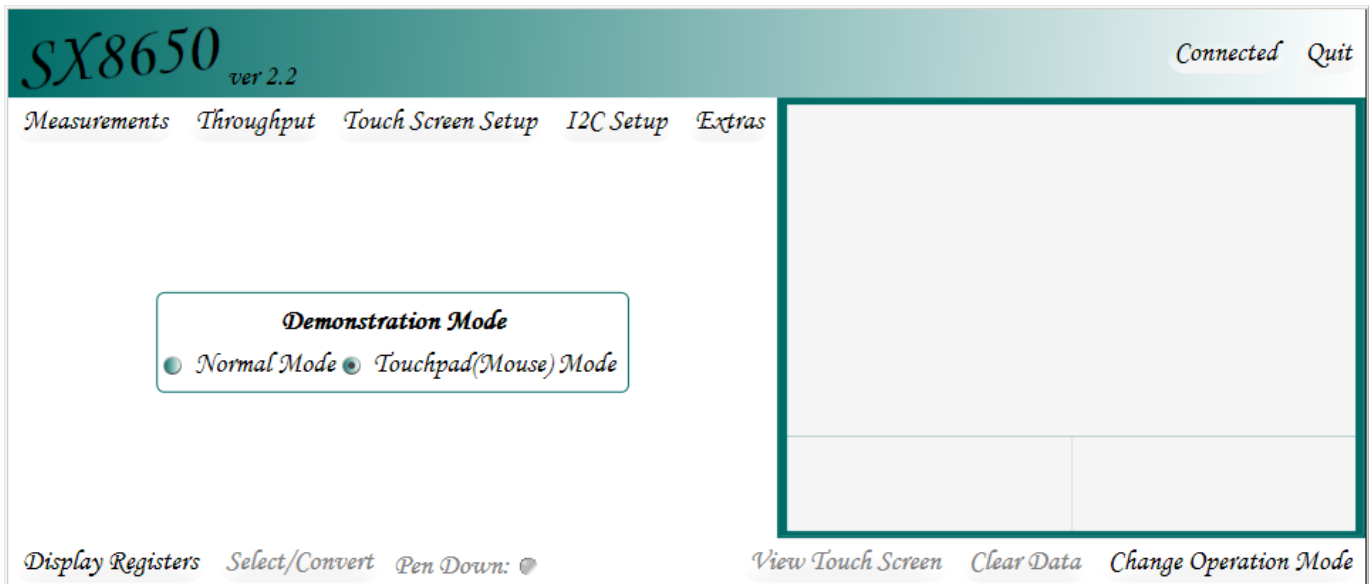

Figure 8. Extras

This area allows different demonstration modes to try out the touch screen with. Currently there is only one other mode, Touchpad Mode.

3.9.1.1. Touchpad Mode

This mode allows the touch screen to act similar to a standard touchpad.

There are:

- ◆ Left and Right Buttons
- ◆ Edge moving (this is when the user moves the finger to an edge and the mouse still moves in that direction).
- ◆ Left Clicking when just touching the touchpad area really fast.
- ◆ Dragging (when the user double clicks fast and on the second click moves around on the touchpad).
- ◆ All settings such as speed and button configuration (swapping of left and right buttons) are done through the control panel in the standard mouse section.

3.10. Display Registers

3.10.1. Overview

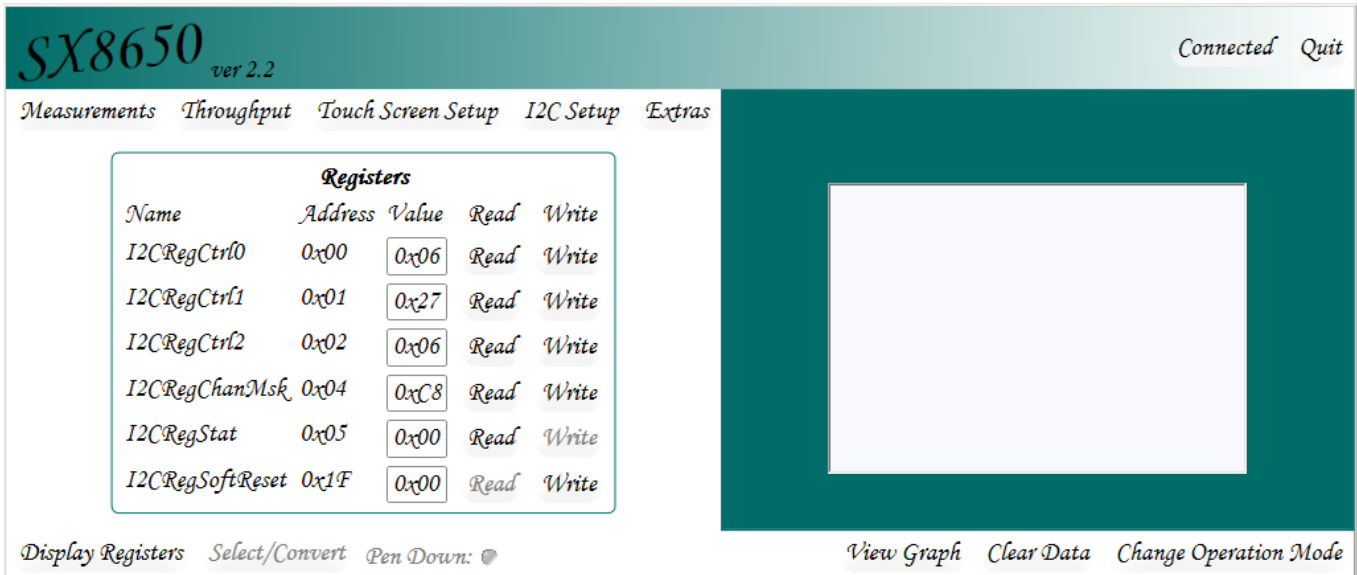

Registers				
Name	Address	Value	Read	Write
I2CRegCtrl0	0x00	0x06	Read	Write
I2CRegCtrl1	0x01	0x27	Read	Write
I2CRegCtrl2	0x02	0x06	Read	Write
I2CRegChanMsk	0x04	0xC8	Read	Write
I2CRegStat	0x05	0x00	Read	Write
I2CRegSoftReset	0x1F	0x00	Read	Write

Figure 9. Display Registers

If the user desires to view or modify the registers manually, he/she may do so on the Display Registers page.

3.11. Convert

3.11.1. Overview

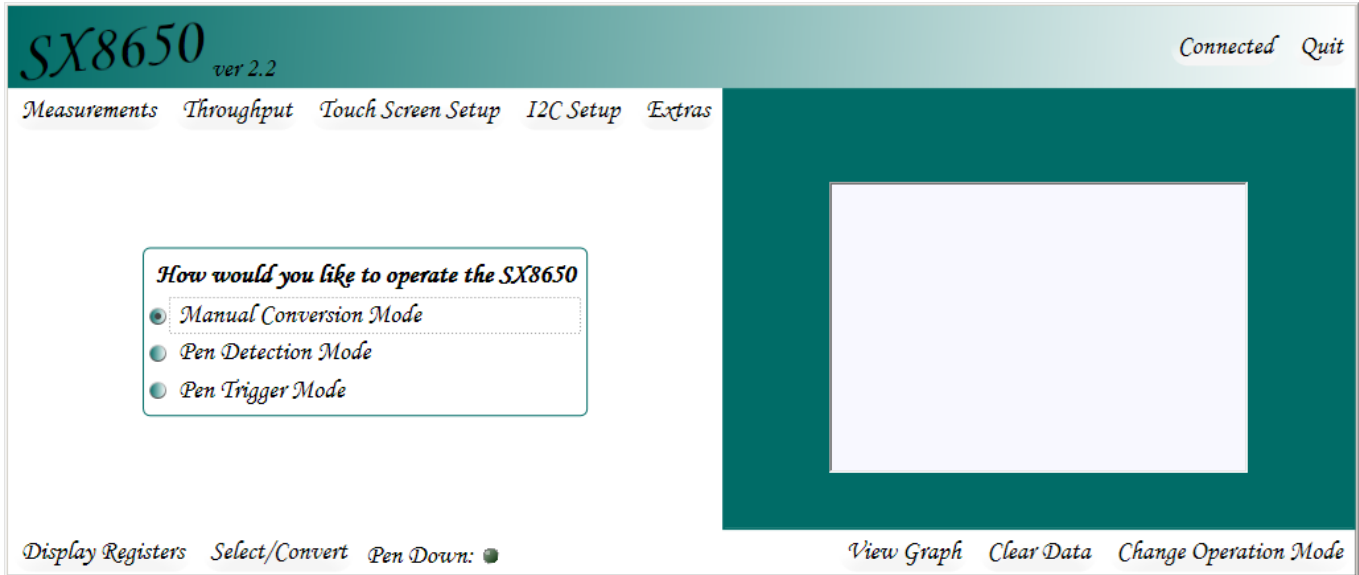

Figure 10. Pen Detection Mode with the Pen Down

The Select/Convert button is only available when in Manual Conversion Mod. This will perform a conversion with the channels selected on the Measurements page.

3.12. View Graph / View Touch Screen

3.12.1. Overview

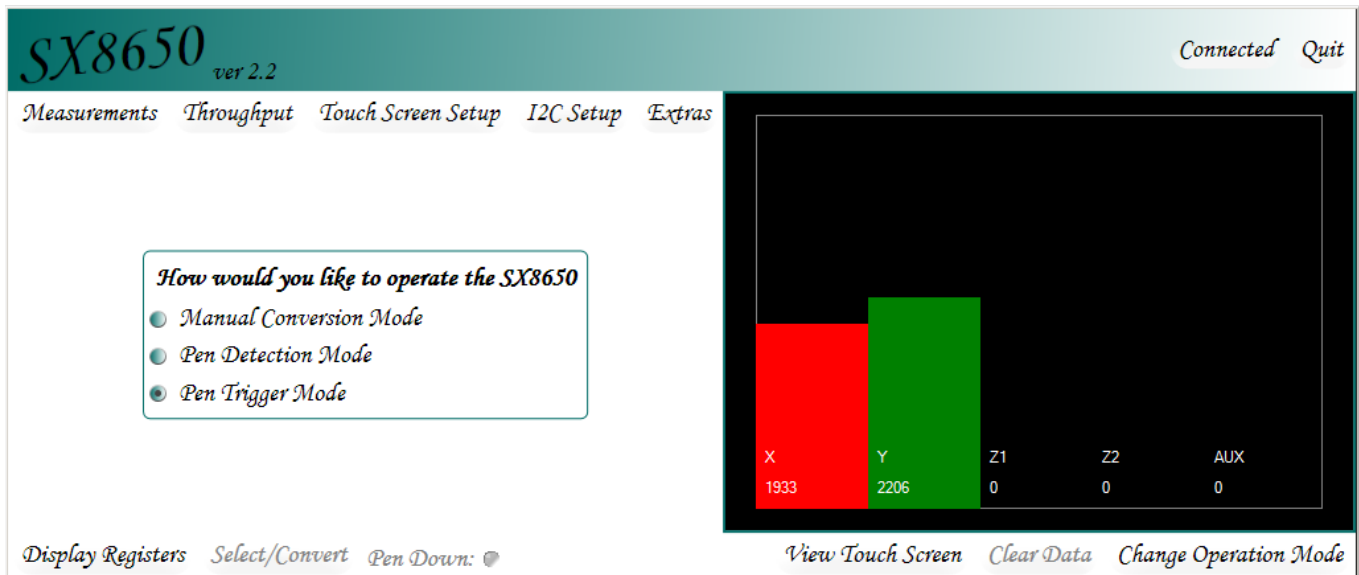

Figure 11. After user clicks View Graph and has touched the screen

The user may view a graph display of the data. To go back to a touch screen view, just click View Touch Screen

3.13. Clear Data

3.13.1. Overview

This button is only available when viewing the touch screen. The only function of it is to clear the screen.

3.14. Change Operation Mode

3.14.1. Overview

Clicking Change Operation Mode will allow the user to change the operation mode. The GUI will start up with this same page.

3.15. Connected/Disconnected

3.15.1. Overview

Clicking Connected will disconnect the EVK. When it says Disconnected, clicking the button causes a connect to occur.

3.16. Quit

3.16.1. Overview

Clicking the Quit button will close out the GUI.

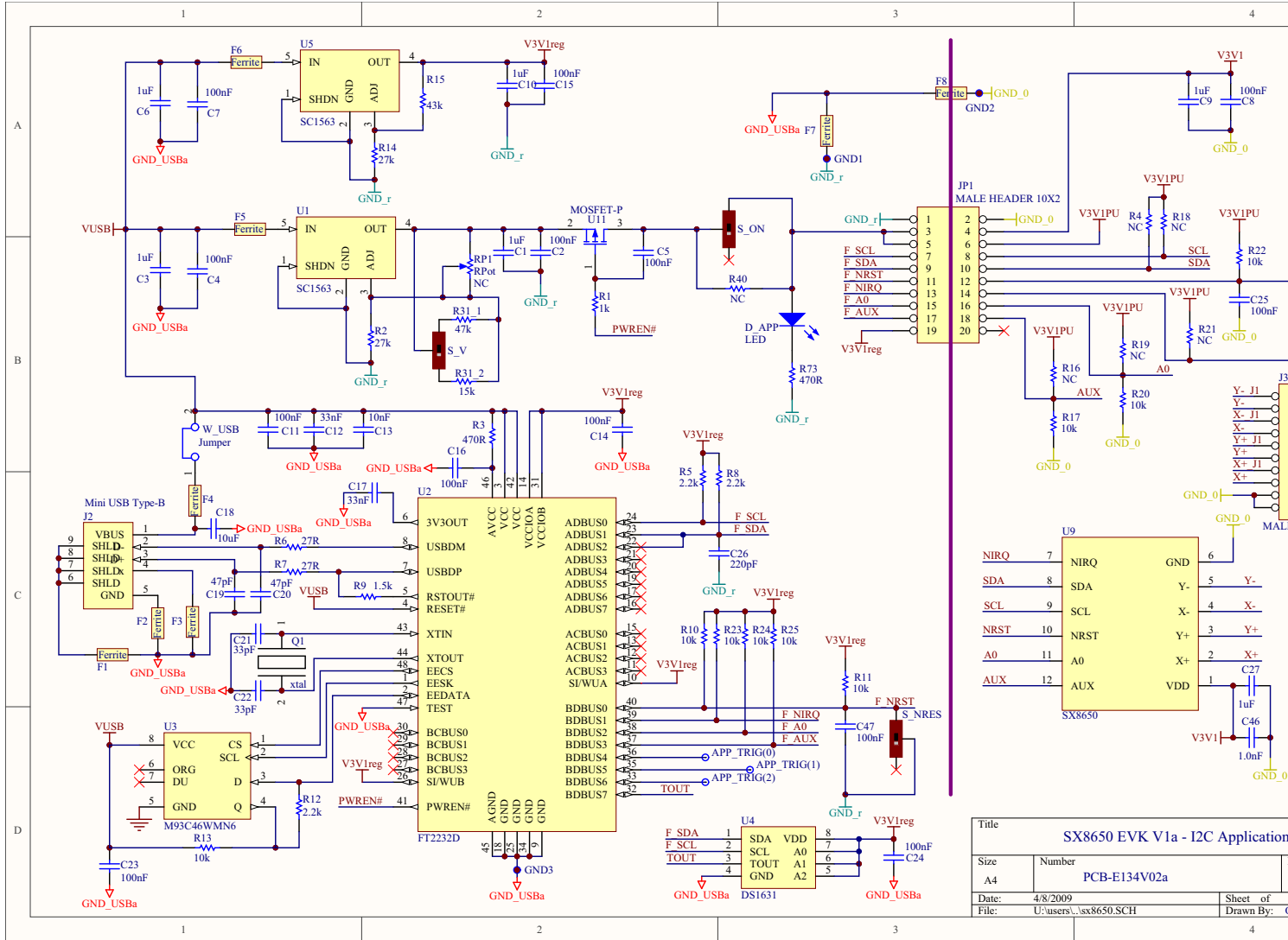

Title		SX8650 EVK V1a - I2C Application	
Size	Number	PCB-E134V02a	
A4			
Date:	4/8/2009	Sheet of	
File:	U:\users\l_sx8650.SCH	Drawn By:	

3.18. Board outline

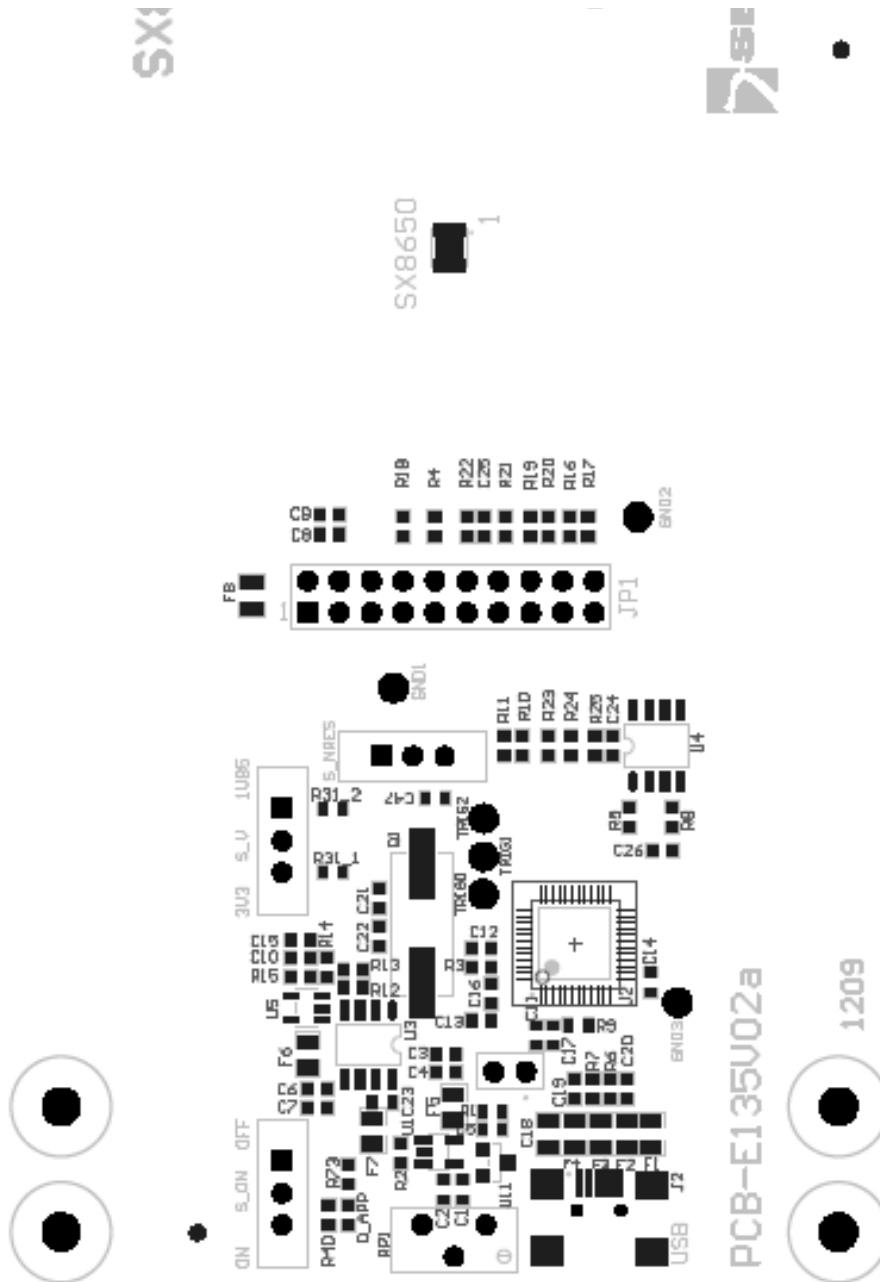

4. References

- ◆ [1] SX8650 Datasheet

© Semtech 2010

All rights reserved. Reproduction in whole or in part is prohibited without the prior written consent of the copyright owner. The information presented in this document does not form part of any quotation or contract, is believed to be accurate and reliable and may be changed without notice. No liability will be accepted by the publisher for any consequence of its use. Publication thereof does not convey nor imply any license under patent or other industrial or intellectual property rights. Semtech assumes no responsibility or liability whatsoever for any failure or unexpected operation resulting from misuse, neglect improper installation, repair or improper handling or unusual physical or electrical stress including, but not limited to, exposure to parameters beyond the specified maximum ratings or operation outside the specified range.

SEMTECH PRODUCTS ARE NOT DESIGNED, INTENDED, AUTHORIZED OR WARRANTED TO BE SUITABLE FOR USE IN LIFE-SUPPORT APPLICATIONS, DEVICES OR SYSTEMS OR OTHER CRITICAL APPLICATIONS. INCLUSION OF SEMTECH PRODUCTS IN SUCH APPLICATIONS IS UNDERSTOOD TO BE UNDERTAKEN SOLELY AT THE CUSTOMER'S OWN RISK. Should a customer purchase or use Semtech products for any such unauthorized application, the customer shall indemnify and hold Semtech and its officers, employees, subsidiaries, affiliates, and distributors harmless against all claims, costs damages and attorney fees which could arise.

All referenced brands, product names, service names and trademarks are the property of their respective owners.

Contact information

Semtech Corporation Advanced Communications & Sensing Products

E-mail: sales@semtech.com acsupport@semtech.com Internet: <http://www.semtech.com>

USA

200 Flynn Road, Camarillo, CA 93012-8790.
Tel: +1 805 498 2111 Fax: +1 805 498 3804

FAR EAST

12F, No. 89 Sec. 5, Nanking E. Road, Taipei, 105, TWN, R.O.C.
Tel: +886 2 2748 3380 Fax: +886 2 2748 3390

EUROPE

Semtech Ltd., Units 2 & 3, Park Court, Premier Way, Abbey Park Industrial Estate, Romsey, Hampshire, SO51 9DN.
Tel: +44 (0)1794 527 600 Fax: +44 (0)1794 527 601

X-ON Electronics

Largest Supplier of Electrical and Electronic Components

Click to view similar products for [Touch Sensor Development Tools](#) category:

Click to view products by [Semtech](#) manufacturer:

Other Similar products are found below :

[TSC2100EVM](#) [TSC2003EVM-PDK](#) [ATMXT1066T2-DEV-PCB](#) [ATMXT336UDEVPCB](#) [LC717A00ARGEVK](#) [ATMXT641TDAT-I2C-PCB](#)
[MAX20353EVSYS# 1374](#) [MIKROE-1906 1602](#) [SEN0164 1982](#) [STEVAL-PCC009V3](#) [ATSAMD20-QTRDEMO](#) [ATQT2-XPRO](#) [ATQT6-XPRO 2340](#) [DM160221](#) [DM160229](#) [DM160222](#) [ATQT5-XPRO](#) [DFR0129](#) [SEN0170](#) [SLEXP8019A](#) [SLEXP8018A 1375](#) [SEN0186](#)
[SEN0148](#) [ROB0103](#) [cs-useful-01](#) [DFR0385](#) [SEN0184](#) [SX8651EVKA 1362](#) [1580](#) [2024](#) [3575](#) [4830](#) [AS8579-TS_EK_DB](#) [ATQT600](#)
[IQS227/228ASEV01](#) [SKU-6515](#) [CY3280-MBR2](#) [CY3280-MBR3](#) [DFR0030](#) [DM160219](#) [AC160219](#) [AC320007](#) [ATEVK-MXT1066T2-A](#)
[ATEVK-MXT1189TAT-C](#)