

PROTECTION PRODUCTS - μClamp®

Description

The μClamp® TVS diodes are designed for automobile applications and qualified to AEC-Q100 Grade3. They offer superior electrical characteristics such as lower clamping voltage and no device degradation when compared to other technologies. They are designed to protect sensitive semiconductor components from damage or upset due to electrostatic discharge (ESD), lightning, electrical fast transients (EFT), and cable discharge events (CDE).

The μClamp®0301PQ is constructed using Semtech's proprietary EPD process technology. The EPD process provides low standoff voltages with significant reductions in leakage currents and capacitance over silicon-avalanche diode processes. They feature a true operating voltage of 3.0 volts for superior protection when compared to traditional pn junction devices. The μClamp0301PQ is in a 2-pin SLP1006P2 package measuring 1.0 x 0.6 x 0.5mm. The leads are spaced at a pitch of 0.65mm and are finished with lead-free NiPdAu. Each device will protect one line operating at 3.0 volts. It gives the designer the flexibility to protect single lines in applications where arrays are not practical. They may be used to meet the ESD immunity requirements of IEC 61000-4-2, Level 4 (±15kV air, ±8kV contact discharge) and above. The combination of small size and high ESD surge capability makes them ideal for use in automobile applications. The μClamp0301PQ is qualified to AEC-Q100 Grade 3.

Features

- ◆ Transient protection for data lines to **IEC 61000-4-2 (ESD)**
IEC 61000-4-4 (EFT)
Cable Discharge Event (CDE)
- ◆ Ultra-small package
- ◆ Protects one data line
- ◆ Low clamping voltage
- ◆ Working voltage: 3.0V
- ◆ Low leakage current
- ◆ Solid-state silicon-avalanche technology
- ◆ AEC-Q100 Grade 3 Qualified

Mechanical Characteristics

- ◆ SLP1006P2 package
- ◆ Pb-Free, Halogen Free, RoHS/WEEE Compliant
- ◆ Nominal Dimensions: 1.0 x 0.6 x 0.5 mm
- ◆ Lead Finish: NiPdAu
- ◆ Molding compound flammability rating: UL 94V-0
- ◆ Marking: Marking code, cathode band
- ◆ Packaging: Tape and Reel

Applications

- ◆ Automobile Applications
- ◆ Cellular Handsets & Accessories
- ◆ Notebooks & Handhelds
- ◆ Portable Instrumentation
- ◆ Digital Cameras
- ◆ Peripherals
- ◆ MP3 Players

Package Dimensions

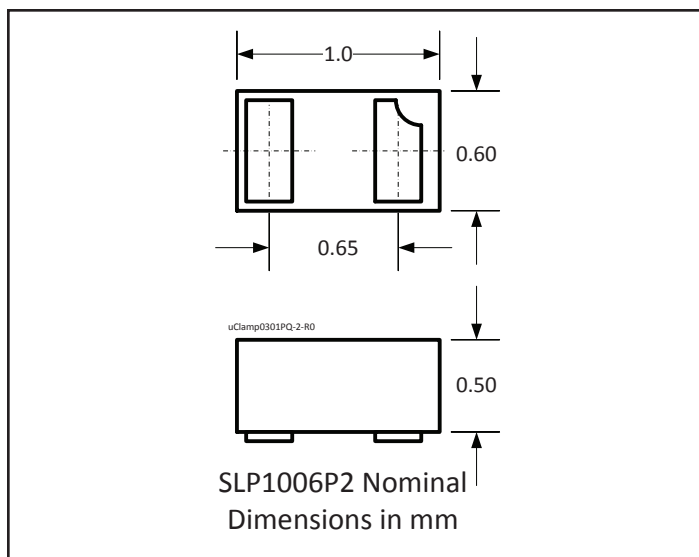

Schematic & Pin Configuration

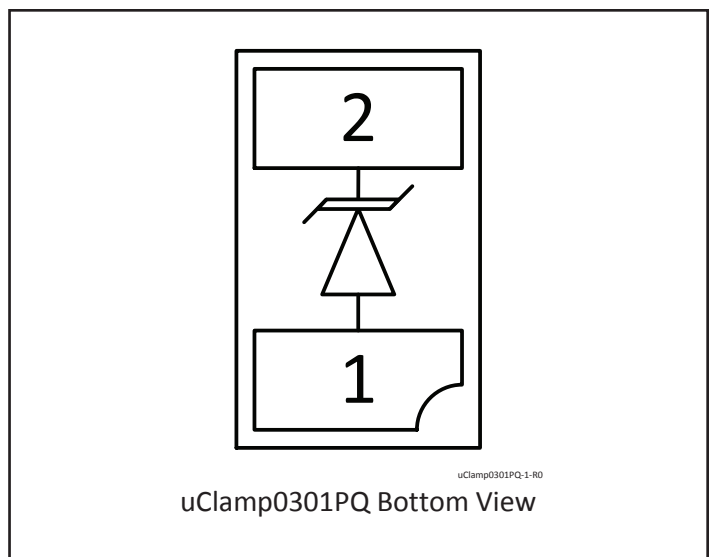

PROTECTION PRODUCTS

Absolute Maximum Ratings

Rating	Symbol	Value	Units
Peak Pulse Power (tp = 8/20μs)	P _{PK}	40	W
Peak Pulse Current (tp = 8/20μs)	I _{PP}	5	A
ESD per IEC 61000-4-2 (Air) ⁽¹⁾ ESD per IEC 61000-4-2 (Contact) ⁽¹⁾	V _{ESD}	±30 ±25	kV
Operating Temperature	T _J	-40 to +85	°C
Storage Temperature	T _{STG}	-55 to +150	°C

Notes:

(1): ESD Gun return path to Ground Reference Plane (GRP)

Electrical Characteristics (T=25°C unless otherwise specified)

Parameter	Symbol	Conditions	Min.	Typ.	Max.	Units	
Reverse Stand-Off Voltage	V _{RWM}				3.0	V	
Punch-Through Voltage	V _{PT}	I _{PT} = 2μA	3.1	3.9	4.6	V	
Snap-Back Voltage	V _{SB}	I _{SB} = 50mA	2.8				
Reverse Leakage Current	I _R	V _{RWM} = 3.0V		0.05	0.5	μA	
Clamping Voltage	V _C	I _{PP} = 1A, tp = 8/20μs			5.5	V	
Clamping Voltage	V _C	I _{PP} = 5A, tp = 8/20μs			8.0	V	
Reverse Clamping Voltage	V _{CR}	I _{PP} = 1A, tp = 8/20μs			2.4	V	
Junction Capacitance	C _J	I/O pin to GND f = 1MHz	V _R = 0V		25	30	pF
			V _R = 3.0V		18		

PROTECTION PRODUCTS

Typical Characteristics

Non-Repetative Peak Pulse Power vs. Pulse Time

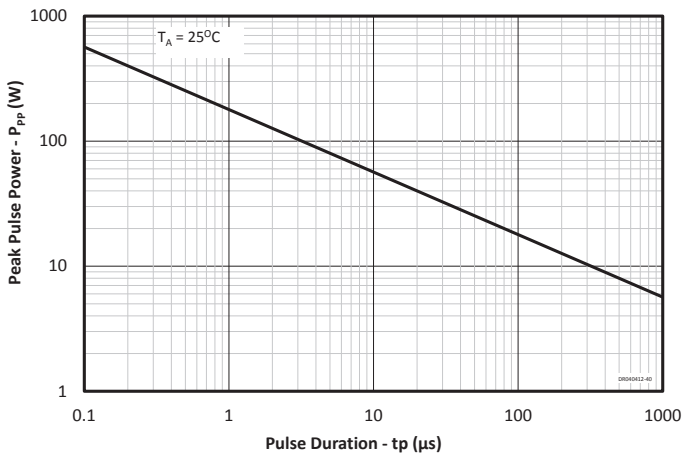

Power Derating Curve

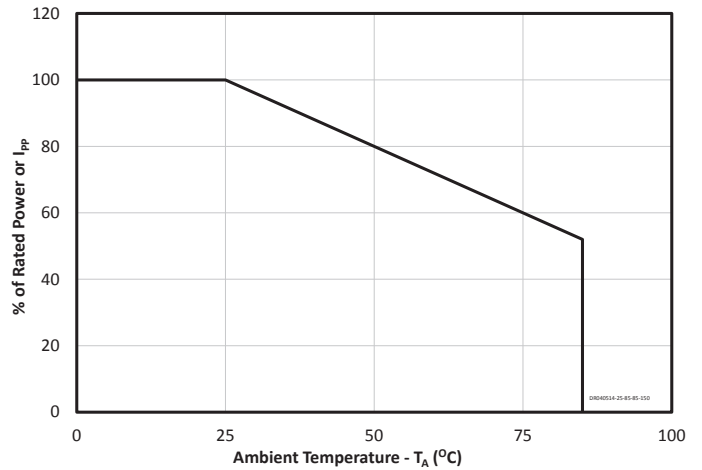

Reverse Leakage Current vs. Temperature

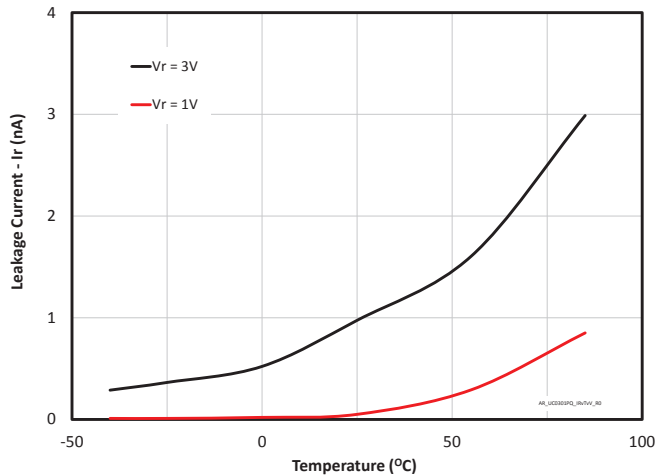

Capacitance vs. Temperature

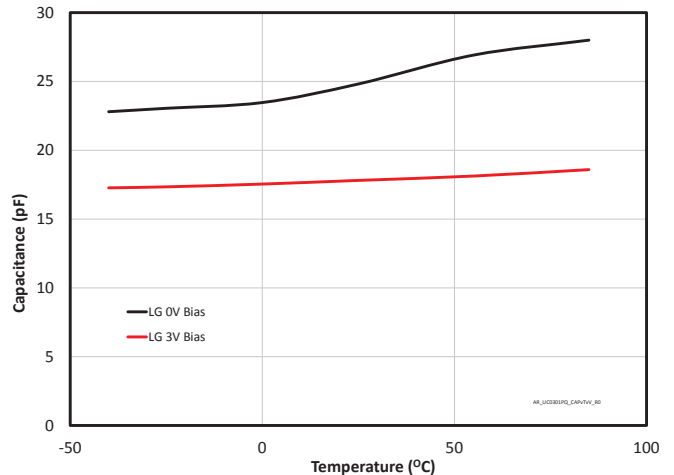

ESD Clamping Voltage +8kV Contact

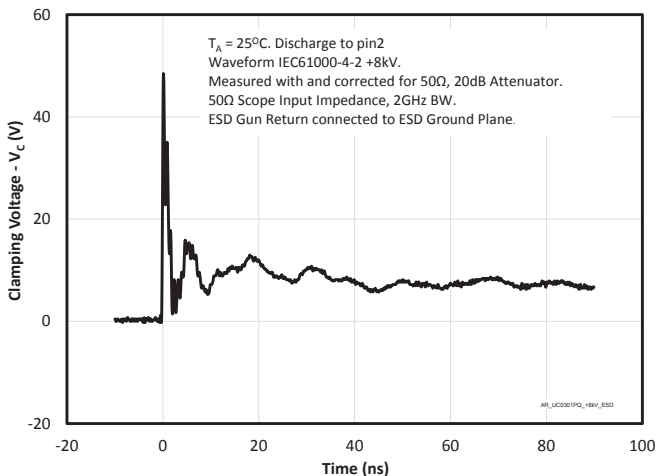

ESD Clamping Voltage -8kV Contact

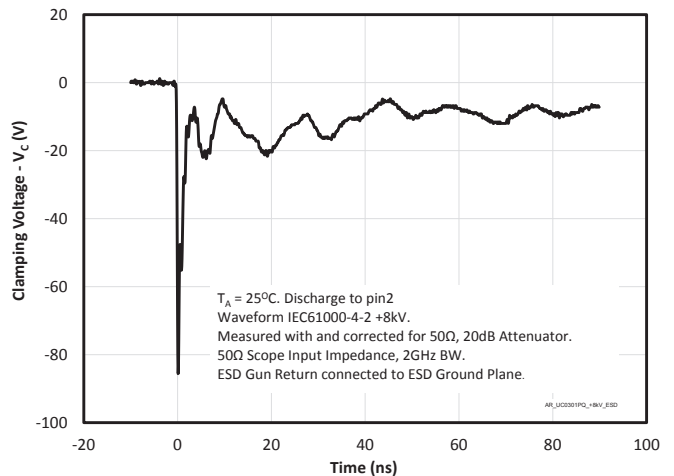

8x20us Clamping Performance Reverse

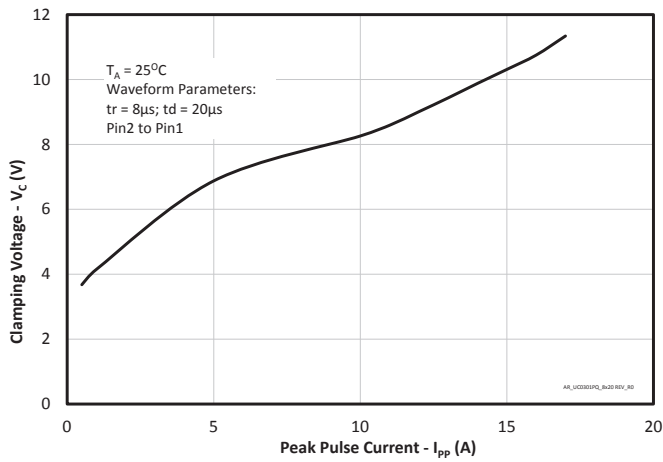

8x20us Clamping Performance Forward

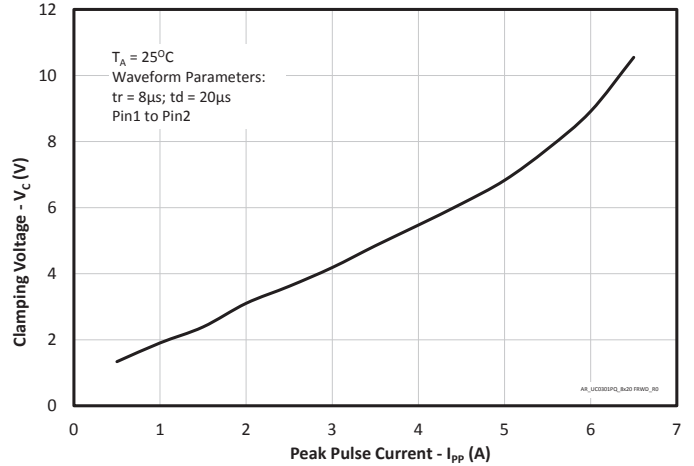

TLP Characteristics Reverse

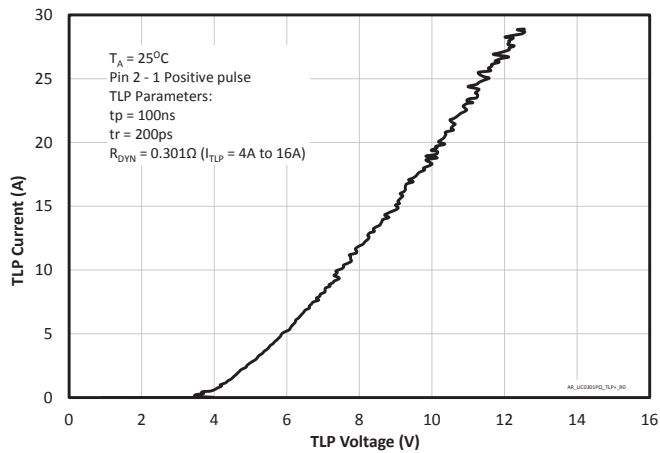

TLP Characteristics Forward

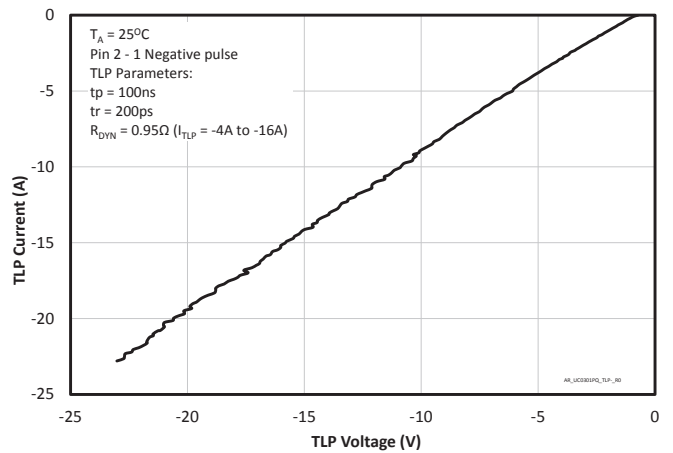

Device Connection Options

The μClamp0301PQ is designed to protect one data or I/O line operating at 3.0 volts. It will present a high impedance to the protected line up to 3.0 volts. It will “turn on” when the line voltage exceeds the punch thru voltage. The device is unidirectional and may be used on lines where the signal polarity is above ground. The cathode band should be placed towards the line that is to be protected. These devices should not be connected to DC supply rails as they can latch up as described below.

Due to the “snap-back” characteristics of the low voltage TVS, it is not recommended that the I/O line be directly connected to a DC source greater than snap-back voltage (VSB) as the device can latch on as described below.

EPD TVS Characteristics

The μClamp0301PQ is constructed using Semtech’s proprietary EPD technology. The structure of the EPD TVS is vastly different from the traditional pn-junction devices. At voltages below 5V, high leakage current and junction capacitance render conventional avalanche technology impractical for most applications. However, by utilizing the EPD technology, the μClamp0301PQ can effectively operate at 3.0V while maintaining excellent electrical characteristics.

The EPD TVS employs a complex nppn structure in contrast to the pn structure normally found in traditional silicon-avalanche TVS diodes. Since the EPD TVS devices use a 4-layer structure, they exhibit a slightly different IV characteristic curve when compared to conventional devices. During normal operation, the device represents a high-impedance to the circuit up to the device working voltage (VRWM). During an ESD event, the device will begin to conduct and will enter a low impedance state when the punch through voltage (VPT) is exceeded. Unlike a conventional device, the low voltage TVS will exhibit a slight negative resistance characteristic as it conducts current. This characteristic aids in lowering the clamping voltage of the device, but must be considered in applications where DC voltages are present.

When the TVS is conducting current, it will exhibit a slight “snap-back” or negative resistance characteristics due to its structures. This point is defined on the curve by the snap-back voltage (VSB) and snap-back current (ISB). To return to a non-conducting state, the current through the device must fall below the ISB (approximately <50mA)

Device Schematic & Pin Configuration

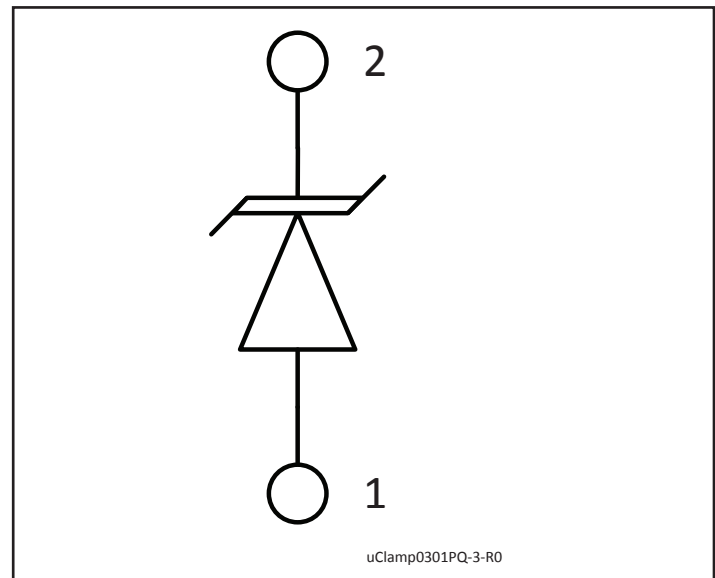

EPD TVS IV Characteristic Curve

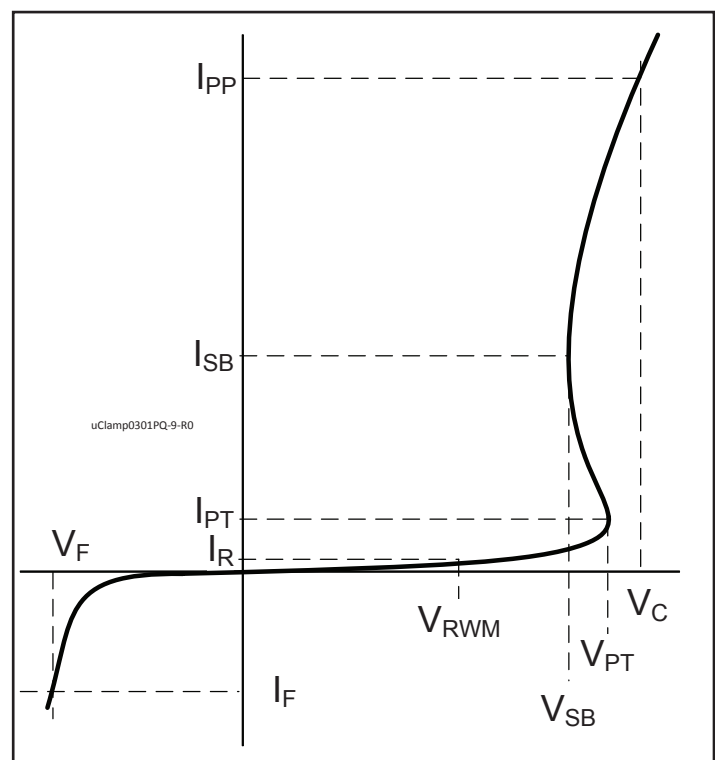

and the voltage must fall below the VSB (normally 2.8 volts for a 3.0V device). If a 3.0V TVS is connected directly to a 3.0V DC source, it will never fall below the snap-back voltage of 2.8V and will therefore stay in a conducting state.

PROTECTION PRODUCTS

Outline Drawing - SLP1006P2

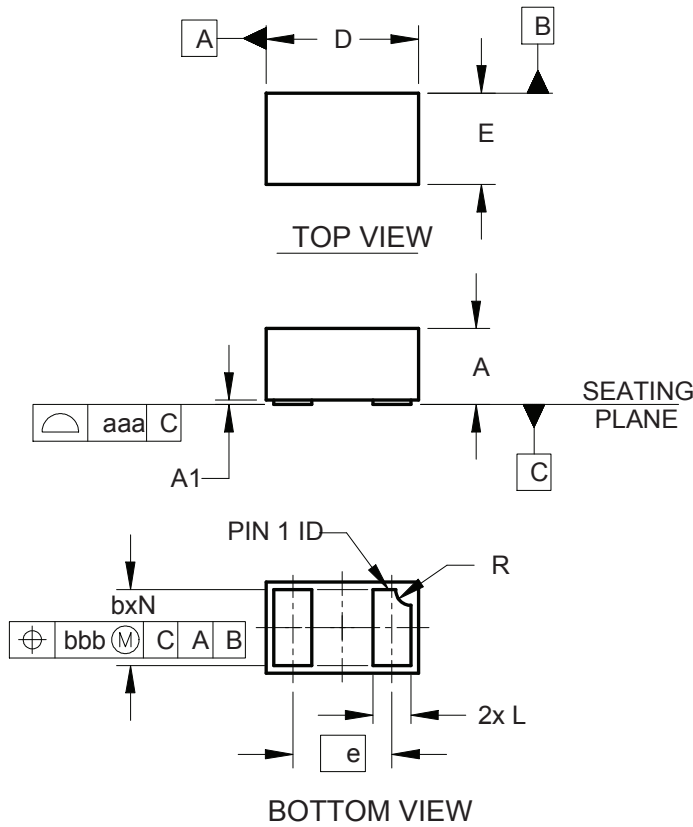

DIM	DIMENSIONS					
	INCHES			MILLIMETERS		
	MIN	NOM	MAX	MIN	NOM	MAX
A	.016	.020	.022	0.40	0.50	0.55
A1	.000	.001	.002	0.00	0.03	0.05
b	.018	.020	.022	0.45	0.50	0.55
D	.035	.039	.043	0.90	1.00	1.10
E	.020	.024	.028	0.50	0.60	0.70
e	.026 BSC			0.65 BSC		
L	.008	.010	.012	0.20	0.25	0.30
R	.002	.004	.006	0.05	0.10	0.15
N	2			2		
aaa	.003			0.08		
bbb	.004			0.10		

SLP1006P2-1-R0

NOTES:

1. CONTROLLING DIMENSIONS ARE IN MILLIMETERS (ANGLES IN DEGREES).

Land Pattern - SLP1006P2

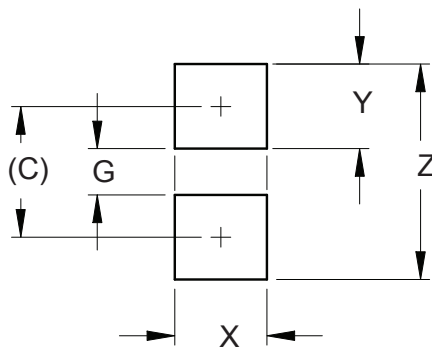

DIM	DIMENSIONS	
	INCHES	MILLIMETERS
C	(.033)	(0.85)
G	.012	0.30
X	.024	0.60
Y	.022	0.55
Z	.055	1.40

SLP1006P2-2-R0

NOTES:

1. CONTROLLING DIMENSIONS ARE IN MILLIMETERS (ANGLES IN DEGREES).
2. THIS LAND PATTERN IS FOR REFERENCE PURPOSES ONLY. CONSULT YOUR MANUFACTURING GROUP TO ENSURE YOUR COMPANY'S MANUFACTURING GUIDELINES ARE MET.

PROTECTION PRODUCTS

Marking

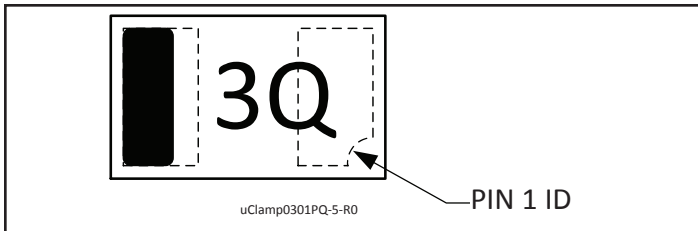

Notes: Cathode Band at Pin 2

Ordering Information

Part Number	Qty per Reel	Reel Size
μClamp0301PQTNT	10000	7"

Notes:

- 1) Lead finish is lead-free NiPdAu.
- 2) MicroClamp, uClamp and μClamp are trademarks of Semtech Corporation.

Tape and Reel Specification

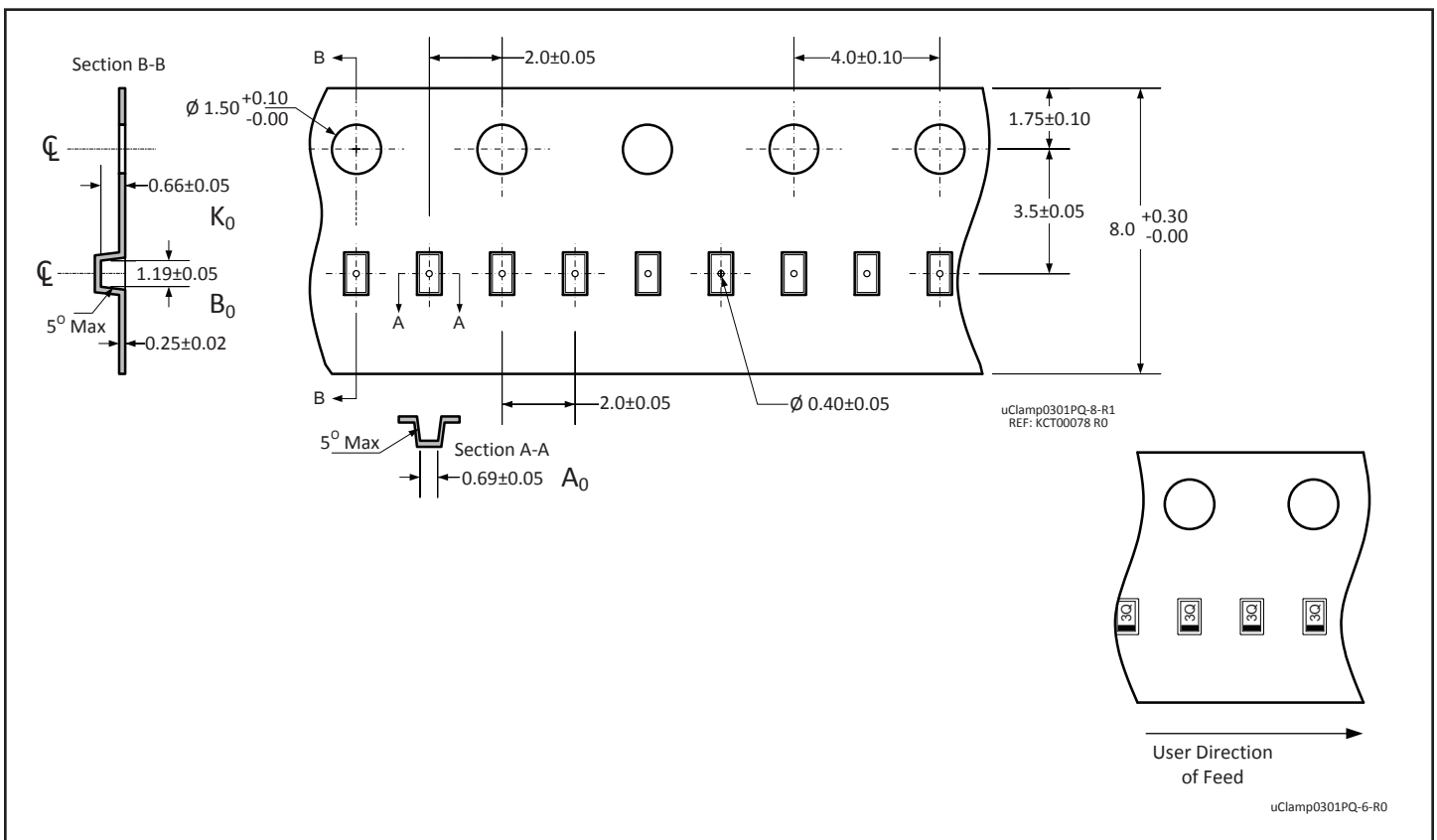

Contact Information

Semtech Corporation
 Protection Products Division
 200 Flynn Rd., Camarillo, CA 93012
 Phone: (805)498-2111 FAX (805)498-3804

X-ON Electronics

Largest Supplier of Electrical and Electronic Components

Click to view similar products for [ESD Suppressors / TVS Diodes](#) category:

Click to view products by [Semtech](#) manufacturer:

Other Similar products are found below :

[60KS200C](#) [D12V0H1U2WS-7](#) [D18V0L1B2LP-7B](#) [82356050220](#) [D5V0M5U6V-7](#) [NTE4902](#) [P4KE27CA](#) [P6KE11CA](#) [P6KE39CA-TP](#)
[P6KE8.2A](#) [SA110CA](#) [SA60CA](#) [SA64CA](#) [SMBJ12CATR](#) [SMBJ8.0A](#) [SMLJ30CA-TP](#) [ESD101-B1-02ELS E6327](#) [ESD112-B1-02EL E6327](#)
[ESD119B1W01005E6327XTSA1](#) [ESD5V0L1B02VH6327XTSA1](#) [ESD7451N2T5G](#) [19180-510](#) [CPDT-5V0USP-HF](#) [3.0SMCJ33CA-F](#)
[3.0SMCJ36A-F](#) [HSPC16701B02TP](#) [D3V3Q1B2DLP3-7](#) [D55V0M1B2WS-7](#) [DESD5V0U1BL-7B](#) [DRTR5V0U4SL-7](#) [SCM1293A-04SO](#)
[ESD200-B1-CSP0201 E6327](#) [ESD203-B1-02EL E6327](#) [SM12-7](#) [SMF8.0A-TP](#) [SMLJ45CA-TP](#) [CEN955 W/DATA](#) [82350120560](#)
[82356240030](#) [VESD12A1A-HD1-GS08](#) [CPDUR5V0R-HF](#) [CPDUR24V-HF](#) [CPDQC5V0U-HF](#) [CPDQC5V0USP-HF](#) [CPDQC5V0-HF](#)
[D1213A-01LP4-7B](#) [D1213A-02WL-7](#) [ESDLIN1524BJ-HQ](#) [5KP100A](#) [5KP15A](#)