

WTR06N300LS-HAF

N-Channel Enhancement Mode MOSFET

Features

- Low $R_{DS(ON)}$
- Halogen and Antimony Free(HAF), RoHS compliant

Applications

- Boost converters
- Synchronous rectifiers
- LED backlighting

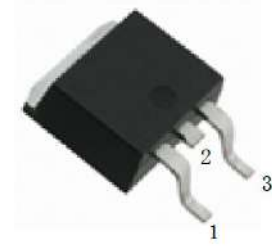
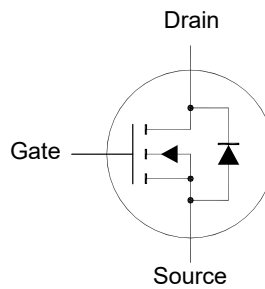

1.Gate 2.Drain 3.Source
TO-252 Plastic Package

Key Parameters

Parameter	Value	Unit
BV_{DSS}	60	V
$R_{DS(ON)}$ Max	34 @ $V_{GS} = 10$ V	m Ω
	38 @ $V_{GS} = 4.5$ V	
$V_{GS(th)}$ typ	1.5	V
Q_g typ	19 @ $V_{GS} = 10$ V	nC

Absolute Maximum Ratings (at $T_a = 25^\circ\text{C}$ unless otherwise specified)

Parameter	Symbol	Value	Unit
Drain-Source Voltage	V_{DS}	60	V
Gate-Source Voltage	V_{GS}	± 20	V
Continuous Drain Current	I_D	$T_c = 25^\circ\text{C}$	20
		$T_c = 100^\circ\text{C}$	13
Peak Drain Current,Pulsed ¹⁾	I_{DM}	50	A
Avalanche Current	I_{AS}	8.7	A
Single Pulse Avalanche Energy ²⁾	E_{AS}	3.7	mJ
Power Dissipation	P_D	25	W
Operating Junction and Storage Temperature Range	T_J, T_{stg}	- 55 to + 150	$^\circ\text{C}$

Thermal Characteristics

Parameter	Symbol	Max.	Unit
Thermal Resistance from Junction to Case	$R_{\theta JC}$	5	$^\circ\text{C/W}$
Thermal Resistance from Junction to Ambient ³⁾	$R_{\theta JA}$	50	$^\circ\text{C/W}$

¹⁾ Pulse Test: Pulse Width ≤ 100 μs , Duty Cycle $\leq 2\%$, Repetitive rating, pulse width limited by junction temperature $T_{J(MAX)} = 150^\circ\text{C}$.

²⁾ Limited by $T_{J(MAX)}$, starting $T_J = 25^\circ\text{C}$, $L = 0.1$ mH, $R_g = 25$ Ω , $I_{AS} = 8.7$ A, $V_{GS} = 10$ V.

³⁾ Device Surface Mounted on FR-4 substrate PC board, 2oz copper, with 1-inch square copper plate, in a still air.

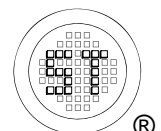

WTR06N300LS-HAF

Characteristics at $T_a = 25^\circ\text{C}$ unless otherwise specified

Parameter	Symbol	Min.	Typ.	Max.	Unit
STATIC PARAMETERS					
Drain-Source Breakdown Voltage at $I_D = 10\text{ mA}$	BV_{DSS}	60	-	-	V
Drain-Source Leakage Current at $V_{DS} = 48\text{ V}$	I_{DSS}	-	-	1	μA
Gate-Source Leakage Current at $V_{GS} = \pm 20\text{ V}$	I_{GSS}	-	-	± 100	nA
Gate-Source Threshold Voltage at $V_{DS} = V_{GS}$, $I_D = 250\text{ }\mu\text{A}$	V_{GSth}	1.2	-	2.5	V
Drain-Source On-State Resistance at $V_{GS} = 10\text{ V}$, $I_D = 15\text{ A}$ at $V_{GS} = 4.5\text{ V}$, $I_D = 10\text{ A}$	$R_{DS(on)}$	- -	26 -	34 38	$\text{m}\Omega$
DYNAMIC PARAMETERS					
Forward Transconductance at $V_{DS} = 5\text{ V}$, $I_D = 15\text{ A}$	g_{fs}	-	18	-	S
Gate Resistance at $V_{GS} = 0\text{ V}$, $V_{DS} = 0\text{ V}$, $f = 1\text{ MHz}$	R_g	-	0.8	-	Ω
Input Capacitance at $V_{GS} = 0\text{ V}$, $V_{DS} = 30\text{ V}$, $f = 1\text{ MHz}$	C_{iss}	-	1260	-	pF
Output Capacitance at $V_{GS} = 0\text{ V}$, $V_{DS} = 30\text{ V}$, $f = 1\text{ MHz}$	C_{oss}	-	47	-	pF
Reverse Transfer Capacitance at $V_{GS} = 0\text{ V}$, $V_{DS} = 30\text{ V}$, $f = 1\text{ MHz}$	C_{rss}	-	43	-	pF
Total Gate Charge at $V_{DS} = 30\text{ V}$, $V_{GS} = 10\text{ V}$, $I_D = 15\text{ A}$ at $V_{DS} = 30\text{ V}$, $V_{GS} = 4.5\text{ V}$, $I_D = 15\text{ A}$	Q_g	- -	19 8.7	- -	nC
Gate Source Charge at $V_{DS} = 30\text{ V}$, $V_{GS} = 10\text{ V}$, $I_D = 15\text{ A}$	Q_{gs}	-	4.3	-	nC
Gate Drain Charge at $V_{DS} = 30\text{ V}$, $V_{GS} = 10\text{ V}$, $I_D = 15\text{ A}$	Q_{gd}	-	2.6	-	nC
Turn-On Delay Time at $V_{DS} = 30\text{ V}$, $V_{GS} = 10\text{ V}$, $I_D = 15\text{ A}$, $R_g = 3.3\text{ }\Omega$	$t_{d(on)}$	-	11	-	ns
Turn-On Rise Time at $V_{DS} = 30\text{ V}$, $V_{GS} = 10\text{ V}$, $I_D = 15\text{ A}$, $R_g = 3.3\text{ }\Omega$	t_r	-	27	-	ns
Turn-Off Delay Time at $V_{DS} = 30\text{ V}$, $V_{GS} = 10\text{ V}$, $I_D = 15\text{ A}$, $R_g = 3.3\text{ }\Omega$	$t_{d(off)}$	-	10	-	ns
Turn-Off Fall Time at $V_{DS} = 30\text{ V}$, $V_{GS} = 10\text{ V}$, $I_D = 15\text{ A}$, $R_g = 3.3\text{ }\Omega$	t_f	-	2	-	ns
Body-Diode PARAMETERS					
Drain-Source Diode Forward Voltage at $I_S = 1\text{ A}$, $V_{GS} = 0\text{ V}$	V_{SD}	-	-	1.3	V
Body-Diode Continuous Current	I_S	-	-	20	A
Body-Diode Continuous Current, Pulsed	I_{SM}	-	-	50	A
Body Diode Reverse Recovery Time at $I_S = 15\text{ A}$, $di/dt = 100\text{ A}/\mu\text{s}$	t_{rr}	-	7.2	-	ns
Body Diode Reverse Recovery Charge at $I_S = 15\text{ A}$, $di/dt = 100\text{ A}/\mu\text{s}$	Q_{rr}	-	4.5	-	nC

Electrical Characteristics Curves

Fig. 1 Typical Output Characteristics

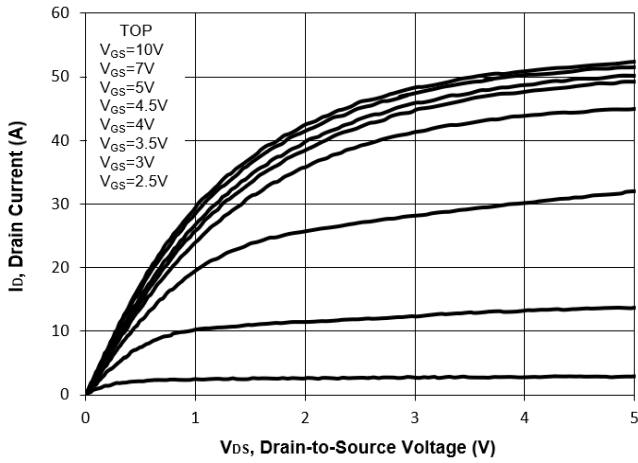

Fig. 3 On-Resistance vs. Drain Current

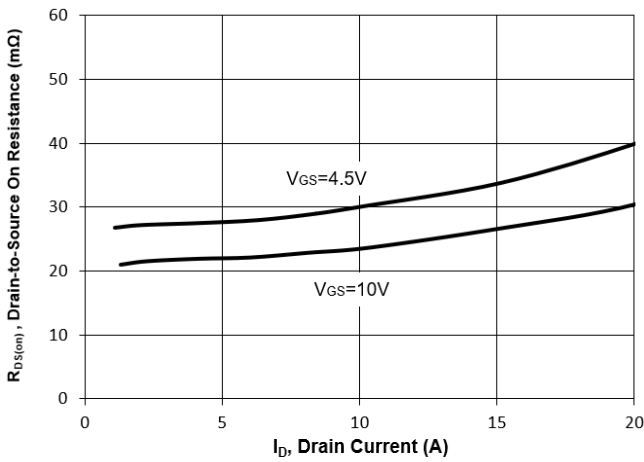

Fig. 5 On-Resistance vs. T_j

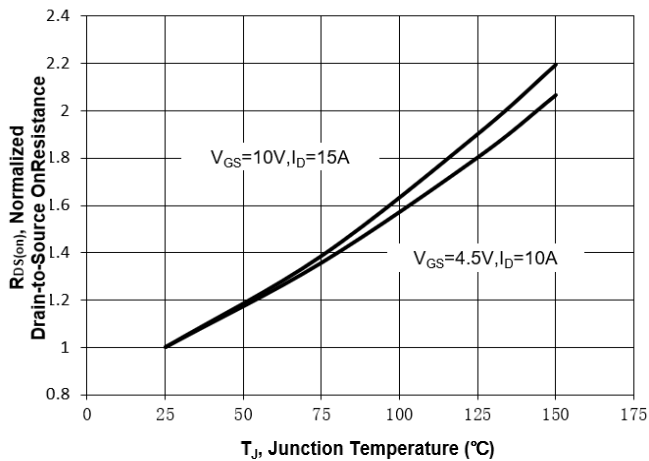

Fig. 2 Typical Transfer Characteristics

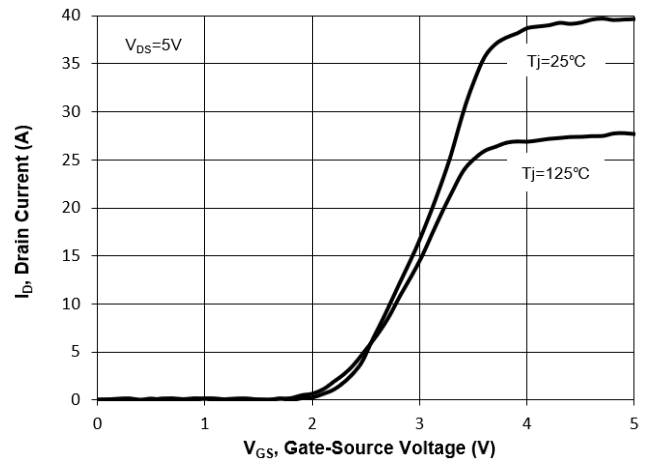

Fig. 4 On-Resistance vs. Gate to Source

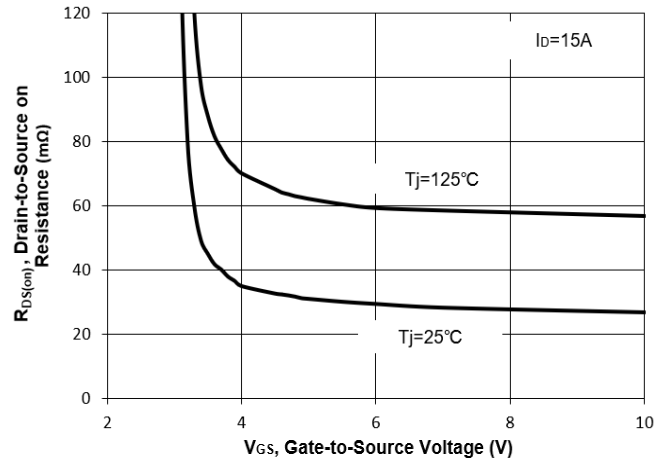
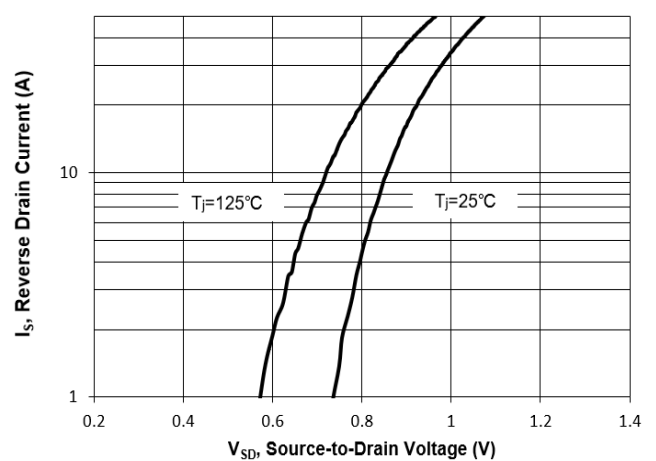

Fig. 6 Typical Body-Diode Forward Characteristics



Electrical Characteristics Curves

Fig. 7 Typical Junction Capacitance

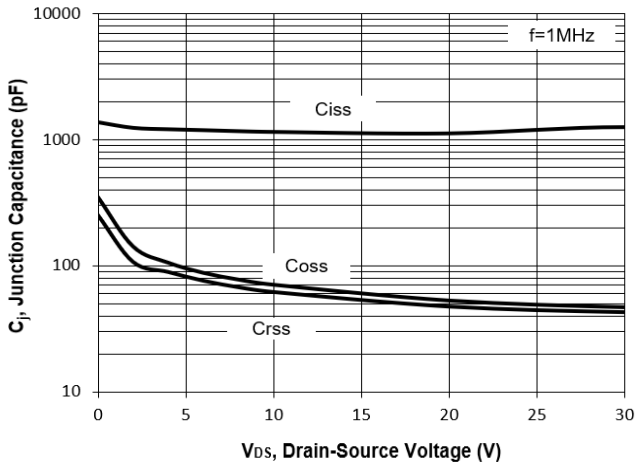

Fig. 8 Drain-Source Leakage Current vs. T_j

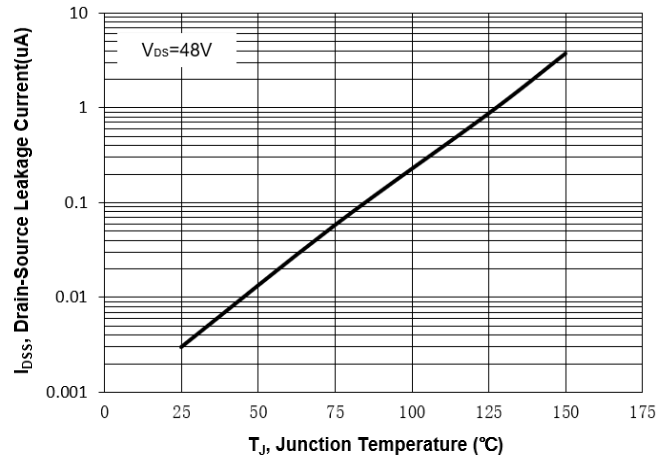

Fig. 9 $V_{(BR)DSS}$ vs. Junction Temperature

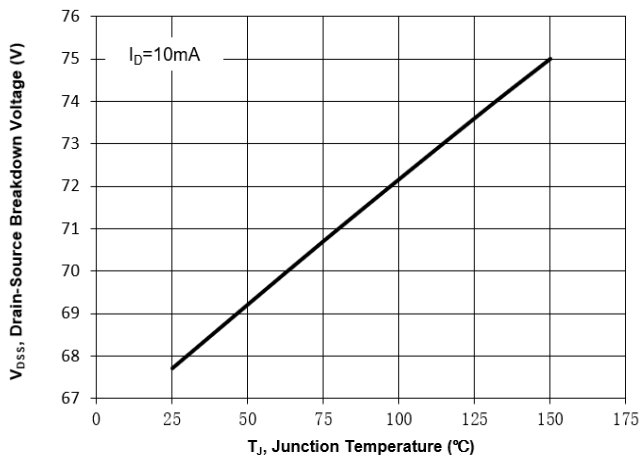

Fig. 10 Gate Threshold Variation vs. T_j

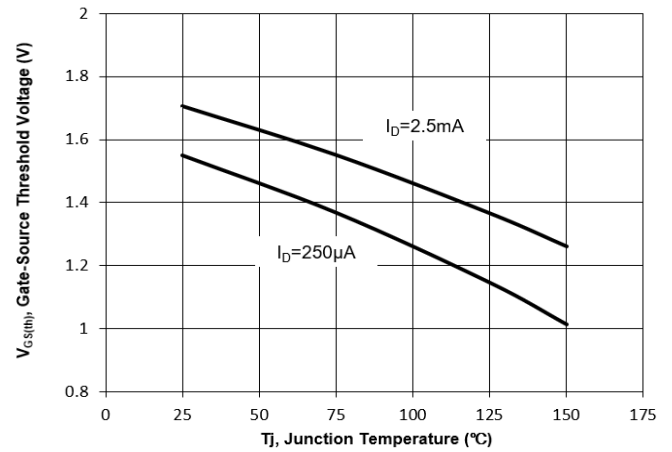

Fig. 11 Gate Charge

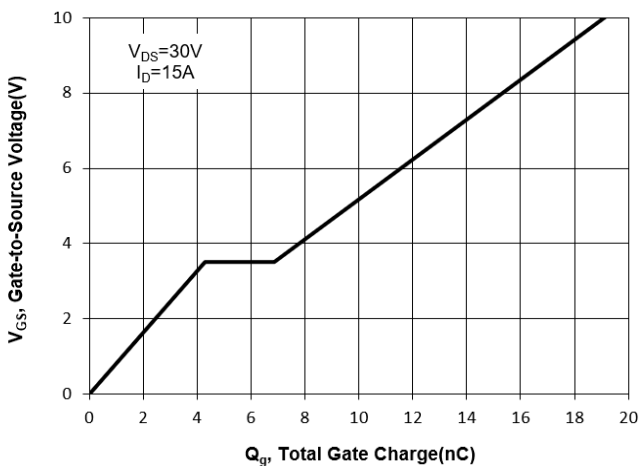
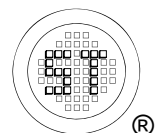
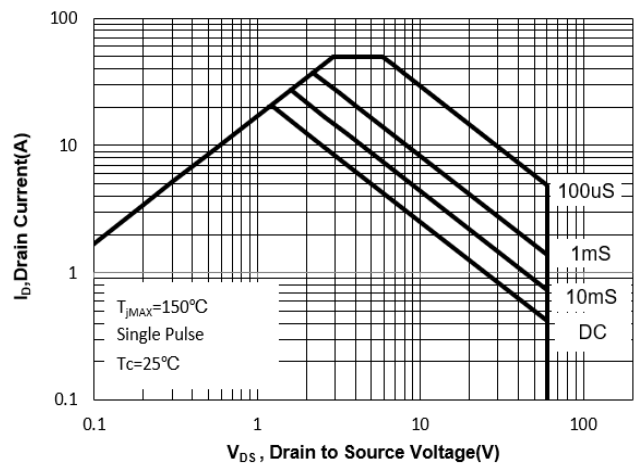

Fig. 12 Safe Operation Area



Electrical Characteristics Curves

Fig.13 Normalized Maximum Transient Thermal Impedance($Z_{\theta JC}$)

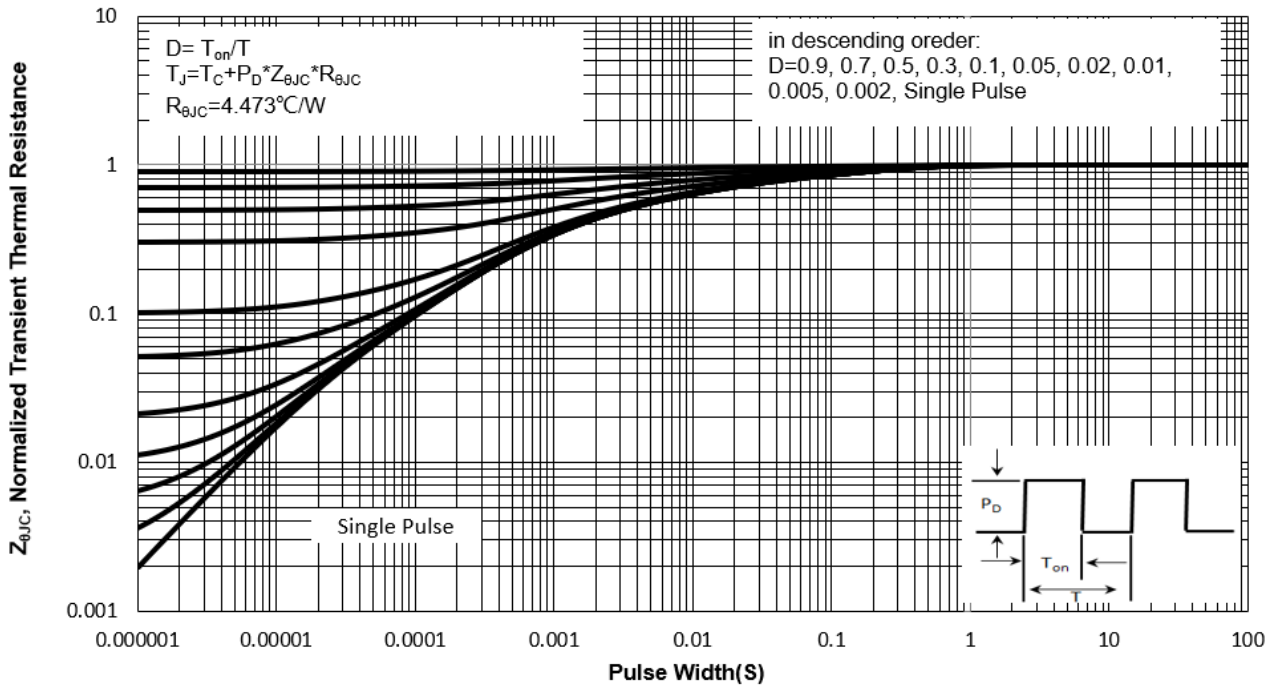
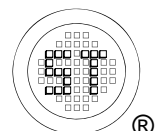
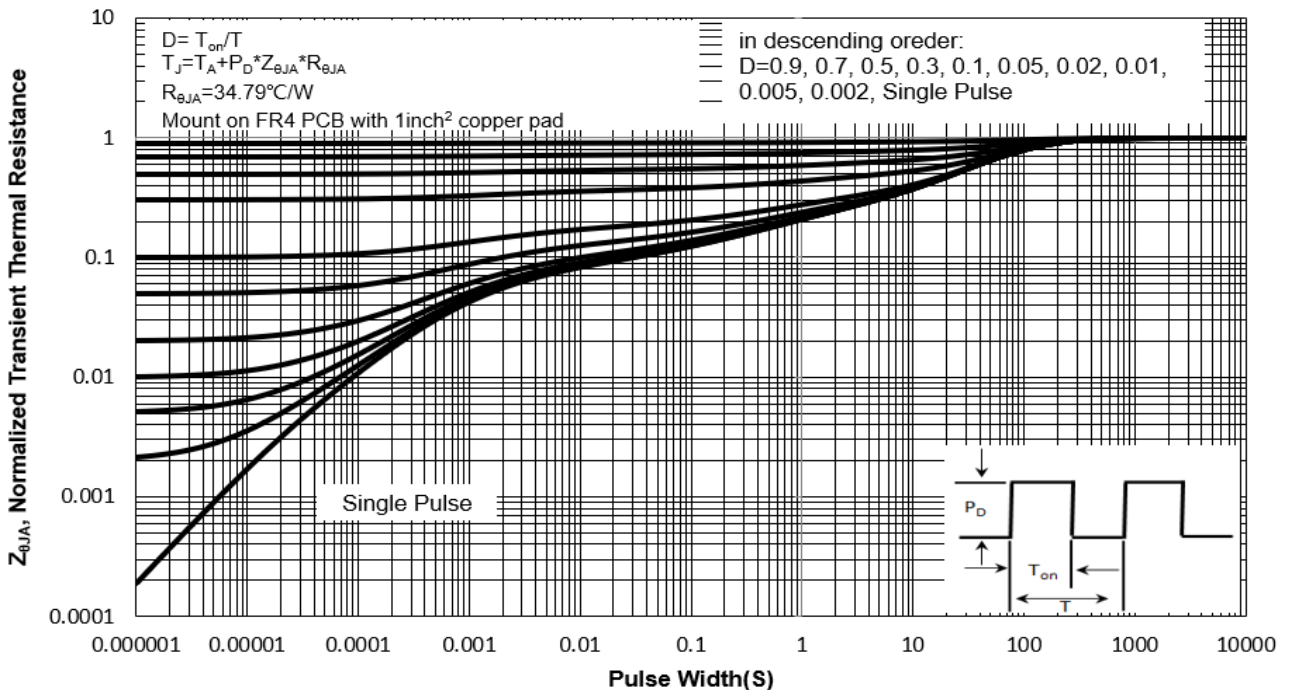

Fig.14 Normalized Maximum Transient Thermal Impedance($Z_{\theta JA}$)



Test Circuits

Fig.1-1 Switching times test circuit

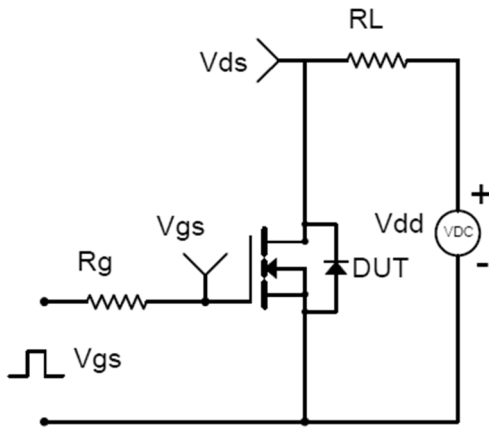

Fig.1-2 Switching Waveform

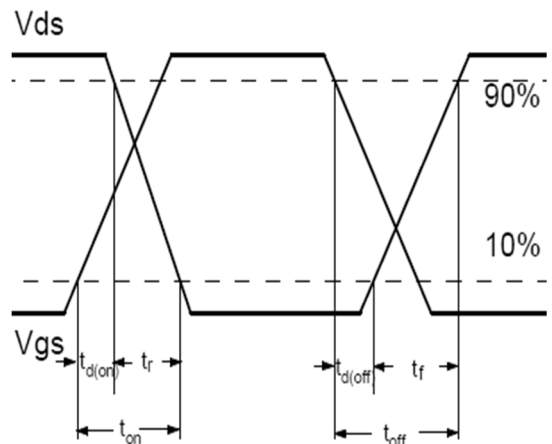

Fig.2-1 Gate charge test circuit

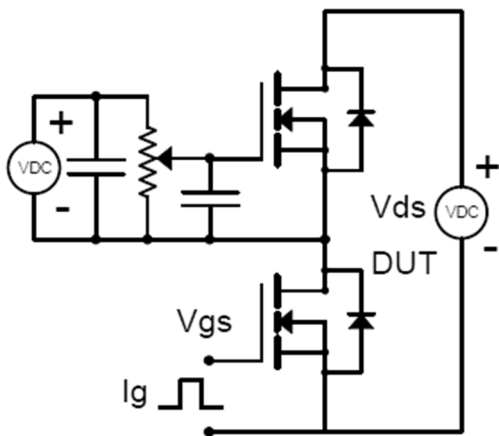

Fig.2-2 Gate charge waveform

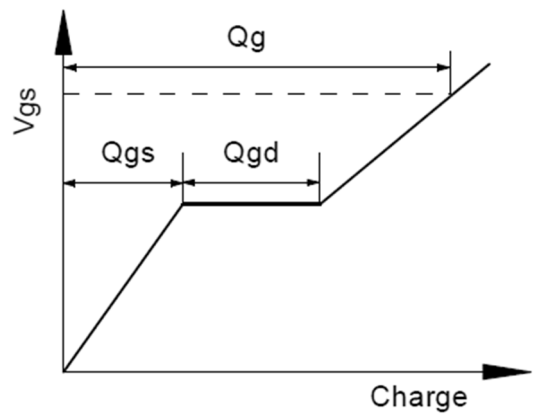

Fig.3-1 Avalanche test circuit

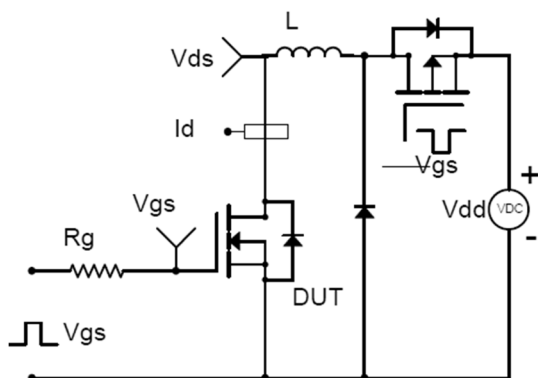
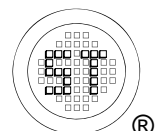
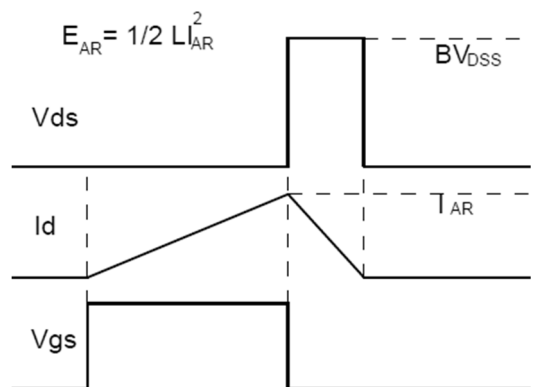

Fig.3-2 Avalanche waveform



WTR06N300LS-HAF

Package Outline (Dimensions in mm)

TO-252

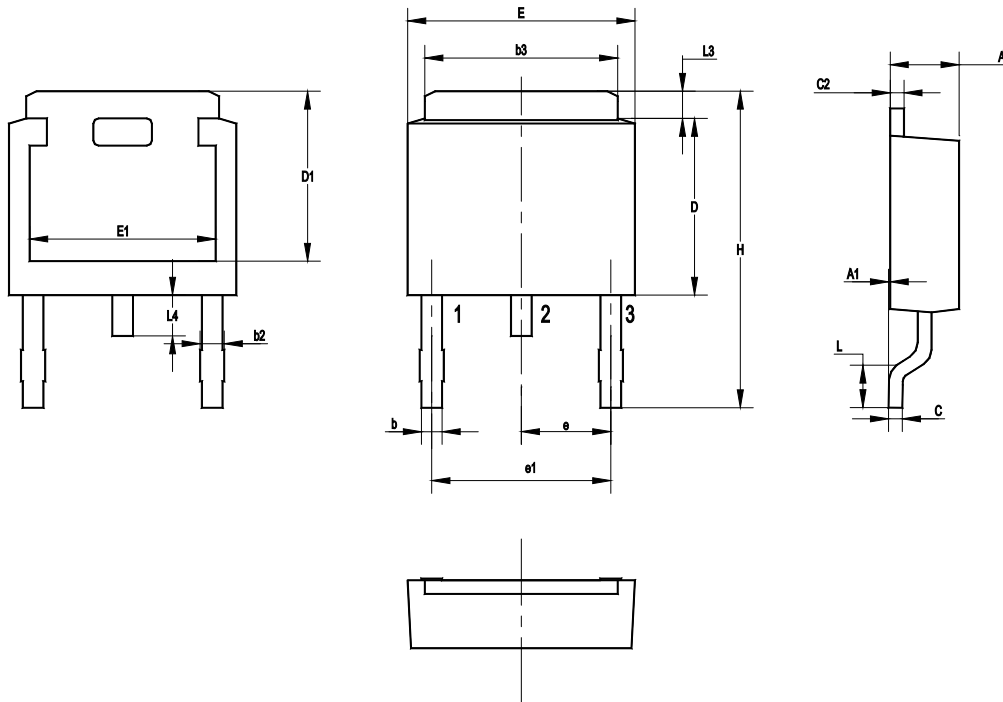

UNIT	A	A1	b	b2	b3	C	C2	D	D1	E	E1	e	e1	H	L	L3	L4
mm	2.5	0.15	1.0	1.15	5.5	0.65	0.65	6.2	5.4	6.7	5.0	2.30	4.60	10.7	1.78	1.20	1.10
	2.1	0	0.5	0.65	4.9	0.4	0.4	5.6	5.0	6.1	4.6	TYP.	TYP.	9	1.40	0.85	0.51

Recommended Soldering Footprint

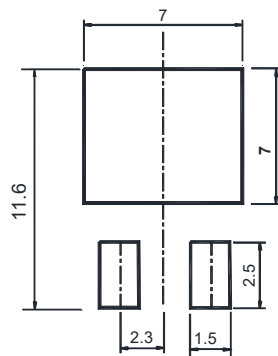

Packing information

Package	Tape Width (mm)	Pitch		Reel Size		Per Reel Packing Quantity
		mm	inch	mm	inch	
TO-252	16	8 ± 0.1	0.315 ± 0.004	330	13	2,500

Marking information

" TR06N300LS " = Part No.

" ***** " = Date Code Marking

Font type: Arial

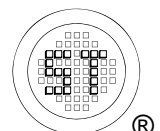

IMPORTANT NOTICE

Our company and its subsidiaries reserve the right to make modifications, enhancements, improvements, corrections or other changes to improve product design, functions and reliability without further notice to this document and any product described herein.

Statements described herein regarding the reliability and suitability of products is for illustrative purposes only. Products specifically described herein are not authorized for use as critical components in life support devices, automobile, military, aviation or aerospace only with the written approval of our company.

The information contained herein is presented only as guidance for product use. No license to any intellectual property rights is granted under this document. No responsibility is assumed by our company for any infringement of patents or any other intellectual property rights of third party that may result from the use of the product.

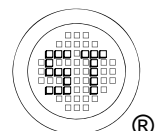

X-ON Electronics

Largest Supplier of Electrical and Electronic Components

Click to view similar products for [MOSFET](#) category:

Click to view products by [Semtech](#) manufacturer:

Other Similar products are found below :

[IRFD120](#) [JANTX2N5237](#) [2SK2267\(Q\)](#) [BUK455-60A/B](#) [TK100A10N1,S4X\(S](#) [MIC4420CM-TR](#) [VN1206L](#) [NDP4060](#) [SI4482DY](#)
[IRS2092STRPBF-EL](#) [IPS70R2K0CEAKMA1](#) [TK31J60W5,S1VQ\(O](#) [TK31J60W,S1VQ\(O](#) [TK16J60W,S1VQ\(O](#) [2SK2614\(TE16L1,Q\)](#)
[DMN1017UCP3-7](#) [EFC2J004NUZTDG](#) [P85W28HP2F-7071](#) [DMN1053UCP4-7](#) [NTE2384](#) [DMC2700UDMQ-7](#) [DMN2080UCB4-7](#)
[DMN61D9UWQ-13](#) [US6M2GTR](#) [DMN31D5UDJ-7](#) [DMP22D4UFO-7B](#) [IPS60R3K4CEAKMA1](#) [DMN1006UCA6-7](#) [DMN16M9UCA6-7](#)
[STF5N65M6](#) [IRF40H233XTMA1](#) [STU5N65M6](#) [DMN6022SSD-13](#) [DMN13M9UCA6-7](#) [DMTH10H4M6SPS-13](#) [IPS60R360PFD7SAKMA1](#)
[DMN2990UFB-7B](#) [SSM3K35CT,L3F](#) [IPLK60R1K0PFD7ATMA1](#) [2N7002W-G](#) [MCAC30N06Y-TP](#) [IPWS65R035CFD7AXKSA1](#)
[MCQ7328-TP](#) [SSM3J143TU,LXHF](#) [DMN12M3UCA6-7](#) [PJMF280N65E1_T0_00201](#) [PJMF380N65E1_T0_00201](#)
[PJMF280N60E1_T0_00201](#) [PJMF600N65E1_T0_00201](#) [PJMF900N65E1_T0_00201](#)