



## Power Plus DC Series

- Ratings from 10 A to 100 A @ 60 VDC
- LED Status Indicator
- Relays are easily paralleled for higher-current applications
- UL Approved, CE Compliant to EN60950-1
- Improved SEMS screw and washer
- Redesigned housing with anti-rotation barriers
- Mosfet Output
- DC control
- EMC Compliant to Level 3
- Epoxy Free Design
- Optional IP20 Cover
- PWM to 1K Hz

For **Generation 3** datasheet [click here](#)

### PRODUCT SELECTION

Control Voltage	10 A	20 A	40 A	60 A	80 A	100 A
4-32 VDC	DC60D10	DC60D20	DC60D40	DC60D60	DC60D80	DC60D100

### AVAILABLE OPTIONS

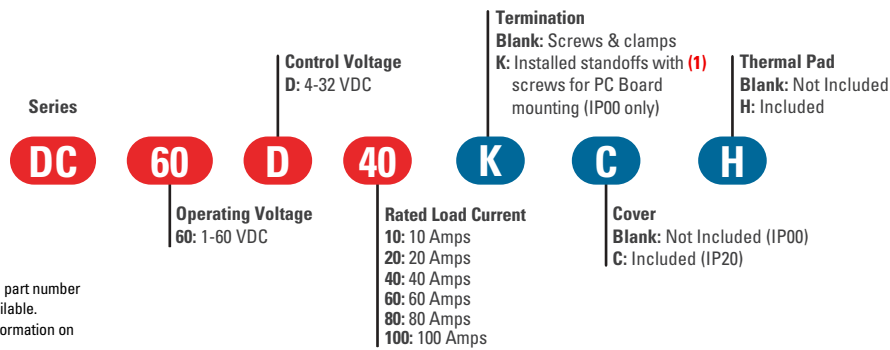

- Required for valid part number
  - For options only and not required for valid part number
  - \* Not all part number combinations are available.
- Contact Crydom Technical Support for information on the availability of a specific part number.

### OUTPUT SPECIFICATIONS <sup>(2)</sup>

Description	10 A	20 A	40 A	60 A	80 A	100 A
Recommended Operating Voltage [Vdc]	1-48	1-48	1-48	1-48	1-48	1-48
Absolute Maximing Rating [Vdc]	60	60	60	60	60	60
Maximum Off-State Leakage Current @ Rated Voltage [mA]	0.1	0.1	0.1	0.1	0.1	0.1
Maximum Load Current [Adc] (1)(3)	10	20	40	60	80	100
Minimum Load Current [mA] (4)	2.5	2.5	2.5	2.5	2.5	2.5
Maximum Surge Current (10msec) [Adc]	78	108	163	200	258	326
Maximum On-State Voltage Drop @ Rated Current [Vdc]	0.17	0.30	0.36	0.51	0.46	0.56
Maximum On-State Resistance [RDS-ON] [mΩ]	17	15	9	8.5	5.8	5.6
Thermal Resistance Junction to Case [Rjc] [°C/W]	1.6	1.6	0.74	0.74	0.51	0.51
Minimum Heat Sink for Rated Current @ 40°C [°C/W]	5	5	2	1	0.5	0.5
Maximum Pulse Width Modulation Frequency [Hz] (5)	1000	1000	900	900	700	700

### INPUT SPECIFICATIONS <sup>(2)</sup>

Description	DC Control
Control Voltage Range	4-32 VDC
Maximum Reverse Voltage	-32 VDC
Minimum Turn-On Voltage (6)	4 VDC
Must Turn-Off Voltage	1 VDC
Minimum Input Current (for on-state)	11 mA
Maximum Input Current	14 mA
Nominal Input Impedance	Current Regulated
Maximum Turn-On Time [µsec]	75
Maximum Turn-Off Time [µsec]	150

**GENERAL SPECIFICATIONS (2)**

Description	Parameters
Dielectric Strength, Input/Output/Base (50/60Hz)	3750 Vrms
Minimum Insulation Resistance (@ 500 VDC)	10 <sup>9</sup> Ohms
Maximum Capacitance, Input/Output	8 pF
Ambient Operating Temperature Range (7)	-40 to 100 °C
Ambient Storage Temperature Range	-40 to 125 °C
Weight (typical)	2.53 oz (72 g)
Housing Material	UL94 V-0
Hardware Finish	Nickel Plating
Baseplate Material	Aluminum
Input Terminal Screw Torque Range (in-lb/Nm)	13-15 / 1.5-1.7
Load Terminal Screw Torque Range (in-lb/Nm)	18-20 / 2-2.2
SSR Mounting Screw Torque Range (in-lb/Nm)	18-20 / 2-2.2
Input/Load Terminal Screw Torque Range (in-lb/Nm) (1)	w/"K" option 8-10 / 0.9-1.13
Input/Output Terminal Screw Thread Size	#6-32 UNC / #8-32 UNC
Humidity per IEC60068-2-78	93% non-condensing
LED Input Status Indicator	Green
MTBF (Mean Time Between Failures) at 40°C ambient temperature (8)	21,395,130 hours (2,441 years)
MTBF (Mean Time Between Failures) at 60°C ambient temperature (8)	11,545,504 hours (1,317 years)

**WIRING DIAGRAM**

\* Inductive loads must be diode suppressed.

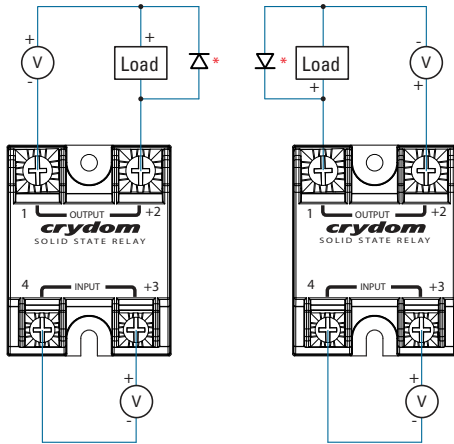

Recommended Wire Sizes		
Terminals	Wire Size (Solid / Stranded)	Wire Pull-Out Strength (lb)[N]
Input	24 AWG (0.2 mm <sup>2</sup> ) / 0.2 [minimum]	10 [44.5]
	2 x 12 AWG (3.3 mm <sup>2</sup> ) / 3.3 [maximum]	90 [400]
Output	20 AWG (0.5 mm <sup>2</sup> ) / 0.518 [minimum]	30 [133]
	2 x 10 AWG (5.3 mm <sup>2</sup> ) / 5.3 [maximum]	110 [490]
	2 x 8 AWG (8.4 mm <sup>2</sup> ) / 8.4 [maximum]	90 [400]

**EQUIVALENT CIRCUIT BLOCK DIAGRAMS**

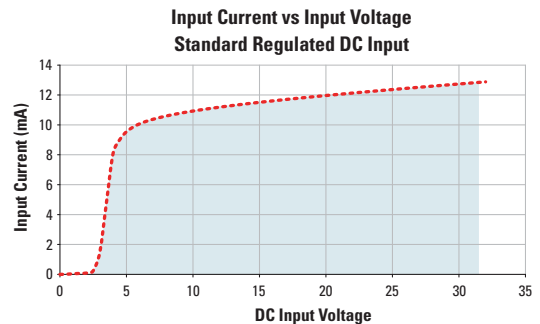
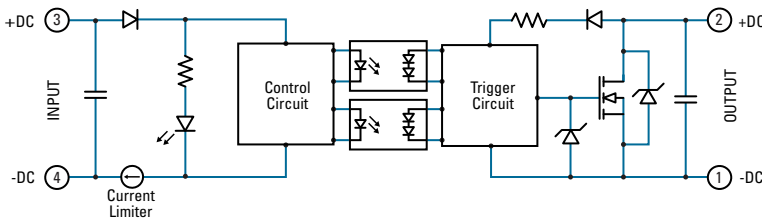

**MECHANICAL SPECIFICATIONS (2)**

Tolerances: ±0.02 in / 0.5 mm  
 All dimensions are in: inches [millimeters]

**Screw Termination**

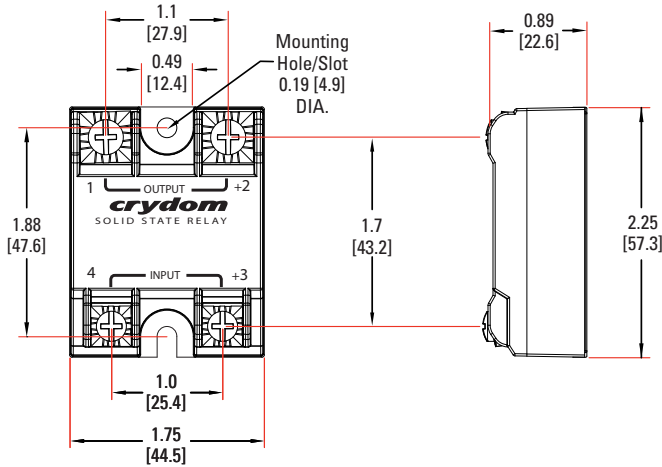

**Hex Standoff Termination ("K" Option) (1)**

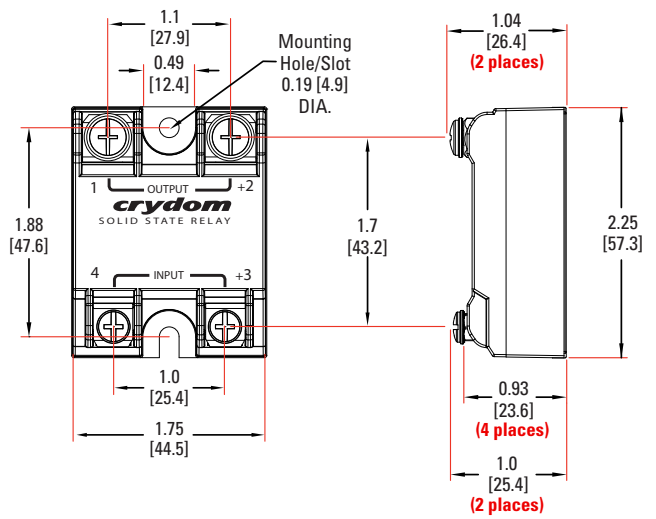

**Screw Termination, IP20**

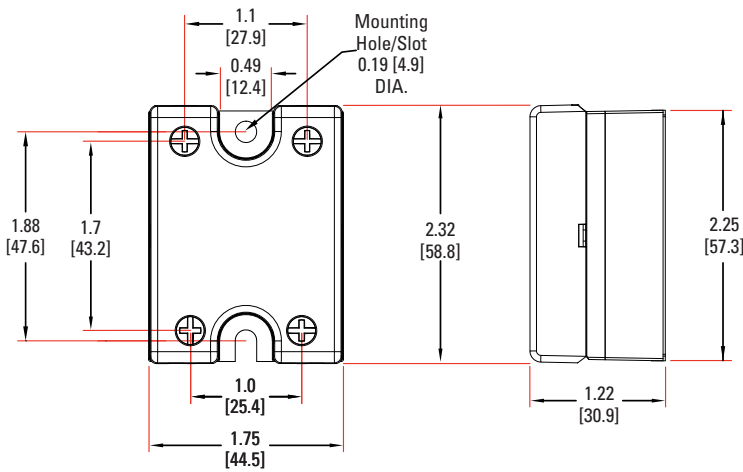

**GENERAL NOTES**

- (1) Option "K" is designed and tested for use with printed circuit boards or ring/fork terminals having a thickness between 0.031 and 0.093 inches (0.79 to 2.36 mm), and loads rated up to 50 Amps. For higher load currents, the "K" standoff temperature must not exceed 105°C. For additional application assistance please contact Crydom Technical Support.
- (2) All parameters at Tc=25°C unless otherwise specified.
- (3) Heat sinking required, see derating curves.
- (4) Low current loads and high ambient temperature can affect turn-on time.
- (5) 8VDC minimum control voltage. Resistive loads only. Consider switching losses; at maximum frequency reduce to 75% output current.
- (6) Increase minimum voltage by 1V for operations from -20 to -40°C.
- (7) Decrease maximum control voltage 1.35V/°C above 80°C ambient temperature.
- (8) All parameters at 50% power rating and 100% duty cycle (contact Crydom tech support for detailed report).

For additional information or specific questions, contact Crydom Technical Support.

**SURGE CURRENT INFORMATION**

--- Single Pulse (i) — Duty Factor (10%) (ii) - - - Duty Factor (20%) (ii) - - - Duty Factor (50%) (ii)

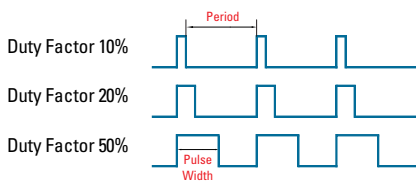
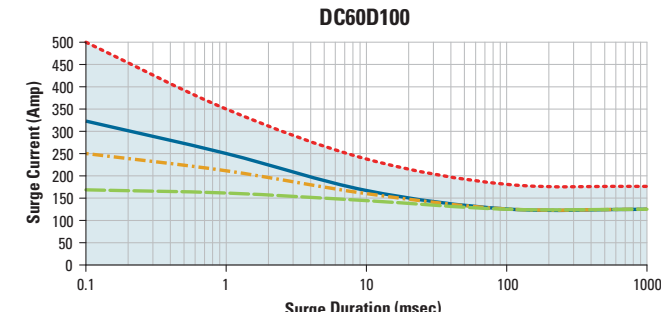
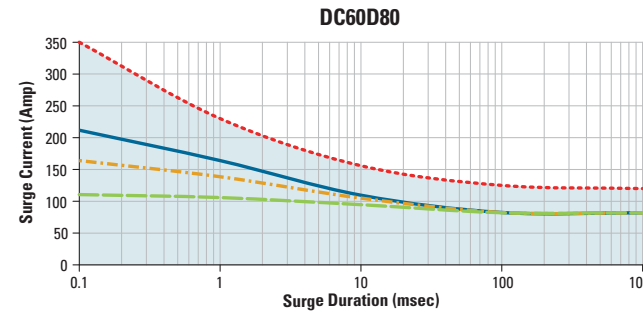
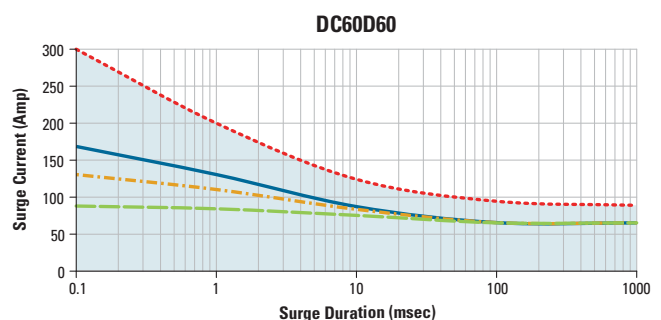
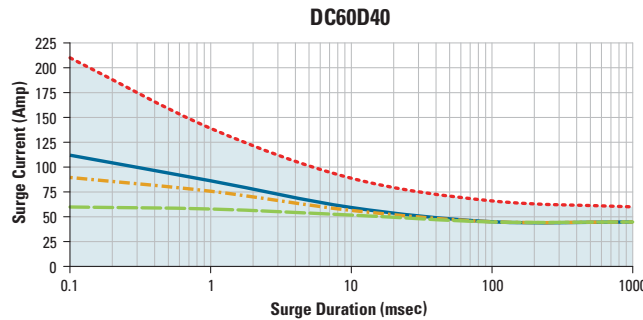
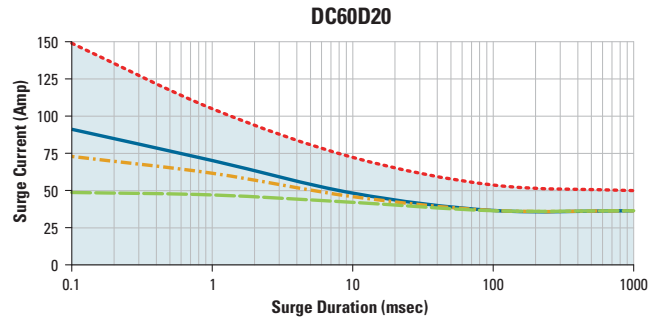
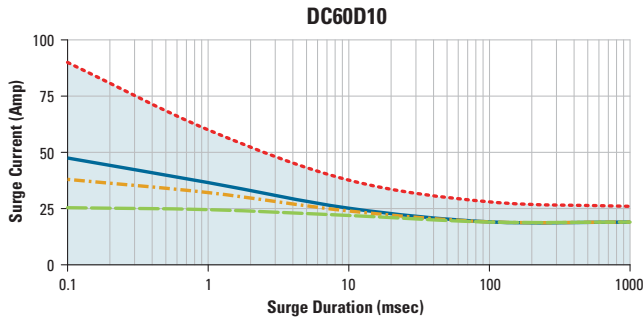

For Pulse Width Modulation applications select the curve according duty factor and pulse duration as following.

$$\text{Duty Factor} = \frac{\text{Pulse Width}}{\text{Period}} \times 100 (\%)$$

- (i) for Single Surge Pulse  $T_c=40^\circ\text{C}; T_j 175^\circ\text{C}$
- (ii) for Repetitive Surge Pulse  $T_c=40^\circ\text{C}; T_j 130^\circ\text{C}$

**THERMAL DERATE INFORMATION**

(iii) SSR metal base plate acting as heat sink, it must be exposed to free ambient air.

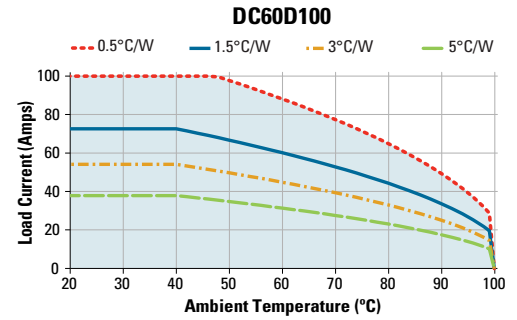
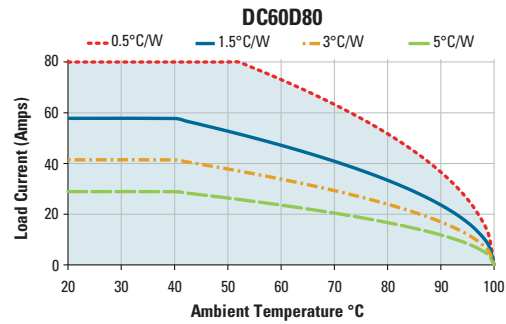
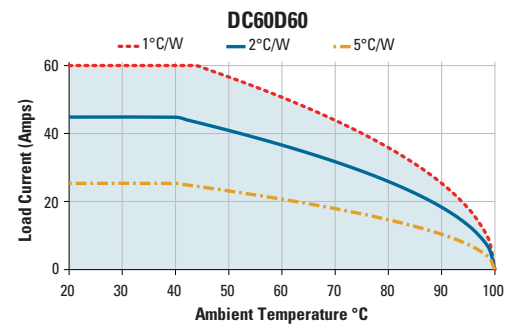
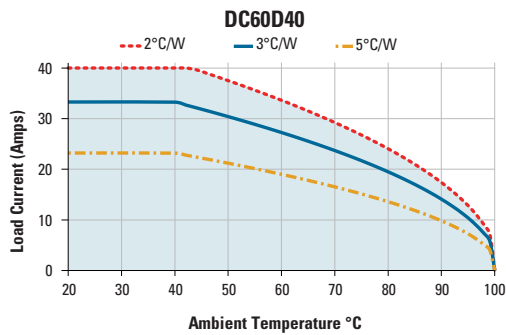
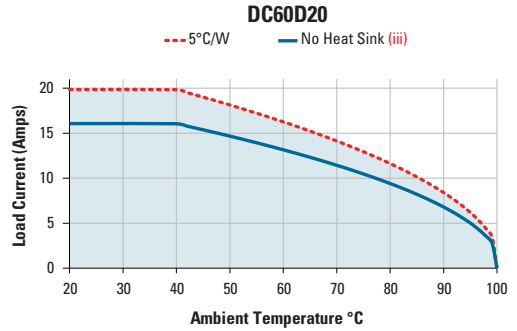
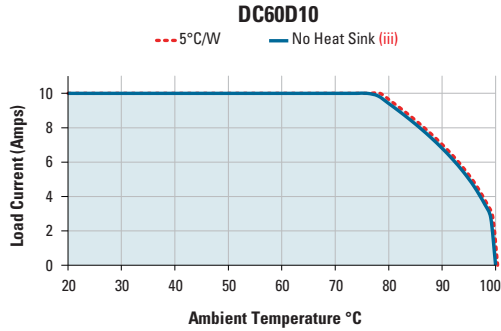

**AGENCY APPROVALS**

**Agency Approvals**

EN60950-1: Meets the requirements of sections 1.5: 1.7: 2.9: 2.10.5.3: 4.2: 4.5: 4.7:  
 IEC 61000-4-2 Electrostatic Discharge Level 3  
 IEC 61000-4-4 Electrically Fast Transients Level 3  
 IEC 61000-4-5 Electrical Surges Level 3  
 Vibration Resistance: IEC 60068-2-6 : Amplitude Range 10-55 Hz, Displacement 0.75mm  
 Shock Resistance: IEC 60068-2-27 : Peak Acceleration 15g, Duration 11msec

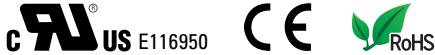

**ACCESSORIES**

**New Accessories!**  
**Protective Cover & Hardware Kits**

**Protective Cover**

Part number: KS101

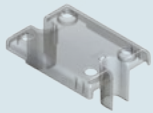

Clear plastic cover compatible with all new S1 designs. Safety covers provide added protection from electric shock when installing or checking equipment.





**Hardware Kit**

Part number: HK4



Bag with 2 square brass accessories and 2 screw 8-32 x 5/8 for output. Used to mount TMR1 lug terminals.

**Recommended Accessories**

 <b>Cover</b>	 <b>Hardware Kit</b>	 <b>Heat Sink Part No.</b>	<b>Thermal Resistance [°C/W]</b>	 <b>Lug Terminal</b>	 <b>Thermal Pad</b>
KS101	HK1	HS501DR	5.0	TRM1	HSP-1
	HK4	HS301 / HS301DR	3.0	TRM6	HSP-2
		HS251	2.5		
		HS201 / HS201DR	2.0		
		HS202 / HS202DR	2.0		
		HS172	1.7		
		HS151 / HS151DR	1.5		
		HS122 / HS122DR	1.2		
		HS103 / HS103DR	1.0		
		HS101	1.0		
		HS073	0.7		
		HS072	0.7		
		HS053	0.5		
		HS033	0.36		
HS023	0.25				

Rev. 100520  
 ECN#20981

**⚠ DANGER / PELIGRO / DANGER /GEFAHR / PERICOLO / 危險**

<p><b>HAZARD OF ELECTRIC SHOCK, EXPLOSION, OR ARC FLASH.</b></p> <ul style="list-style-type: none"> <li>• Disconnect all power before installing or working with this equipment.</li> <li>• Verify all connections and replace all covers before turning on power.</li> </ul> <p><b>Failure to follow these instructions will result in death or serious injury.</b></p>	<p><b>RIESGO DE DESCARGA ELECTRICA O EXPLOSION.</b></p> <ul style="list-style-type: none"> <li>• Desconectar todos los suministros de energia a este equipo antes de trabajar con este equipo.</li> <li>• Verificar todas las conexiones y colocar todas las tapas antes de energizar el equipo.</li> </ul> <p><b>El incumplimiento de estas instrucciones puede provocar la muerte o lesiones serias.</b></p>	<p><b>RISQUE DE DESCARGE ELECTRIQUE OU EXPLOSION</b></p> <ul style="list-style-type: none"> <li>• Eteindre toutes les sources d'énergie de cet appareil avant de travailler dessus de cet appareil</li> <li>• Vérifier tous connections, et remettre tous couverts en olace avant de mettre sous</li> </ul> <p><b>De non-suivi de ces instructions provoquera la mort ou des lésions sérieuses.</b></p>	<p><b>GEFAHR EINES ELEKTRISCHE N SCHLAGES ODER EINER EXPLOSION.</b></p> <ul style="list-style-type: none"> <li>• Stellen Sie jeglichen Strom ab, der dieses Gerät versorgt, bevor Sie an dem Gerät Arbeiten durchführen</li> <li>• Vor dem Drehen auf Energie alle Anschlüsse überprüfen und alle Abdeckungen ersetzen.</li> </ul> <p><b>Unterlassung dieser Anweisungen können zum Tode oder zu schweren Verletzungen führen.</b></p>	<p><b>RISCHIO DI SCOSSA ELETTRICA O DELL'ESPLOSIONE.</b></p> <ul style="list-style-type: none"> <li>• Spenga tutta l'alimentazione che fornisce questa apparecchiatura prima di lavorare a questa apparecchiatura</li> <li>• Verificare tutti i collegamenti e sostituire tutte le coperture prima dell'accensione</li> </ul> <p><b>L'omissione di queste istruzioni provocherà la morte o lesioni serie</b></p>	<p><b>存在电击、爆炸或电弧闪烁危险</b></p> <ul style="list-style-type: none"> <li>• 在操作此设备之前请先关闭电源。</li> </ul> <p><b>若不遵守这些说明,可能会导致严重的人身伤害甚至死亡。</b></p>
--	--	---	--	--	---

**⚠ WARNING / AVERTISSEMENT / WARNUNG /ADVERTENCIA / AVVERTENZA / 警告**

<p><b>RISK OF MATERIAL DAMAGE AND HOT ENCLOSURE</b></p> <ul style="list-style-type: none"> <li>• The product's side panels may be hot, allow the product to cool before touching.</li> <li>• Follow proper mounting instructions including torque values.</li> <li>• Do not allow liquids or foreign objects to enter this product.</li> </ul> <p><b>Failure to follow these instructions can result in serious injury, or equipment damage.</b></p>	<p><b>RISQUE DE DOMMAGE MATERIEL ET DE SURCHAUFFE DU BOITIER</b></p> <ul style="list-style-type: none"> <li>• Les panneaux latéraux du produit peuvent être chauds. Laisser le produit refroidir avant de le toucher.</li> <li>• Respecter les consignes de montage, et notamment les couples de serrage.</li> <li>• Ne pas laisser pénétrer de liquide ni de corps étrangers à l'intérieur du produit.</li> </ul> <p><b>Le non-respect de cette directive peut entraîner, des lésions corporelles graves ou des dommages matériels.</b></p>	<p><b>GEFAHR VON MATERIALSCHÄDEN UND GEHÄUSEERHITZUNG</b></p> <ul style="list-style-type: none"> <li>• Die Seitenwände können heiß sein. Lassen Sie das Produkt abkühlen, bevor Sie es berühren.</li> <li>• Beachten Sie die Montageanweisungen,</li> <li>• Führen Sie keine Flüssigkeiten oder Fremdkörper in das Produkt ein.</li> </ul> <p><b>Die Nichtbeachtung dieser Anweisung kann Körperverletzung oder Materialschäden zur Folge haben.</b></p>
<p><b>RIESGO DE DAÑOS MATERIALES Y DE SOBRECALENTAMIENTO DE LA UNIDAD</b></p> <ul style="list-style-type: none"> <li>• Los paneles laterales del producto pueden estar calientes. Esperar que el producto se enfríe antes de tocarlo.</li> <li>• Respetar las instrucciones de montaje, y en particular los pares de apretado.</li> <li>• No dejar que penetren líquidos o cuerpos extraños en el producto.</li> </ul> <p><b>Si no se respetan estas precauciones pueden producirse graves lesiones, daños materiales.</b></p>	<p><b>RISCHIO DI DANNI MATERIALI E D'INVOLUCRO CALDO</b></p> <ul style="list-style-type: none"> <li>• I pannelli laterali dell'apparecchio possono scottare; lasciar quindi raffreddare il prodotto prima di toccarlo.</li> <li>• Seguire le istruzioni di montaggio corrette.</li> <li>• Non far entrare liquidi o oggetti estranei in questo apparecchio.</li> </ul> <p><b>La mancata osservanza di questa precauzione può causare gravi rischi per l'incolumità personale o danni alle apparecchiature.</b></p>	<p><b>材料损坏和高温外壳的危险性</b></p> <ul style="list-style-type: none"> <li>• 产品的一侧面板可能很热, 在其冷却前请不要触碰。</li> <li>• 遵照正确的安装说明, 包括扭矩值。</li> <li>• 请勿让液体及其他异物进入本产品。</li> </ul> <p><b>如不能正确执行这些操作说明, 极有可能造成严重人体伤害或者设备的损坏。</b></p>

**ANNEX - ENVIROMENTAL INFORMATION**

The environmental information disclosed in this annex including the EIP Pollution logo are in compliance with People’s Republic of China Electronic Industry Standard SJ/T11364 – 2006, Marking for Control of Pollution Caused by Electronic Information Products.

Part Name	Toxic or hazardous Substance and Elements					
	Lead (Pb)	Mercury (Hg)	Cadmium (Cd)	Hexavalent Chromium (Cr (VI))	Polybrominated biphenyls (PBB)	Polybrominated diphenyl ethers (PBDE)
Semiconductor die	X	○	○	○	○	○
Solder	X	○	○	○	○	○

**附件 - 环保信息**

此附件所标示的包括电子信息产品污染图标的环保信息符合中华人民共和国电子行业标准 SJ/T11364 - 2006, 电子信息产品污染控制标识要求。

部件名称	有毒有害物质或元素					
	铅 (Pb)	汞 (Hg)	镉 (Cd)	六价铬 (Cr (VI))	多溴联苯 (PBB)	多溴二苯醚 (PBDE)
半导体芯片	X	○	○	○	○	○
焊接点	X	○	○	○	○	○





## X-ON Electronics

Largest Supplier of Electrical and Electronic Components

*Click to view similar products for [Solid State Relays - Industrial Mount](#) category:*

*Click to view products by [Sensata](#) manufacturer:*

Other Similar products are found below :

[D2440-C](#) [H10CA4890](#) [D4875C](#) [1395831-1](#) [1616010-6](#) [BR312BY](#) [A-1326](#) [H10CA4850](#) [H12CA4890VL](#) [RA2410-D06](#) [RA2410HA06T](#)  
[D1202F](#) [D53TP50-10](#) [W230E-1-12](#) [W230T-3-12](#) [1-1617030-3](#) [1-1617033-7](#) [MS2-D2420](#) [MS2-D2430](#) [A-1440](#) [RJ1P60V50E](#) [HS501DR-](#)  
[D2425](#) [RN1F48I50](#) [70.362.1028.0](#) [7-1393030-8](#) [Z5.509.0828.0](#) [G3DZ-4B DC24](#) [G3DZ-F4B DC12](#) [2912138](#) [SSRDAC10](#) [SSR-10048RD1](#)  
[RV8S-L-A240-D24](#) [RV8S-L-A240-D6](#) [RV8S-S-A240-D6](#) [RV8S-S-A240Z-D24](#) [RV8S-S-D24-A240](#) [RV8S-S-D48-A120](#) [RN1F12V50](#)  
[RJ1P60I30E](#) [RJ1P60V30E](#) [SO967860](#) [SMT8628521](#) [SO869970](#) [SOD867180](#) [SOM040100](#) [SAL961360](#) [SO867970](#) [SOB863860](#)  
[SOB867640](#) [G3PH-5150B DC5-24](#)