



## EL Series

### DC Output Panel Mount SSRs

- Ratings of 5A and 10A @ 3-100 VDC
- UL Recognized, TUV, CE and RoHS Compliant
- 5, 12 and 24 VDC control input options
- Mosfet Output
- Thermal Pad Included

### PRODUCT SELECTION

Control Voltage	5A	10A
4-8 VDC	EL100D5-05	EL100D10-05
10-14 VDC	EL100D5-12	EL100D10-12
21-27 VDC	EL100D5-24	EL100D10-24

### AVAILABLE OPTIONS

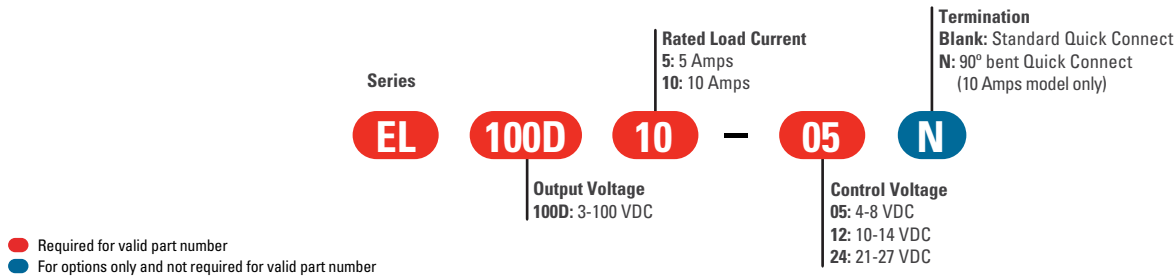

### OUTPUT SPECIFICATIONS <sup>(1)(3)</sup>

Description	5A	10A
Operating Voltage [VDC]	3-100	3-100
Maximum Load Current [Adc] <sup>(2)</sup>	5	10
Minimum Load Current [mAdc]	20	20
Maximum Surge Current Non-Repetitive (10ms) [A]	80	100
Maximum Off-State Leakage Current @ Rated Voltage [ $\mu$ Adc]	100	100
Maximum On-State Resistance @ Rated Current (Rds-on) [Ohm]	0.02	0.02
Maximum On-State Voltage Drop @ Rated Current [VDC]	0.12	0.25

### INPUT SPECIFICATIONS <sup>(1)</sup>

Description	EL100Dxx-05	EL100Dxx-12	EL100Dxx-24
Control Voltage Range	4-8 VDC	10-14 VDC	21-27 VDC
Minimum Turn-On Voltage	4 VDC	10 VDC	21 VDC
Must Turn-Off Voltage	1 VDC	1 VDC	1 VDC
Minimum Input Current	12 mA	10 mA	9 mA
Maximum Input Current	27 mA	15.5 mA	14 mA
Nominal Input Impedance [Ohms]	300	940	2k
Maximum Turn-On Time [msec]	1	1	1
Maximum Turn-Off Time [ $\mu$ sec]	300	300	300

**GENERAL SPECIFICATIONS <sup>(1)</sup>**

Description	Parameters
Dielectric Strength, Input to Output	2500 Vrms
Dielectric Strength, Output to Baseplate	2500 Vrms
Ambient Operating Temperature Range	-30 to 80°C
Ambient Storage Temperature Range	-30 to 125 °C
Weight (typical)	0.5 oz (14.4 g)
Terminals	3/16" x 0.032" input, 1/4" x 0.032" output QC
SSR Mounting Screw Torque Range	9.0-10.0 in-lb (1.0-1.13 Nm)
Humidity per IEC60068-2-78	93% non-condensing

**THERMAL DERATE INFORMATION**

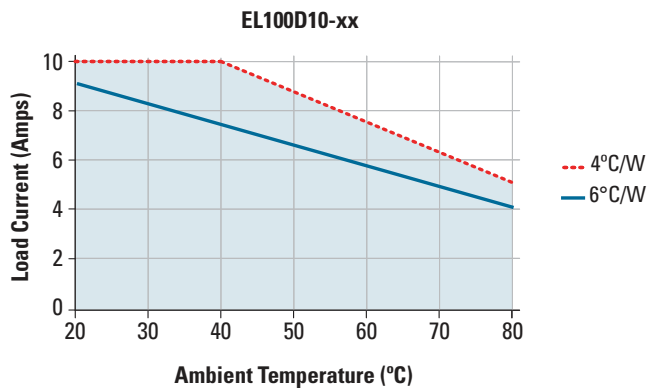
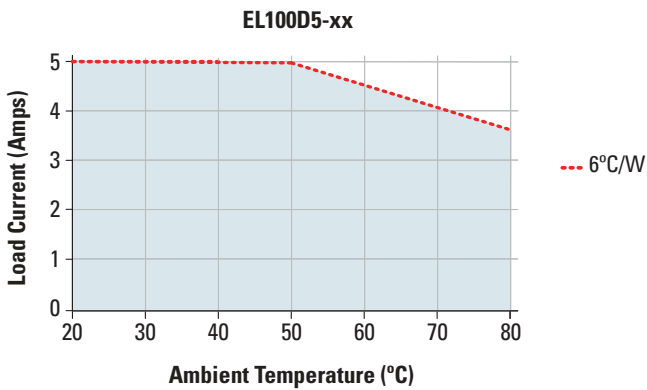

**EQUIVALENT CIRCUIT BLOCK DIAGRAM / WIRING DIAGRAMS**

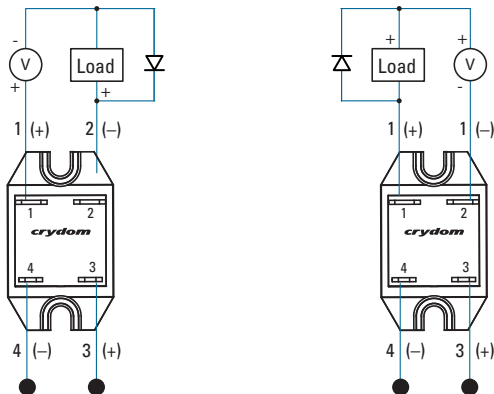
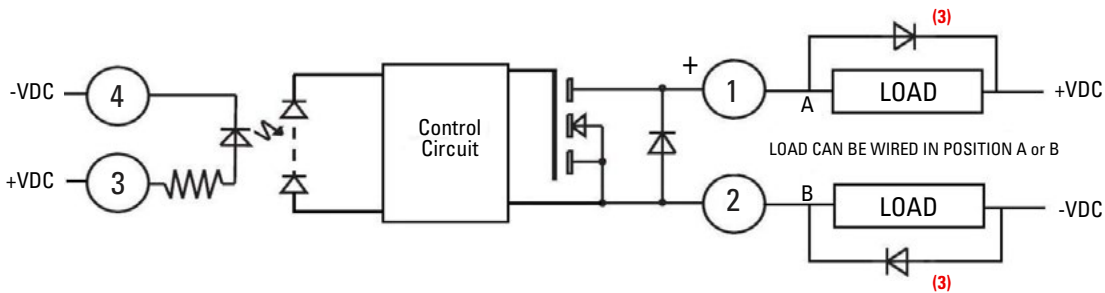

## MOUNTING INSTRUCTIONS

Choose one of the two mounting options and follow the instructions.

### Mounting on Heat Sinks

- Select adequate heat sink. (Please refer to thermal derating curves for the specific model)
- Be sure that thermal pad is pre-installed before installing over the heat sink.
- EL mounting slots have a diameter of 0.16 in (4.0 mm). Two screws are needed (not included) to mount the EL onto heat sink (See fig. 1). recommended screw size is 8-32 (UNC standard) or M4 (metric).
- Before applying full torque tighten down both screws until they contact the baseplate. Then, tighten them to 9.0-10.0 in-lb (1.0-1.13 Nm).
- For optimal thermal performance heat sink fins should be oriented vertically to promote natural convection airflow.

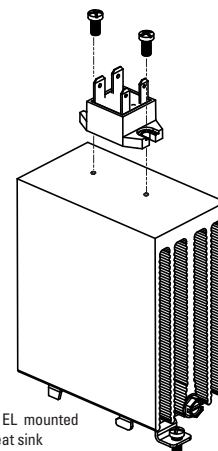

fig.1 EL mounted on heat sink

### Mounting on Panels

- Locate the panel section on which the EL will be mounted. Panel mount surface must provide adequate heat sinking capability, uncoated, clean, flat (0.004 in/in recommended) and preferably aluminum.
- Be sure that thermal pad is pre-installed before install over the heatsink.
- EL mounting slots have a diameter of 0.16 in (4.0 mm). Two screws are needed (not included) to mount the EL onto panel. Choose screw length considering the mounting surface hole depth and that the SSR flange thickness is 0.125 in (3.2 mm).
- Before applying full torque tighten down both screws until they contact the baseplate. Then, tighten them to 10 in-lb (1.13 Nm).

### Transient Protection

- An inductive load will produce harmful transient voltage when it is turned off. The more perfect the switch, the larger the transient voltages. The MOSFET output is so nearly ideal switch that the transient voltages produced by seemingly "non-inductive" loads can cause damage if not suppressed. Diodes should be fast recovery type with PIV rated greater than supply voltage. (3)

**MECHANICAL SPECIFICATIONS**

Tolerances: ±0.02 in / 0.5 mm  
All dimensions are in: inches [millimeters]

**Standard Quick Connect terminals**

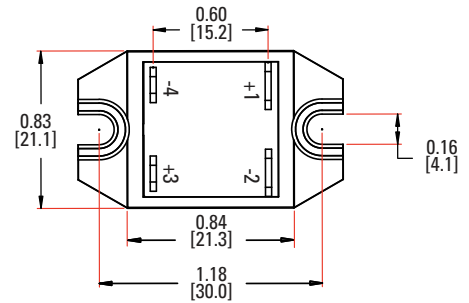
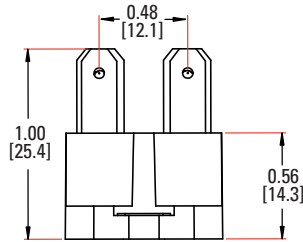
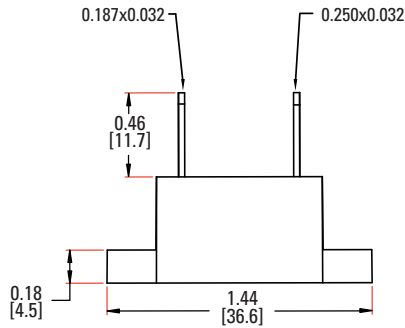

**Pinout**  
Terminal 1: +DC load  
Terminal 2: -DC load  
Terminal 3: +DC control  
Terminal 4: -DC control

**90° bent Quick Connect terminals**

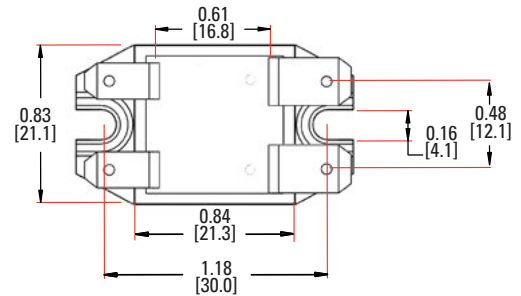
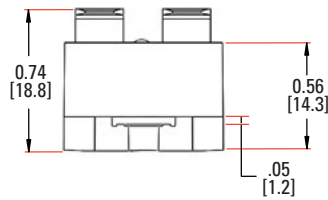
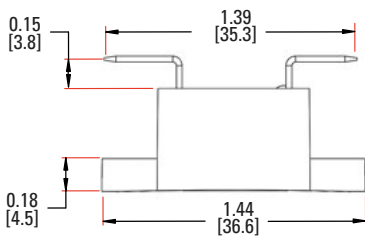

**AGENCY APPROVALS, CONFORMANCES AND EMC**



**Certification in accordance with:**

United States Standard for Industrial Control Equipment - UL 508 and  
Canadian Standard Association for Industrial Control Equipment – C22.2 No. 14.

TUV SUD according to IEC 60335-1.

Vibration and Shock Resistance:  
IEC 61373 : Category 1, Class B.

**GENERAL NOTES**

- (1) All parameters at 25°C unless otherwise specified.
- (2) When mounted to the proper size heat sink (see derating curves)
- (3) Inductive loads should be diode suppressed to prevent damage to the relay.

Rev. 102017  
ECN 20340

**⚠ DANGER / PELIGRO / DANGER /GEFAHR / PERICOLO / 危險**

<p><b>HAZARD OF ELECTRIC SHOCK, EXPLOSION, OR ARC FLASH.</b></p> <ul style="list-style-type: none"> <li>• Disconnect all power before installing or working with this equipment.</li> <li>• Verify all connections and replace all covers before turning on power.</li> </ul> <p><b>Failure to follow these instructions will result in death or serious injury.</b></p>	<p><b>RIESGO DE DESCARGA ELECTRICA O EXPLOSION.</b></p> <ul style="list-style-type: none"> <li>• Desconectar todos los suministros de energia a este equipo antes de trabajar con este equipo.</li> <li>• Verificar todas las conexiones y colocar todas las tapas antes de energizar el equipo.</li> </ul> <p><b>El incumplimiento de estas instrucciones puede provocar la muerte o lesiones serias.</b></p>	<p><b>RISQUE DE DESCARGE ELECTRIQUE OU EXPLOSION</b></p> <ul style="list-style-type: none"> <li>• Eteindre toutes les sources d'énergie de cet appareil avant de travailler dessus de cet appareil</li> <li>• Vérifier tous connections, et remettre tous couverts en place avant de mettre sous</li> </ul> <p><b>De non-suivi de ces instructions provoquera la mort ou des lésions sérieuses.</b></p>	<p><b>GEFAHR EINES ELEKTRISCHE N SCHLAGES ODER EINER EXPLOSION.</b></p> <ul style="list-style-type: none"> <li>• Stellen Sie jeglichen Strom ab, der dieses Gerät versorgt, bevor Sie an dem Gerät Arbeiten durchführen</li> <li>• Vor dem Drehen auf Energie alle Anschlüsse überprüfen und alle Abdeckungen ersetzen.</li> </ul> <p><b>Unterlassung dieser Anweisungen können zum Tode oder zu schweren Verletzungen führen.</b></p>	<p><b>RISCHIO DI SCOSSA ELETTRICA O DELL'ESPLOSIONE.</b></p> <ul style="list-style-type: none"> <li>• Spenga tutta l'alimentazione che fornisce questa apparecchiatura prima di lavorare a questa apparecchiatura</li> <li>• Verificare tutti i collegamenti e sostituire tutte le coperture prima dell'accensione</li> </ul> <p><b>L'omissione di queste istruzioni provocherà la morte o lesioni serie</b></p>	<p><b>存在电击、爆炸或电弧闪烁危险</b></p> <ul style="list-style-type: none"> <li>• 在操作此设备之前请先关闭电源。</li> </ul> <p><b>若不遵守这些说明,可能会导致严重的人身伤害甚至死亡。</b></p>
--	--	---	--	--	---

**⚠ WARNING / AVERTISSEMENT / WARNUNG /ADVERTENCIA / AVVERTENZA / 警告**

<p><b>RISK OF MATERIAL DAMAGE AND HOT ENCLOSURE</b></p> <ul style="list-style-type: none"> <li>• The product's side panels may be hot, allow the product to cool before touching.</li> <li>• Follow proper mounting instructions including torque values.</li> <li>• Do not allow liquids or foreign objects to enter this product.</li> </ul> <p><b>Failure to follow these instructions can result in serious injury, or equipment damage.</b></p>	<p><b>RISQUE DE DOMMAGE MATERIEL ET DE SURCHAUFFE DU BOITIER</b></p> <ul style="list-style-type: none"> <li>• Les panneaux latéraux du produit peuvent être chauds. Laisser le produit refroidir avant de le toucher.</li> <li>• Respecter les consignes de montage, et notamment les couples de serrage.</li> <li>• Ne pas laisser pénétrer de liquide ni de corps étrangers à l'intérieur du produit.</li> </ul> <p><b>Le non-respect de cette directive peut entraîner, des lésions corporelles graves ou des dommages matériels.</b></p>	<p><b>GEFAHR VON MATERIALSCHÄDEN UND GEHÄUSEERHITZUNG</b></p> <ul style="list-style-type: none"> <li>• Die Seitenwände können heiß sein. Lassen Sie das Produkt abkühlen, bevor Sie es berühren.</li> <li>• Beachten Sie die Montageanweisungen,</li> <li>• Führen Sie keine Flüssigkeiten oder Fremdkörper in das Produkt ein.</li> </ul> <p><b>Die Nichtbeachtung dieser Anweisung kann Körperverletzung oder Materialschäden zur Folge haben.</b></p>
<p><b>RIESGO DE DAÑOS MATERIALES Y DE SOBRECALENTAMIENTO DE LA UNIDAD</b></p> <ul style="list-style-type: none"> <li>• Los paneles laterales del producto pueden estar calientes. Esperar que el producto se enfríe antes de tocarlo.</li> <li>• Respetar las instrucciones de montaje, y en particular los pares de apretado.</li> <li>• No dejar que penetren líquidos o cuerpos extraños en el producto.</li> </ul> <p><b>Si no se respetan estas precauciones pueden producirse graves lesiones, daños materiales.</b></p>	<p><b>RISCHIO DI DANNI MATERIALI E D'INVOLUCRO CALDO</b></p> <ul style="list-style-type: none"> <li>• I pannelli laterali dell'apparecchio possono scottare; lasciar quindi raffreddare il prodotto prima di toccarlo.</li> <li>• Seguire le istruzioni di montaggio corrette.</li> <li>• Non far entrare liquidi o oggetti estranei in questo apparecchio.</li> </ul> <p><b>La mancata osservanza di questa precauzione può causare gravi rischi per l'incolumità personale o danni alle apparecchiature.</b></p>	<p><b>材料损坏和高温外壳的危险性</b></p> <ul style="list-style-type: none"> <li>• 产品的一侧面板可能很热, 在其冷却前请不要触碰。</li> <li>• 遵照正确的安装说明, 包括扭矩值。</li> <li>• 请勿让液体及其他异物进入本产品。</li> </ul> <p><b>如不能正确执行这些操作说明, 极有可能造成严重人体伤害或者设备的损坏。</b></p>

**ANNEX - ENVIRONMENTAL INFORMATION**

The environmental information disclosed in this annex including the EIP Pollution logo are in compliance with People’s Republic of China Electronic Industry Standard SJ/T11364 – 2006, Marking for Control of Pollution Caused by Electronic Information Products.

Part Name	Toxic or hazardous Substance and Elements					
	Lead (Pb)	Mercury (Hg)	Cadmium (Cd)	Hexavalent Chromium (Cr (VI))	Polybrominated biphenyls (PBB)	Polybrominated diphenyl ethers (PBDE)
Semiconductor die	X	O	O	O	O	O

附件 – 环保信息

此附件所标示的包括电子信息产品污染图标的环保信息符合中华人民共和国电子行业标准 SJ/T11364 - 2006, 电子信息产品污染控制标识要求。

部件名称	有毒有害物质或元素					
	铅 (Pb)	汞 (Hg)	镉 (Cd)	六价铬 (Cr (VI))	多溴联苯 (PBB)	多溴二苯醚 (PBDE)
半导体芯片	X	O	O	O	O	O



## X-ON Electronics

Largest Supplier of Electrical and Electronic Components

*Click to view similar products for [Solid State Relays - Industrial Mount](#) category:*

*Click to view products by [Sensata](#) manufacturer:*

Other Similar products are found below :

[D2440-C](#) [H10CA4890](#) [D4875C](#) [1395831-1](#) [1616010-6](#) [BR312BY](#) [A-1326](#) [H10CA4850](#) [H12CA4890VL](#) [RA2410-D06](#) [RA2410HA06T](#)  
[D1202F](#) [D53TP50-10](#) [W230E-1-12](#) [W230T-3-12](#) [1-1617030-3](#) [1-1617033-7](#) [MS2-D2420](#) [MS2-D2430](#) [A-1440](#) [RJ1P60V50E](#) [HS501DR-](#)  
[D2425](#) [RN1F48I50](#) [70.362.1028.0](#) [7-1393030-8](#) [Z5.509.0828.0](#) [G3DZ-4B DC24](#) [G3DZ-F4B DC12](#) [2912138](#) [SSRDAC10](#) [SSR-10048RD1](#)  
[RV8S-L-A240-D24](#) [RV8S-L-A240-D6](#) [RV8S-S-A240-D6](#) [RV8S-S-A240Z-D24](#) [RV8S-S-D24-A240](#) [RV8S-S-D48-A120](#) [RN1F12V50](#)  
[RJ1P60I30E](#) [RJ1P60V30E](#) [SO967860](#) [SMT8628521](#) [SO869970](#) [SOD867180](#) [SAL961360](#) [SO867970](#) [SOB863860](#) [SOB867640](#) [G3PH-](#)  
[5150B DC5-24](#) [G3PH-2075B DC5-24](#)