

PM67 SERIES

PANEL MOUNT SOLID STATE RELAYS

Introduction

The PM67 is a compact 3-phase solid state relay in a panel mountable 67.5mm wide package with output ratings up to 75 Amps per channel @ 40°C. Its built-in overvoltage protection and the optional overtemperature protection make it suitable for demanding heating, motion and lighting applications. It's easy to install and its large cage clamp terminals allow connecting wires up to 2 AWG size on the output terminals without the use of any additional accessories, therefore reducing installation cost and time. UL approved and VDE certified, the PM67 is a powerful and versatile solid state relay with superior performance when compared to previous generations and competitor products.



Features

- 3-Phase AC Output Panel Mount SSRs
- Output ratings up to 75 Amps at 600 VAC
- 2 & 3 controlled Legs option
- Over Temperature protection w/alarm (optional)
- Built-in overvoltage protection
- Clamp Cage terminal type accepts up to 2 AWG wire size.
- Layout of mounting holes compatible with standard hockey puck SSRs
- IP20 touch-safe housing
- AC or DC control
- cURus and VDE approved

Applications

- Plastic injection molding equipment
- Packaging equipment
- Industrial ovens
- Lighting control
- Professional cooking equipment
- Pump control
- Conveyor drives
- HVAC&R

NOVA22



PRODUCT SELECTION

Control Voltage	25A	30A	50A	55A	60A	75A
4-32 VDC	PM6760D25P	PM6760D30P	PM6760D50P	PM6760D55P	PM6760D60P	PM6760D75P
90-280 VAC/VDC	PM6760A25P	PM6760A30P	PM6760A50P	PM6760A55P	PM6760A60P	PM6760A75P



ORDERING OPTIONS

Example : PM6760A25RPTA

Description of part number example

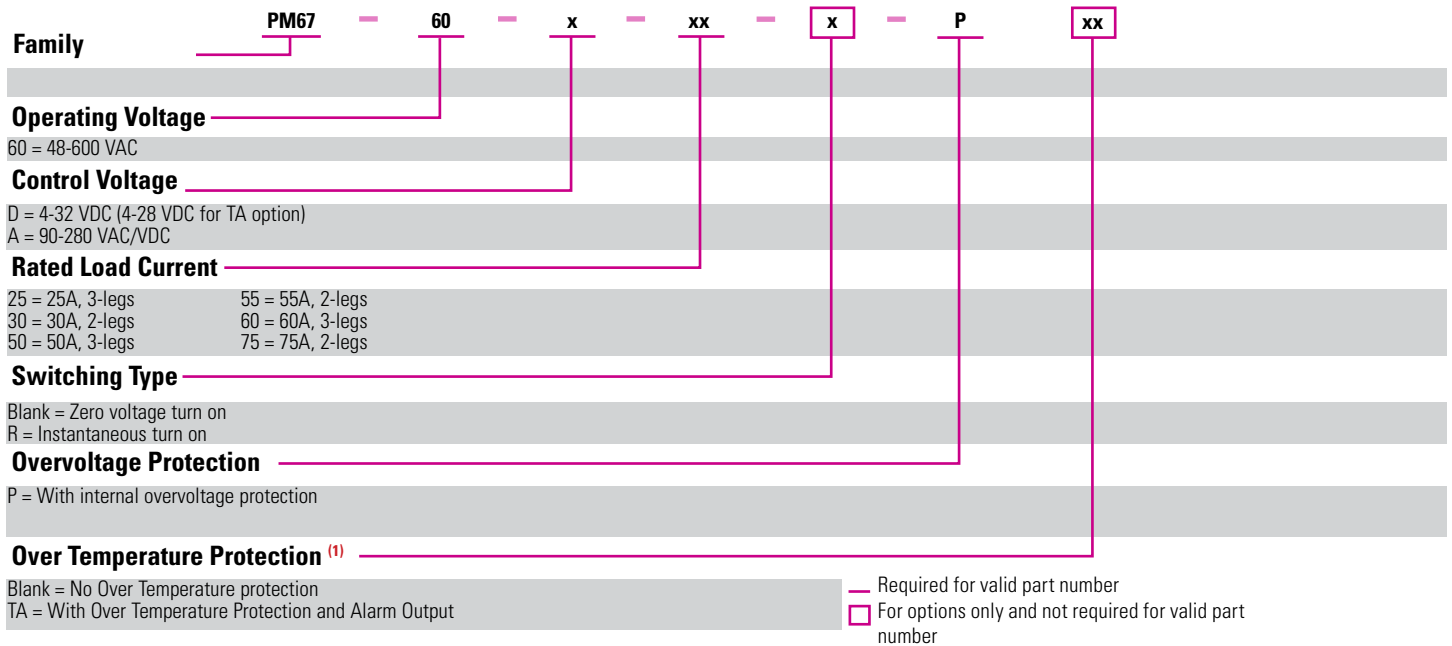

SPECIFICATIONS

Output⁽²⁾

Description	25A	30A	50A	55A	60A	75A
Operating Voltage (47-440Hz) [V_{RMS}]	48-600	48-600	48-600	48-600	48-600	48-600
Transient Overvoltage [Vpk] ⁽³⁾	1200	1200	1200	1200	1200	1200
Maximum Off-State Leakage Current @ Rated Voltage [mA_{RMS}]	1	1	1	1	1	1
Minimum Off-State dV/dt @ Maximum Rated Voltage [V/μsec]	500	500	500	500	500	500
Load Current, General Use UL508/LC A IEC62314 @ 40°C [A_{RMS}]	25	30	50	55	60	75
Load Current, Motor Starting UL508 FLA/LC B IEC62314 @ 40°C [A_{RMS}]	6.4/3.9	6.4/3.9	12/6.8	12/6.8	21/17.6	21/17.6
Minimum Load Current [mA_{RMS}]	100	100	100	100	150	150
Maximum 1 Cycle Surge Current (50/60Hz) [A_{pk}]	286/300	286/300	716/750	716/750	1290/1350	1290/1350
Maximum On-State Voltage Drop @ Rated Current [V_{RMS}]	1.25	1.3	1.25	1.3	1.15	1.20
Maximum 1/2 Cycle I² t for Fusing (50/60Hz) [A² sec]	409/375	409/375	2563/2343	2563/2343	8320/7593	8320/7593
Minimum Power Factor (at Maximum Load)	0.5	0.5	0.5	0.5	0.5	0.5
Motor Rating UL 508: 120 VAC / 240 VAC / 480 VAC [HP]	0.5/1.0/3.0	0.75/1.0/3.0	1.5/3.0/7.5	1.5/3.0/7.5	3.0/5.0/15.0	3.0/5.0/15.0
Motor Rating IEC62314: 240 VAC / 400 VAC / 500 VAC [kW]	0.75/1.5/2.2	0.75/1.5/2.2	1.5/3.0/4.0	1.5/3.0/4.0	4.0/7.5/11.0	4.0/7.5/11.0

Input⁽²⁾

Description	PM6760Dxxx		PM6760Axxx	
	wo-TA Option	w-TA Option	wo-TA Option	w-TA Option
Control Voltage Range	4-32 VDC ⁽⁴⁾	4-28 VDC ⁽⁴⁾	90-280 VAC/VDC	
Maximum Reverse Voltage	-32 VDC		-	
Minimum Turn-On Voltage	4 VDC		90 VAC/VDC	
Must Turn-Off Voltage	1 VDC		5 VAC/VDC	
Minimum Input Current (for on-state)	25 mA	20 mA	1 mA	1 mA
Maximum Input Current	40 mA	50 mA	4 mA	8 mA
Nominal Input Impedance	Current Limited		Switching mode	
Maximum Turn-On Time [msec]	1/2 Cycle ⁽⁵⁾		10	
Maximum Turn-Off Time [msec]	1/2 Cycle		20	

Alarm⁽²⁾

Description	PM6760Dxxx	PM6760Axxx
Output type	Solid State	Solid State
Maximum Output Voltage	60 VDC	400 VDC / 265 VAC
Maximum Alarm Output Current [mA]	60	60

General⁽²⁾

Description	Parameters
Dielectric Strength, Input to Output (50/60Hz)	4k V _{RMS}
Dielectric Strength, Input/Output to Case (50/60Hz)	4k V _{RMS}
Minimum Insulation Resistance (@ 500 VDC)	10 ⁹ Ohms
Maximum Capacitance, Input/Output	25 pF
Ambient Operating Temperature Range	-40 to 80 °C
Ambient Storage Temperature Range	-40 to 100 °C
Short Circuit Current Rating ⁽⁶⁾	100 kA
Weight (typical)	6.7 oz (190 g)
Housing Material	UL94 V-0
Heat Sink Material	Aluminum
DIN Rail Clip Material	Zinc Plated Steel
Hardware Finish	Nickel Plating
Input Terminal Screw Torque Range (lb-in/Nm)	5/0.5
Load Terminal Screw Torque Range (lb-in/Nm)	18-20/2.0-2.2
Humidity per IEC 60068-2-78 ⁽⁷⁾	93%
LED Input Status Indicator	See status chart
Overvoltage Category	III
Impulse Withstand Voltage According to IEC 60664-1	6kV



EQUIVALENT CIRCUIT BLOCK DIAGRAMS/WIRING DIAGRAMS

PM6760XXX

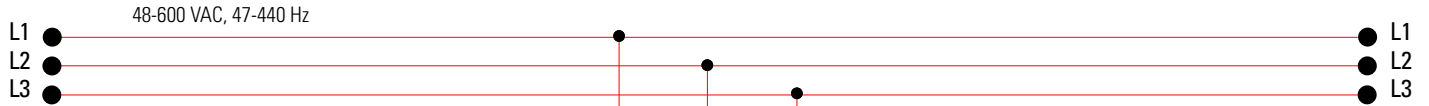

Short circuit and overload current protection

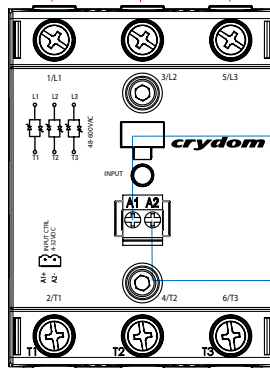
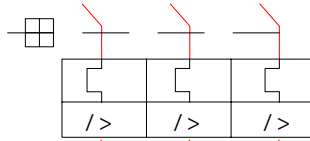

CONTROL INPUT

Motor Controller Application

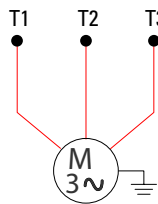

General Use Application

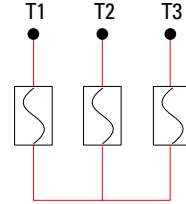

PM6760X(30,55,75)
(2 CONTROLLED LEGS)

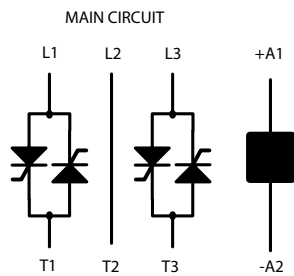

PM6760X(25,50,60)
(3 CONTROLLED LEGS)

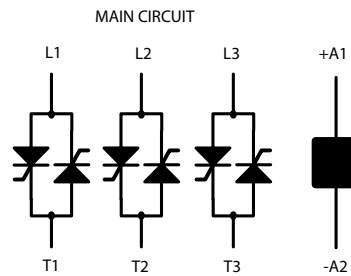

PM6760XXXTA

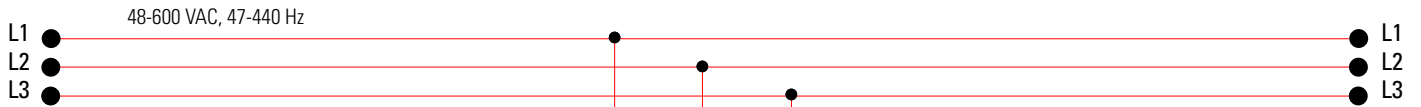

Short circuit and overload current protection

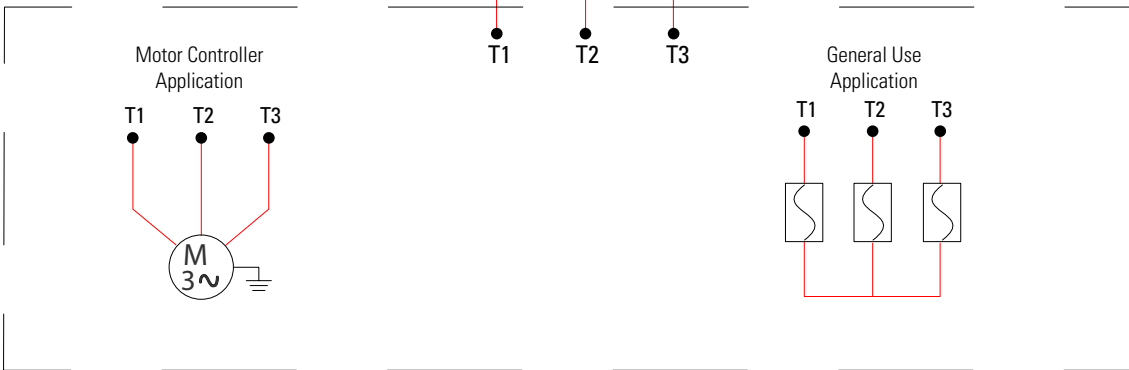
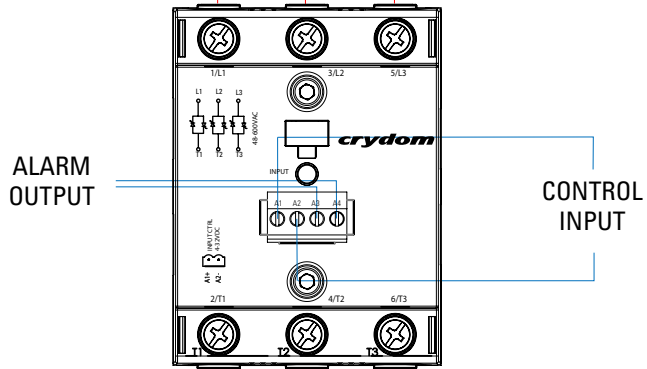
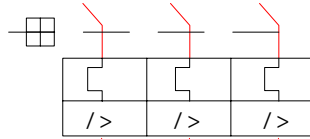

PM6760X(30,55,75)TA
(2 CONTROLLED LEGS)

PM6760X(25,50,60)TA
(3 CONTROLLED LEGS)

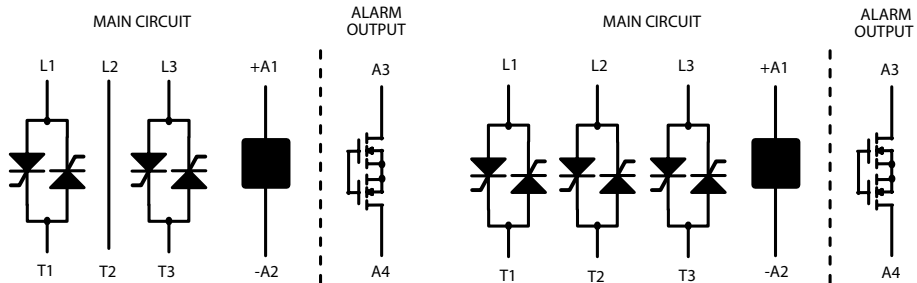



MECHANICAL SPECIFICATIONS

Tolerances: ± 0.02 in / 0.5 mm
All dimensions are in inches [mm]

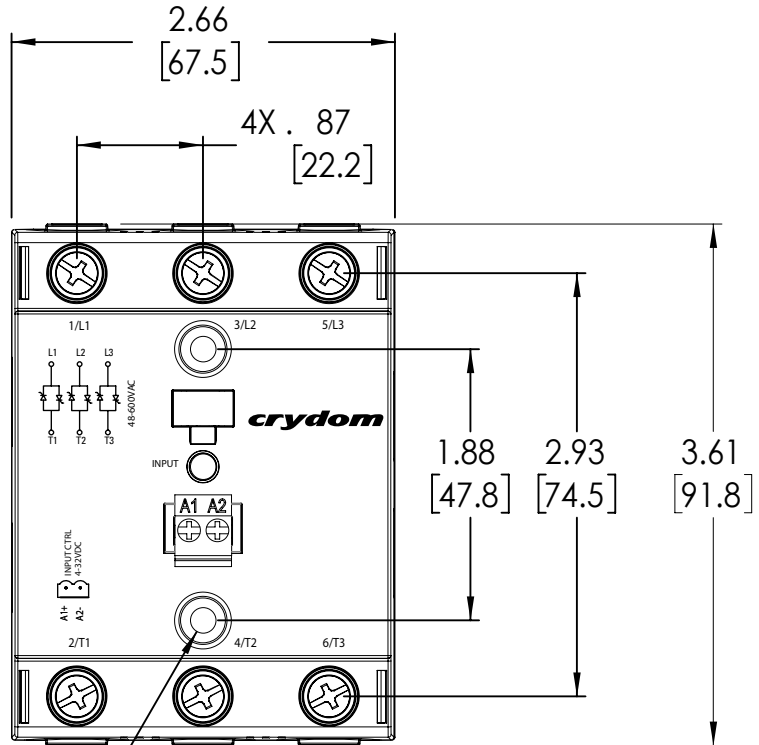

2X \varnothing .18 [4.5]
MOUNTING HOLE

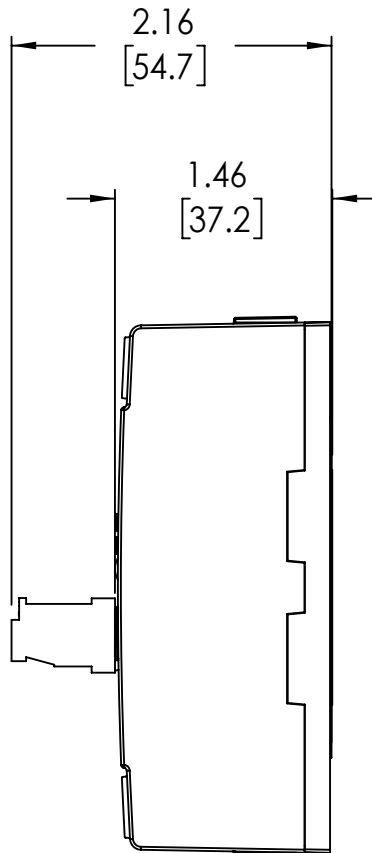



SURGE CURRENT INFORMATION⁽⁸⁾

25A & 30A

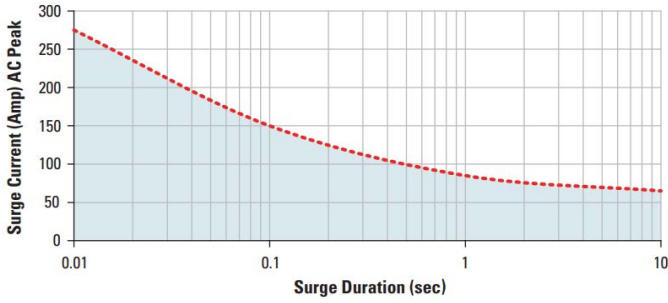

50A & 55A

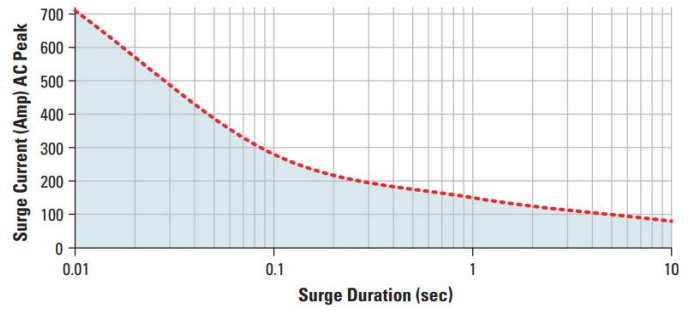

60A & 75A

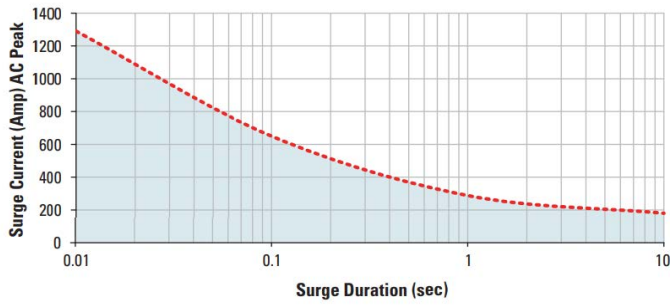

THERMAL DERATE INFORMATION

PM6760x25

— 0.5°C/W — 0.7°C/W - - - 1.0°C/W

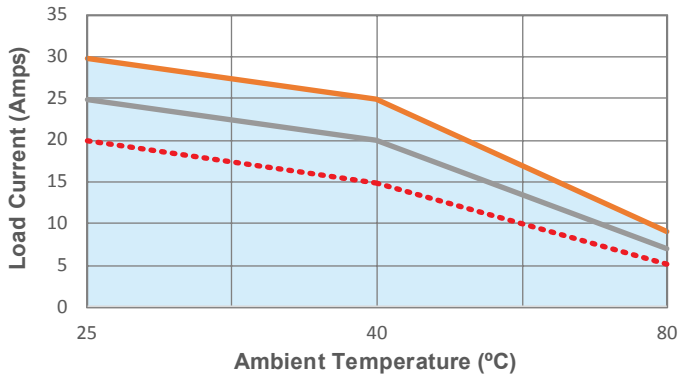

PM6760x30

— 0.5°C/W — 0.7°C/W - - - 1.0°C/W

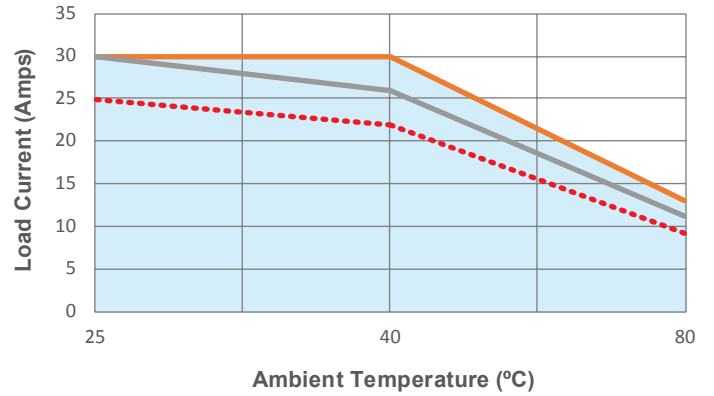

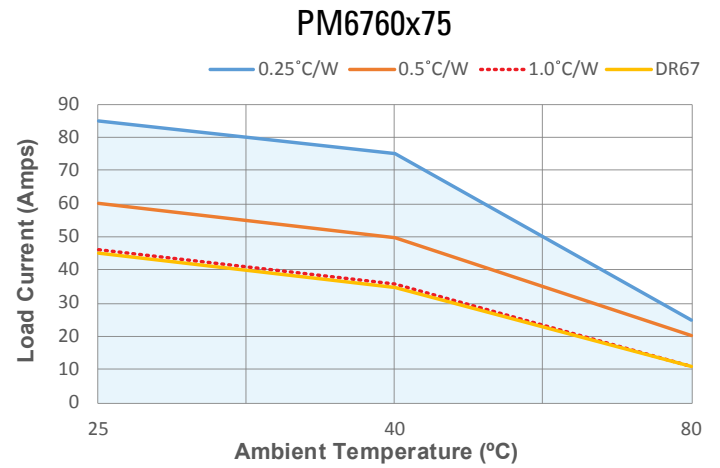
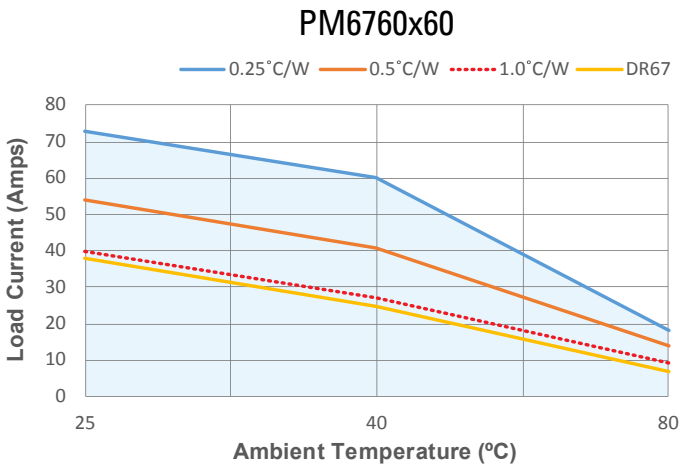
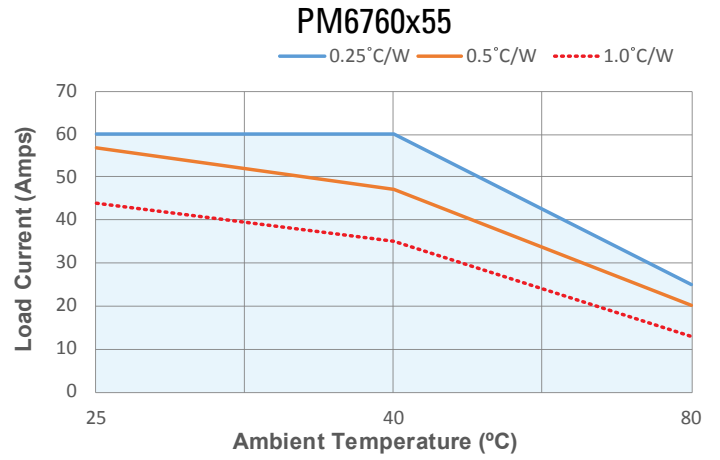
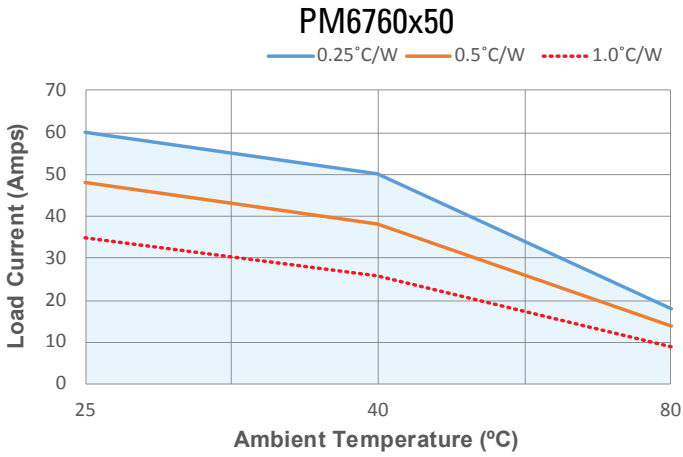

STATUS CHART

(only for models with overtemperature protection)

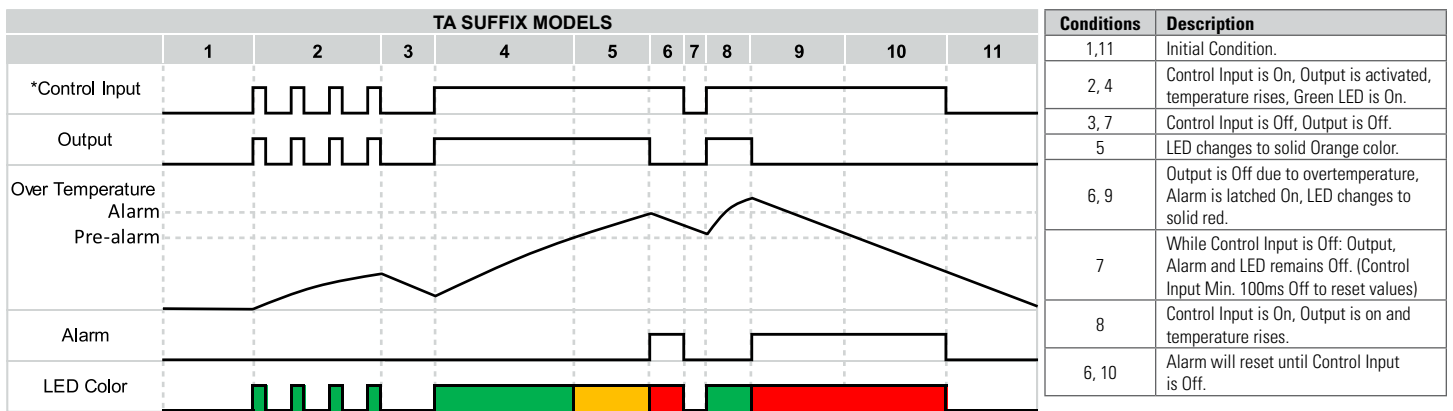

* Max. 60 ms OFF when applying PWM on Control Input.

LED Color	Green	Green	Output On
	Red	Red	Alarm
	Yellow	Yellow	Pre-Alarm



Mounting on Heat Sink

- Select adequate heat sink (see thermal derating curves in product series datasheet).
- Be sure to use a thermal pad (part no. HSP-8) or equivalent thermal compound between the SSR and the selected heat sink.
- SSR housing mounting holes have a diameter of 0.341in (8.66mm). Two screws are needed to mount the SSR onto a heat sink (See fig.1). Mounting screws are sold separately as HK8. Otherwise, recommended screw size is 8-32 (socket) using an allen wrench (9/64 in) for the installation. Choose screw length considering mounting surface hole depth and SSR baseplate thickness of 0.125 in (3.2 mm).
- Before applying full torque tighten down both screws until they contact the baseplate. Then, tighten them to 20 lb-in (2.2 Nm) min.
- For optimal thermal performance heat sink fins should be oriented vertically to promote natural convection airflow

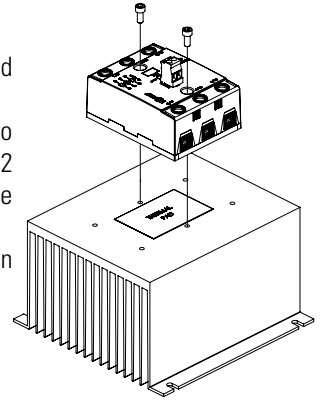

fig.1 SSR mounted on HS053 heat sink

Mounting on Panel

- Locate the panel section on which the SSR will be mounted. Panel mount surface must provide adequate heat sinking capability, uncoated, clean, flat (0.004 in/in recommended) and preferably aluminum.
- Be sure to use thermal pad HSP-8 or equivalent thermal compound between the SSR and the panel.
- SSR housing mounting slots have a diameter of 0.341 in (8.66 mm). Two screws are needed (not included) to mount the SSR onto a panel. Mounting screws are sold separately as HK8. Otherwise, recommended screw size is 8-32 (socket) using allen wrench (9/64 in) for the installation. Choose screw length considering the mounting surface and that the SSR baseplate thickness is 0.125 in (3.2 mm).
- Before applying full torque tighten down both screws until they contact the baseplate. Then, tighten them to 20 lb-in (2.2 Nm) min

Wiring Instructions

- Recommended wire sizes as shown in TABLE 1
- Maximum terminal screw torque input terminal 5 lb-in (0.5 Nm) (screw terminal only)
- Maximum terminal screw torque load terminal 18-20 lb-in (2.0-2.2 Nm)
- Strip length for input terminals: Per manufacturer specifications
- Strip length for load terminals: 10mm min.
- Use only copper conductors rated for 75°C

Table 1. Wire Size & Pull Out Strength			
Terminal Configuration	Recommended Wire Size (Solid/Stranded)	Wire Pull-Out Strength (lb)[N]*	
Output	1 x 18 AWG (1 mm ²) [minimum]	20 [88]	
	1 x 8 AWG (10 mm ²)	75 [333]	
	2 x 8 AWG (10 mm ²)	65 [289]	
	1 x 3 AWG (26.67 mm ²) ⁽¹⁾	90 [400]	
Input	Screw	30 AWG (0.05 mm ²) [minimum]	4.5 [20]
		12 AWG (3.3 mm ²) [maximum]	30 [133]
	Spring ⁽²⁾	26 AWG (0.13 mm ²) [minimum]	5 [22]
		12 AWG (3.3 mm ²) [maximum]	5 [22]







*Tests performed on Stranded wire

⁽¹⁾ Maximum wire size 1 x 2 AWG (35mm²)

⁽²⁾ Applicable when using CP202 connector instead of supplied connector







ACCESSORIES

Recommended Accessories					
					
Hardware Kit	Heat Sink	Thermal	Thermal Pad	Connectors	ID Marker
	Part No.	Resistance [°C/W]			
HK8	HS073 HS053 HS033 HS023	0.7 0.5 0.36 0.25	HSP-8	CP201 CP202	CNLB CNLN CNL2



AGENCY APPROVALS & CERTIFICATIONS

Approvals (Tested and Certified According To)	
 E116949	 40047491
UL 508 and C22.2 No. 14	EN 62314

CONFORMANCES		ENVIRONMENTAL		
Vibration and Shock Resistance	Resistances to heat and fire			
IEC 61373: Category 1, Class B	IEC 60335-1, Section 30	Directive 2006/95/EC	Directive 2011/65/EU	GBT 26572-2011

Electromagnetic Compatibility				
Generic Standard	Immunity Tests	Test Specification Level		Performance
 IEC 61000-6-2 Immunity for Industrial Environments"	Electrostatic Discharge IEC 61000-4-2	8kV air discharge		Criterion A
		6kV contact discharge		Criterion A
	Fast transient (burst) IEC 61000-4-4	Output	2kV, 5kHz, 100kHz	Criterion B
		Input	1kV, 5kHz, 100kHz	Criterion B
	Surge IEC 61000-4-5	Output	1kV Line to Line	Criterion B
			2kV Line to Earth	Criterion B
		AC Input Option	1kV Line to Line	Criterion A
			2kV Line to Earth	Criterion A

GENERAL NOTES

- (1) Option available upon demand. Please contact your local Sensata representative for additional information.
- (2) All parameters at 25°C unless otherwise specified per Channel.
- (3) Output will self trigger between 900-1200 Vpk, not suitable for capacitive loads.
- (4) Increase minimum voltage by 1 V for operations from -20 to -40°C.
- (5) Turn-on time for Instantaneous turn-on versions is 0.1 msec.
- (6) When protected with the appropriate class and rated fuse. For detailed info please contact Sensata Technical Support.
- (7) No freezing or condensation allowed.
- (8) For single surge pulse $T_c=25^\circ\text{C}$; $T_j=125^\circ\text{C}$. For AC Output SSRs, AC RMS value of surge current equals the peak value divided by 2 (1.414).

WARNINGS



RISK OF MATERIAL DAMAGE AND HOT ENCLOSURE

- The product's side panels may be hot, allow the product to cool before touching
- Follow proper mounting instructions including torque values
- Do not allow liquids or foreign objects to enter this product

Failure to follow these instructions can result in serious injury, or equipment damage.



HAZARD OF ELECTRIC SHOCK, EXPLOSION OR ARC FLASH

- Disconnect all power before installing or working with this equipment
- Verify all connections and replace all covers before turning on power

Failure to follow these instructions will result in death or serious injury.

Sensata Technologies, Inc. ("Sensata") data sheets are solely intended to assist designers ("Buyers") who are developing systems that incorporate Sensata products (also referred to herein as "components"). Buyer understands and agrees that Buyer remains responsible for using its independent analysis, evaluation and judgment in designing Buyer's systems and products. Sensata data sheets have been created using standard laboratory conditions and engineering practices. Sensata has not conducted any testing other than that specifically described in the published documentation for a particular data sheet. Sensata may make corrections, enhancements, improvements and other changes to its data sheets or components without notice.

Buyers are authorized to use Sensata data sheets with the Sensata component(s) identified in each particular data sheet. HOWEVER, NO OTHER LICENSE, EXPRESS OR IMPLIED, BY ESTOPPEL OR OTHERWISE TO ANY OTHER SENSATA INTELLECTUAL PROPERTY RIGHT, AND NO LICENSE TO ANY THIRD PARTY TECHNOLOGY OR INTELLECTUAL PROPERTY RIGHT, IS GRANTED HEREIN. SENSATA DATA SHEETS ARE PROVIDED "AS IS". SENSATA MAKES NO WARRANTIES OR REPRESENTATIONS WITH REGARD TO THE DATA SHEETS OR USE OF THE DATA SHEETS, EXPRESS, IMPLIED OR STATUTORY, INCLUDING ACCURACY OR COMPLETENESS. SENSATA DISCLAIMS ANY WARRANTY OF TITLE AND ANY IMPLIED WARRANTIES OF MERCHANTABILITY, FITNESS FOR A PARTICULAR PURPOSE, QUIET ENJOYMENT, QUIET POSSESSION, AND NON-INFRINGEMENT OF ANY THIRD PARTY INTELLECTUAL PROPERTY RIGHTS WITH REGARD TO SENSATA DATA SHEETS OR USE THEREOF.

All products are sold subject to Sensata's terms and conditions of sale supplied at www.sensata.com SENSATA ASSUMES NO LIABILITY FOR APPLICATIONS ASSISTANCE OR THE DESIGN OF BUYERS' PRODUCTS. BUYER ACKNOWLEDGES AND AGREES THAT IT IS SOLELY RESPONSIBLE FOR COMPLIANCE WITH ALL LEGAL, REGULATORY AND SAFETY-RELATED REQUIREMENTS CONCERNING ITS PRODUCTS, AND ANY USE OF SENSATA COMPONENTS IN ITS APPLICATIONS, NOTWITHSTANDING ANY APPLICATIONS-RELATED INFORMATION OR SUPPORT THAT MAY BE PROVIDED BY SENSATA.

Mailing Address: Sensata Technologies, Inc., 529 Pleasant Street, Attleboro, MA 02703, USA.

CONTACT US

Americas

+1 (877) 502 5500 – Option 2
sales.crydom@sensata.com

Europe, Middle East & Africa

+44 (1202) 416170
ssr-info.eu@sensata.com

Asia Pacific

sales.isasia@list.sensata.com
 China +86 (21) 2306 1500
 Japan +81 (45) 277 7117
 Korea +82 (31) 601 2004
 India +91 (80) 67920890
 Rest of Asia +886 (2) 27602006
 ext 2808

X-ON Electronics

Largest Supplier of Electrical and Electronic Components

Click to view similar products for [Solid State Relays - Industrial Mount](#) category:

Click to view products by [Sensata](#) manufacturer:

Other Similar products are found below :

[D2440-C](#) [H10CA4890](#) [D4875C](#) [1395831-1](#) [1616010-6](#) [BR312BY](#) [A-1326](#) [H10CA4850](#) [H12CA4890VL](#) [RA2410-D06](#) [RA2410HA06T](#)
[D1202F](#) [D53TP50-10](#) [W230E-1-12](#) [W230T-3-12](#) [1-1617030-3](#) [1-1617033-7](#) [MS2-D2420](#) [MS2-D2430](#) [A-1440](#) [RJ1P60V50E](#) [HS501DR-](#)
[D2425](#) [RN1F48I50](#) [70.362.1028.0](#) [7-1393030-8](#) [Z5.509.0828.0](#) [G3DZ-4B DC24](#) [G3DZ-F4B DC12](#) [2912138](#) [SSRDAC10](#) [SSR-10048RD1](#)
[RV8S-L-A240-D24](#) [RV8S-L-A240-D6](#) [RV8S-S-A240-D6](#) [RV8S-S-A240Z-D24](#) [RV8S-S-D24-A240](#) [RV8S-S-D48-A120](#) [RN1F12V50](#)
[RJ1P60I30E](#) [RJ1P60V30E](#) [SO967860](#) [SMT8628521](#) [SO869970](#) [SOD867180](#) [SAL961360](#) [SO867970](#) [SOB863860](#) [SOB867640](#) [G3PH-](#)
[5150B DC5-24](#) [G3PH-2075B DC5-24](#)