

SHT4x Smart Gadget User Guide

Sensirion's Reference Design for SHT4x Sensors

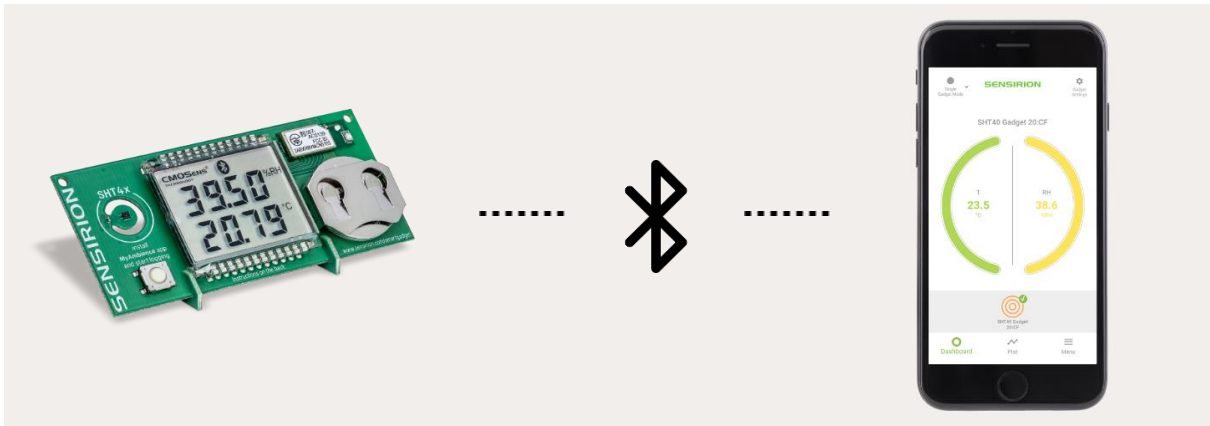

- SHT40 humidity and temperature sensor
- Liquid Crystal Display (LCD) for humidity, temperature and dew point in °C and °F
- Bluetooth Low Energy (BLE) connectivity
- iOS and Android MyAmbience app available for remote access
- Data logging and export capabilities
- Detailed hardware design resources available

Introduction

The SHT4x Smart Gadget is a simple reference design circuit board which demonstrates the outstanding performance and ease of use of Sensirion's SHT4x Humidity and Temperature sensors. It is equipped with a Liquid Crystal Display (LCD) showing humidity and temperature information. It also features a Bluetooth Low Energy (BLE) module allowing it to communicate with BLE capable devices like smartphones.

Development Kit Contents

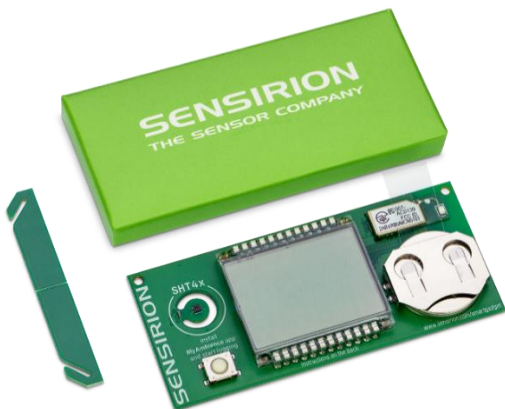

- **Smart Gadget** equipped with SHT40 sensor, LCD, push button and BLE capable MCU module, including battery, and supports.
- **MyAmbience app** for iOS and Android devices available for download in respective application stores.
- Detailed **hardware design resources** (PCB layout, BOM) available on GitHub.

Contents

1	Quick Start Guide	2
2	Standard Operations	3
2.1	Assembly Instructions.....	3
2.2	Operating in Standalone Mode.....	3
2.3	Operation in Bluetooth Mode.....	3
2.4	Connecting to a Bluetooth Device.....	3
2.5	Using the Smart Gadget as a Datalogger.....	3
2.6	System Requirement.....	3
2.7	Important Security Advice.....	4
3	MyAmbience Application	5
3.1	Device selection.....	5
3.2	Dashboard Panel.....	5
3.3	Plot Panel.....	6
3.4	Menu Panel.....	6
4	Hardware resources	7
4.1	Block Diagram.....	7
4.2	Bill of Materials.....	7
4.3	PCB Layout.....	8
5	Version History	9

1 Quick Start Guide

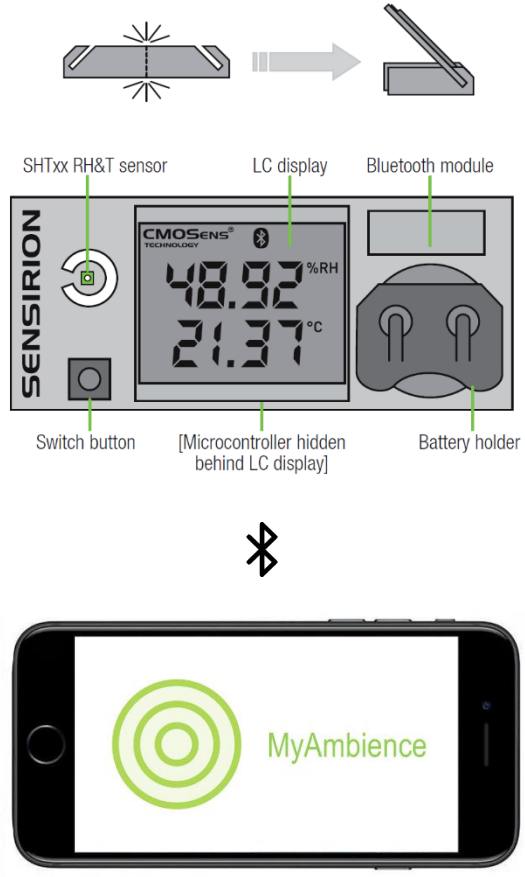
<p>1. Getting Started</p> <ul style="list-style-type: none"> ▪ Remove battery foil ▪ Break apart supports and slide main board into slots <p>2. Standalone Operation</p> <ul style="list-style-type: none"> ▪ RH&T values are shown on the LCD ▪ Switch between RH and dew point by pressing the button <p>3. Enabling/Disabling Bluetooth</p> <ul style="list-style-type: none"> ▪ Bluetooth is enabled by default ▪ With Bluetooth enabled (indicated by Bluetooth symbol on LCD) the gadget is ready to pair with a Bluetooth device ▪ To disable/enable Bluetooth, press the button for >2 seconds <p>4. Operation with MyAmbience App</p> <ul style="list-style-type: none"> ▪ Download iOS or Android version of the MyAmbience app on your smartphone ▪ Open the App to automatically see nearby smart gadgets on your smartphone 	 <p>The diagram illustrates the assembly process. At the top, a small component is shown being inserted into a slot. Below this, a detailed view of the gadget's front panel is shown. Labels point to various components: SHTxx RH&T sensor, LC display, Bluetooth module, Switch button, [Microcontroller hidden behind LC display], and Battery holder. The LCD display shows '48.92 %RH' and '21.37 °C'. A Bluetooth symbol is visible on the LCD. Below the gadget, a smartphone is shown with the MyAmbience app interface, featuring a green target icon and the text 'MyAmbience'.</p>
--	--

2 Standard Operations

2.1 Assembly Instructions

Take the two supports and break them apart. Slide the circuit board into the slots in the supports, with one support on each side of the Liquid Crystal Display. Remove battery insulation foil. Optionally, the temperature can be displayed in °F by pressing the button while inserting the battery.

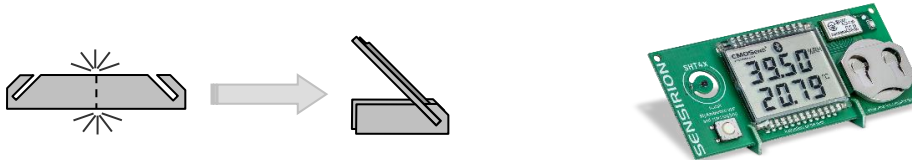

2.2 Operating in Standalone Mode

This is the default operating mode. The measured values are shown on the Liquid Crystal Display. The upper line shows relative humidity or dew point temperature, while the lower line shows temperature. To switch between relative humidity and dew point display, briefly press the button. To display temperature values in °F, press the button while inserting the battery.

2.3 Operation in Bluetooth Mode

Bluetooth mode is enabled by default. When Bluetooth mode is enabled, the Bluetooth symbol in the display is shown and the SHT4x Smart Gadget is visible for master devices. It is then possible for a master device running MyAmbience app to establish a connection to the Smart Gadget. To change Bluetooth mode (disabling or enabling), press the button for more than 2 seconds. When turning on Bluetooth, the device ID (in the format XX:XX) is shown on the display for a short time. The battery life is improved when the Bluetooth mode is disabled.

2.4 Connecting to a Bluetooth Device

To connect the Smart Gadget to a smartphone, the smartphone must have MyAmbience app installed and Bluetooth enabled. For Android devices, location permission needs to be granted to the app for it to work, although the user location will not be used at any time. The app will automatically connect to surrounding Smart Gadgets with Bluetooth enabled. To display values from a specific Smart Gadget, the corresponding Smart Gadget has to be selected in the list of connected gadgets. The MyAmbience app can be downloaded from the corresponding app stores:

iOS (Apple iTunes Store): <https://apps.apple.com/app/sensirion-myambience/id1529131572>

Android (Google Play Store): <https://play.google.com/store/apps/details?id=com.sensirion.myam>

2.5 Using the Smart Gadget as a Datalogger

The Smart Gadget stores the measurement values in the built-in memory. The measurement interval can be defined through the app in the “Gadget Settings” menu. The Smart Gadget will log measurement values even if the Bluetooth connection is terminated. The stored values can be downloaded, displayed on the smartphone via the app, or exported as .edf files.

2.6 System Requirement

In order for a mobile device to work with the Smart Gadget it needs to be Bluetooth 4.0 (also known as Bluetooth Low Energy or BLE) compatible. This is the case for most Android devices from 2013 and newer, Apple iPhones generation 4S and newer, and Apple iPad generation 3 and newer. The Smart Gadget apps run with Android 4.4 or later and iOS 9.0 or later, respectively.

2.7 Important Security Advice

- Keep out of reach of children and pets (contains swallowable parts)
- If any part is swallowed, contact a physician immediately
- Battery type: CR2032
- Dispose of the battery properly (special waste)
- Smart Gadget operating temperature range: -10 to 60 °C
- The Smart Gadget is intended for indoor use
- The Smart Gadget is sensitive to electrostatic discharge (ESD) – please take precautions



3 MyAmbience Application

3.1 Device selection

When Bluetooth is enabled, MyAmbience automatically scans for devices to connect with. When in the dashboard or plot panels, the devices which are connected to the application are displayed as concentric circles with the gadget's name underneath. Press on a device to select it. The selected device has a check mark on it and its information will be displayed in the dashboard or plot panel.

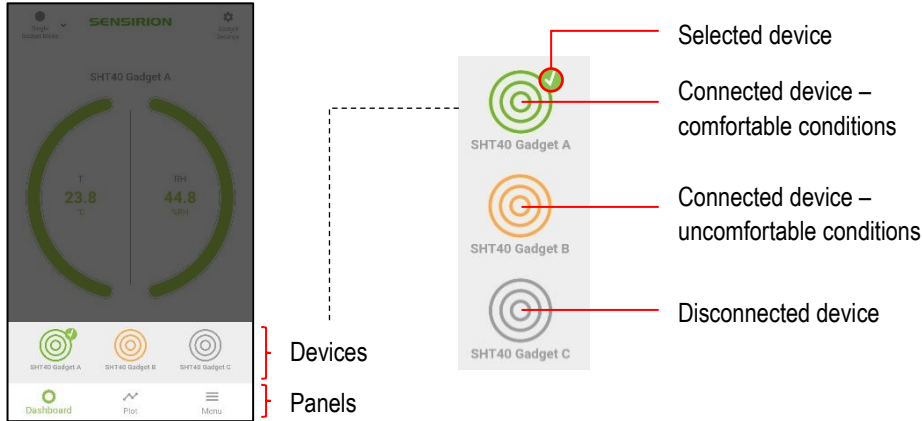

When the gadget logo (concentric circles) is green, it means that the environmental conditions measured by the gadget are deemed comfortable. If a device was connected during the runtime of the application but the connection is subsequently lost, the device logo will appear as grey in the list.

3.2 Dashboard Panel

The dashboard view displays the summary information of the Gadget's sensor readings. The colors for each signal (yellow, green, blue) indicate the level of environmental comfort based on the signal's value. "Cold" temperatures (<20°C) are indicated in blue, comfortable ones in green, and "hot" ones (>26°C) in yellow. Low relative humidity (<40%RH) (i.e. dry air) is indicated in yellow, comfortable relative humidity is indicated in green, and high relative humidity (>60%RH) in blue.

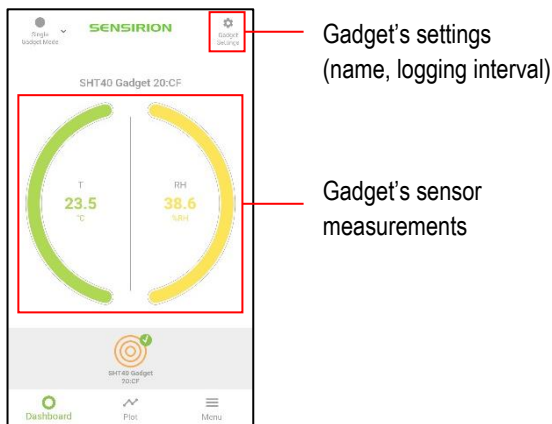

	Temperature	Relative Humidity
Dry / hot	> 26°C	0 – 40 %RH
Comfortable	20 – 26°C	40 – 60 %RH
Cold / humid	< 20°C	60 – 100 %RH

On the upper-right corner, one can access the gadget settings to change the gadget name and the logging interval with which the gadget should internally store the measured environmental data for later download.

3.3 Plot Panel

In the plot panel it is possible to plot the evolution of the environmental signals through time. One can change the signal to be displayed (temperature, relative humidity, etc) and the time scale of the graph. On the top-right corner, the Fetch Data button allows to download environmental data stored in the gadget's memory, according to the configured logging interval. The downloaded data can then be displayed on a graph. Next to the Fetch Data button, the Export button enables to save and send the recorded data as a .edf file.

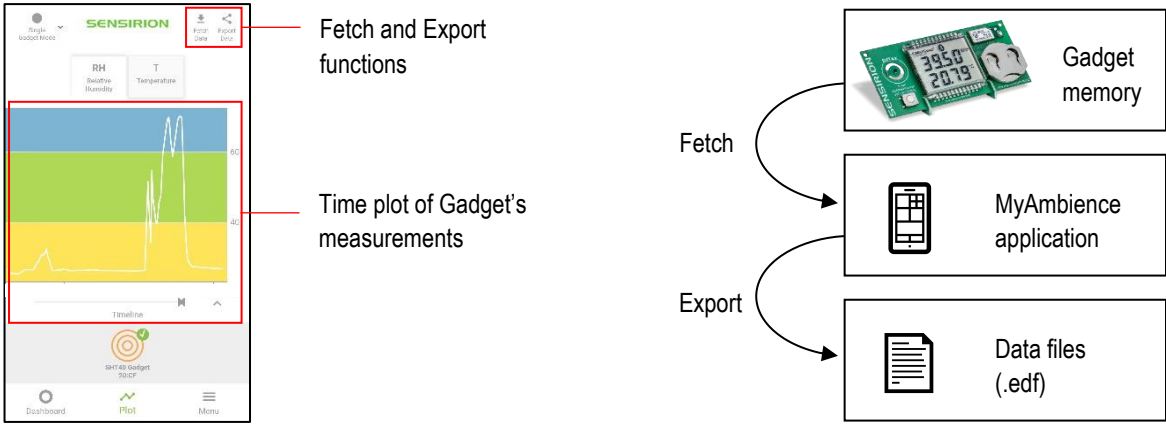

3.4 Menu Panel

In the menu panel, it is possible to find various information about the application and to load / export / manage logged data. Under the App Settings section, it is possible to change the temperature units ($^{\circ}\text{C}$, $^{\circ}\text{F}$, K), and to select other metrics to display (dew point, heat index, absolute humidity) in the Dashboard and Plot panel.

4 Hardware resources

Hardware design data (PCB layout, schematics, BOM) are published on Sensirion GitHub page: <https://github.com/Sensirion/smartgadget-sht4x-hardware>

4.1 Block Diagram

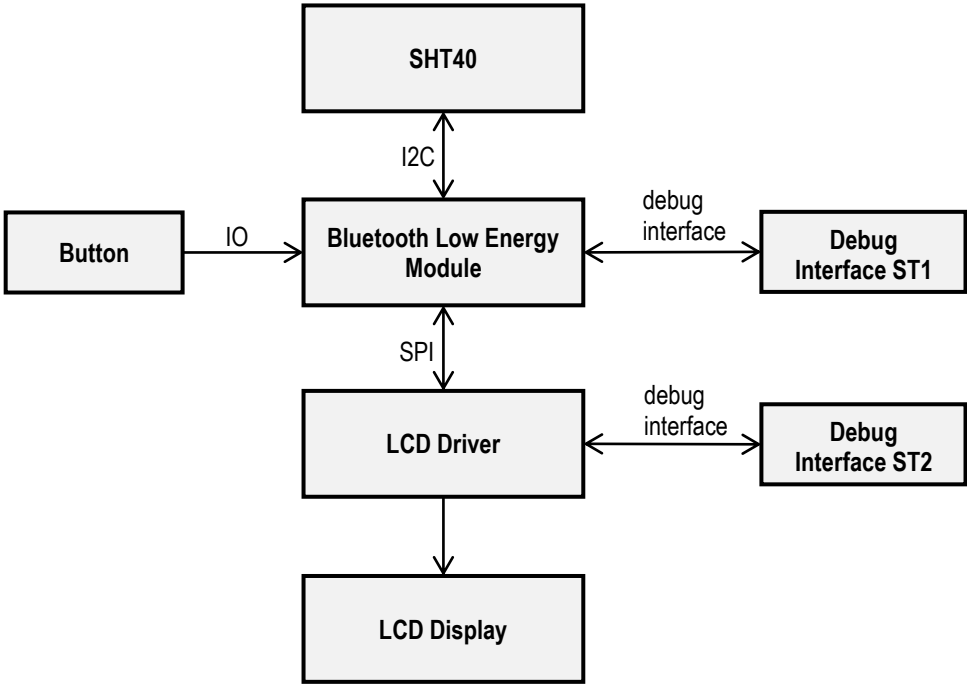

4.2 Bill of Materials

Component	Type	Qty.	Designator	Footprint	Manufacturer	Manufacturer Part Number
RH&T Sensor	SHT40-AD1B	1	SEN1	SHT4x-xD1	Sensirion AG	SHT40-AD1B-R2
BLE Module	BVMCN5103	1	IC2	BVMCN5103_Sma II	Braveridge	BVMCN5103-CEAA-BK
LCD driver	MC9S08LL8 CGT	1	IC1	QFN50P700X700 X80_HS-49N	NXP - Freescale Semiconductor	MC9S08LL8CGT
LCD Display	LCD	1	LCD1	LCD_1209061_A2	AV Display	LCD_1209061_A2
Battery holder	For CR2032 batteries	1	BAT1	BAT-HLD-001-THM	Linx Technologies	BAT-HLD-001-THM
Switch	Switch	1	SW1	SW_EVQQ2P02W	Panasonic Electronic Components	EVQ-Q2P02W
Crystal	ABS07-32.768KHZ-T	1	Q1	XTAL_ABS07	Abracon LLC	ABS07-32.768KHZ-T
Capacitors	100nF, 10V/X7R	9	C1, C2, C3, C4, C5, C6, C7, C8, C23	C_0402	n/a	n/a

Component	Type	Qty.	Designator	Footprint	Manufacturer	Manufacturer Part Number
Capacitors	For display support, no electrical function	4	C10, C11, C12, C13	C_0805	n/a	n/a
Capacitors	22uF, 6V3/X5R	4	C14, C15, C16, C17	C_0603	n/a	n/a
Resistors	10kOhm, 1%	2	R4, R6	R_0402	n/a	n/a

4.3 PCB Layout

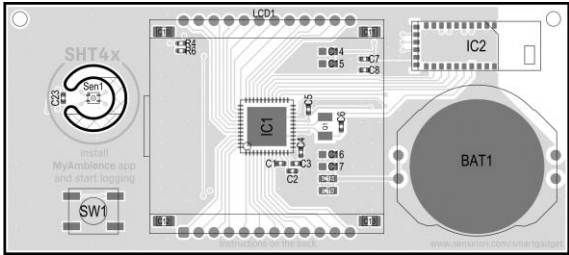

5 Version History

Date	Revision	Changes
10. May 2021	1	Initial version

Important Notices

Warning, Personal Injury

Do not use this product as safety or emergency stop devices or in any other application where failure of the product could result in personal injury. Do not use this product for applications other than its intended and authorized use. Before installing, handling, using or servicing this product, please consult the data sheet and application notes. Failure to comply with these instructions could result in death or serious injury.

If the Buyer shall purchase or use SENSIRION products for any unintended or unauthorized application, Buyer shall defend, indemnify and hold harmless SENSIRION and its officers, employees, subsidiaries, affiliates and distributors against all claims, costs, damages and expenses, and reasonable attorney fees arising out of, directly or indirectly, any claim of personal injury or death associated with such unintended or unauthorized use, even if SENSIRION shall be allegedly negligent with respect to the design or the manufacture of the product.

ESD Precautions

The inherent design of this component causes it to be sensitive to electrostatic discharge (ESD). To prevent ESD-induced damage and/or degradation, take customary and statutory ESD precautions when handling this product.

See application note "ESD, Latchup and EMC" for more information.

Warranty

SENSIRION warrants solely to the original purchaser of this product for a period of 12 months (one year) from the date of delivery that this product shall be of the quality, material and workmanship defined in SENSIRION's published specifications of the product. Within such period, if proven to be defective, SENSIRION shall repair and/or replace this product, in SENSIRION's discretion, free of charge to the Buyer, provided that:

- notice in writing describing the defects shall be given to SENSIRION within fourteen (14) days after their appearance;
- such defects shall be found, to SENSIRION's reasonable satisfaction, to have arisen from SENSIRION's faulty design, material, or workmanship;
- the defective product shall be returned to SENSIRION's factory at the Buyer's expense; and
- the warranty period for any repaired or replaced product shall be limited to the unexpired portion of the original period.

This warranty does not apply to any equipment which has not been installed and used within the specifications recommended by SENSIRION for the intended and proper use of the equipment. EXCEPT FOR THE WARRANTIES EXPRESSLY SET FORTH HEREIN, SENSIRION MAKES NO WARRANTIES, EITHER EXPRESS OR IMPLIED, WITH RESPECT TO THE PRODUCT. ANY AND ALL WARRANTIES, INCLUDING WITHOUT LIMITATION, WARRANTIES OF MERCHANTABILITY OR FITNESS FOR A PARTICULAR PURPOSE, ARE EXPRESSLY EXCLUDED AND DECLINED.

SENSIRION is only liable for defects of this product arising under the conditions of operation provided for in the data sheet and proper use of the goods. SENSIRION explicitly disclaims all warranties, express or implied, for any period during which the goods are operated or stored not in accordance with the technical specifications.

SENSIRION does not assume any liability arising out of any application or use of any product or circuit and specifically disclaims any and all liability, including without limitation consequential or incidental damages. All operating parameters, including without limitation recommended parameters, must be validated for each customer's applications by customer's technical experts. Recommended parameters can and do vary in different applications.

SENSIRION reserves the right, without further notice, (i) to change the product specifications and/or the information in this document and (ii) to improve reliability, functions and design of this product.

Copyright © 2021, by SENSIRION. CMOSens® is a trademark of Sensirion. All rights reserved

Headquarters and Subsidiaries

Sensirion AG

Laubisruetistr. 50
CH-8712 Staefa ZH
Switzerland

phone: +41 44 306 40 00
fax: +41 44 306 40 30
info@sensirion.com
www.sensirion.com

Sensirion Taiwan Co. Ltd

phone: +886 3 5506701
info@sensirion.com
www.sensirion.com

Sensirion Inc., USA

phone: +1 312 690 5858
info-us@sensirion.com
www.sensirion.com

Sensirion Japan Co. Ltd.

phone: +81 3 3444 4940
info-jp@sensirion.com
www.sensirion.com/jp

Sensirion Korea Co. Ltd.

phone: +82 31 337 7700~3
info-kr@sensirion.com
www.sensirion.com/kr

Sensirion China Co. Ltd.

phone: +86 755 8252 1501
info-cn@sensirion.com
www.sensirion.com/cn

To find your local representative, please visit www.sensirion.com/distributors

X-ON Electronics

Largest Supplier of Electrical and Electronic Components

Click to view similar products for [Board Mount Humidity Sensors](#) category:

Click to view products by [Sensirion](#) manufacturer:

Other Similar products are found below :

[HSHCAA114A](#) [MS860702BA01-50](#) [SI7013-A10-IM1](#) [GXHTC3](#) [10142048-10](#) [HIH8130-021-001](#) [CC2D35S-SIP](#) [CC2D33S-SIP](#) [CC2D33-SIP](#) [CC2D23S-SIP](#) [CC2D23-SIP](#) [1-100711-01](#) [HDC1050DMBR](#) [HIH6131-021-001](#) [HIH-4000-004](#) [HIH-4000-003](#) [HIH-4000-002](#) [HIH7120-021-001](#) [HIH6130-021-001](#) [1-101625-01](#) [HIH6021-021-001](#) [SHT35-DIS-B](#) [HDC2010YPAR](#) [SHT31-DIS-F2.5kS](#) [1-101466-01](#) [1-101462-01](#) [1-101465-01](#) [SYH-2R](#) [CC2D25S-SIP](#) [CC2D35-SIP](#) [HSHCAA006A](#) [HSHCAL101B](#) [CC2A23](#) [CC2A25](#) [CC2A33](#) [CC2A35](#) [CC2D23](#) [CC2D23S](#) [CC2D25](#) [CC2D25S](#) [CC2D25-SIP](#) [CC2D33](#) [CC2D33S](#) [CC2D35](#) [CC2D35S](#) [HS12SP](#) [HS20](#) [HS30P](#) [ENS210-LQFM](#) [BME280](#)