



# Specification ERT801

SSC		CUSTOMER
Drawn	Approval	Approval

Rev. 01

July 2009

[www.acriche.com](http://www.acriche.com)

Document No. : SSC-QP-7-07-24 (Rev.00)



# ERT801

1. Features
2. Absolute Maximum Ratings
3. Electro Characteristics
4. Optical characteristics
5. Outline Dimension
6. Packing
7. Soldering
8. Precaution for use

Rev. 01

July 2009

[www.acriche.com](http://www.acriche.com)

Document No. : SSC-QP-7-07-24 (Rev.00)

# ERT801

## Description

This surface-mount LED comes in PLCC standard package dimension. It has a substrate made up of a molded plastic reflector sitting on top of a bent lead frame. The die is attached within the reflector cavity and the cavity is encapsulated by epoxy or silicone

The package design coupled with careful selection of component materials allow these products to perform with high reliability in a larger temperature range -40°C to 100°C. The high reliability feature is crucial to Automotive interior and Indoor ESS.

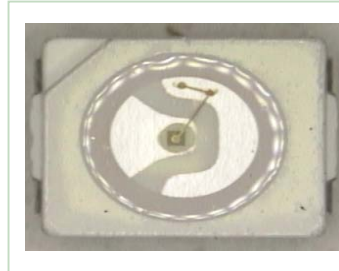

# ERT801

## Features

- Industry Standard PLCC SMT package
- High brightness using AlInGaP and InGaN dice technologies
- Available in multiple colors
- High volume, high reliability

## Applications

- Interior automotive
- Electronic Signs and Signals
- Office Automation, Electrical Appliances, Industrial Equipment



## 1. Features

- RED colored SMT package
- Material AlGaInP
- Suitable for all SMT assembly methods  
Suitable for all soldering methods
- RoHS Compliant

## 2. Absolute maximum ratings

Parameter	Symbol	Value	Unit
Power Dissipation	$P_d$	80	mW
Forward Current	$I_F$	30	mA
Peak Forward Current	$I_{FM}^{*2}$	90	mA
Reverse Voltage	$V_R$	5	V
Operating Temperature	$T_{opr}$	-40 ~ +100	°C
Storage Temperature	$T_{stg}$	-40 ~ +100	°C

\*1 Care is to be taken that power dissipation does not exceed the absolute maximum rating of the product.

\*2  $I_{FM}$  was measured at  $TW \leq 1\text{msec}$  of pulse width and  $D \leq 1/10$  of duty ratio.

## 3. Electric characteristics

Parameter	Symbol	Condition	Min	Typ	Max	Unit
Forward Voltage	$V_F$	$I_F = 20\text{mA}$	1.7	2.0	2.3	V
Reverse Current	$I_R$	$V_R = 5\text{V}$	-	-	10	$\mu\text{A}$
Luminance Intensity *1	$I_V$	$I_F = 20\text{mA}$	50	90	130	mcd
Peak Wavelength	$\lambda_P$	$I_F = 20\text{mA}$	-	650	-	nm
Dominant Wavelength	$\lambda_d$	$I_F = 20\text{mA}$	630	635	640	nm
Spectral Bandwidth 50%	$\Delta\lambda$	$I_F = 20\text{mA}$	-	18	-	nm
Viewing Angle *2	$2\theta_{1/2}$	$I_F = 20\text{mA}$	-	120	-	deg.

\*1. The luminous intensity  $I_V$  was measured at the peak of the spatial pattern which may not be aligned with the mechanical axis of the LED package. Luminous Intensity Measurement allowance is  $\pm 10\%$

\*2.  $2\theta_{1/2}$  is the off-axis where the luminous intensity is 1/2 of the peak intensity.

### 4. Optical characteristics

Forward Current vs. Forward Voltage

( $T_a=25\text{ }^\circ\text{C}$ )

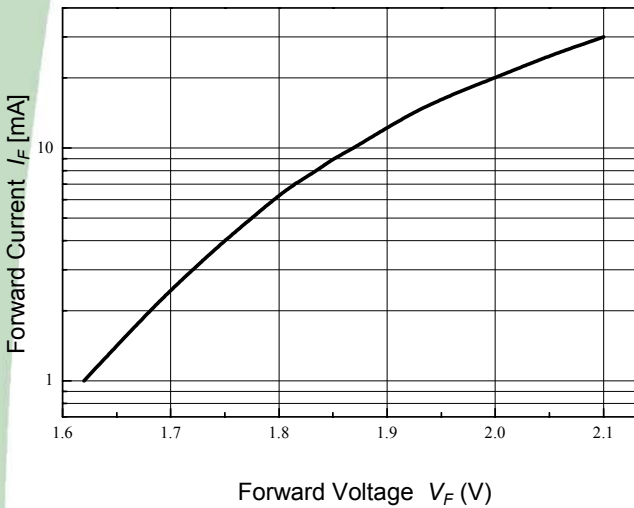

Relative Luminous Intensity vs Forward Current

( $T_a=25\text{ }^\circ\text{C}$ )

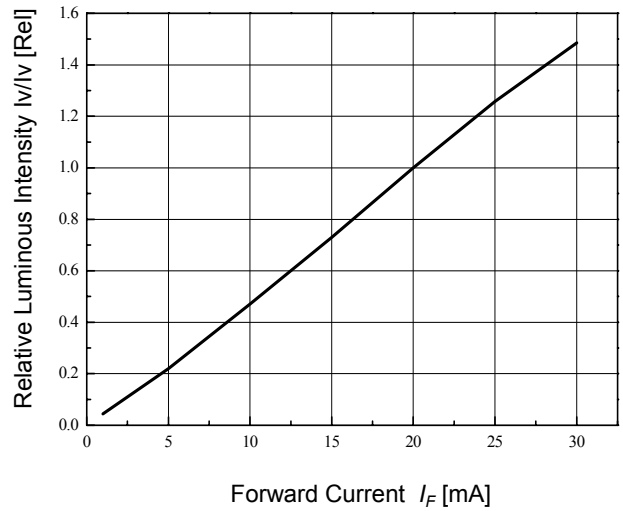

Forward Current Derating Curve

( $T_a=25\text{ }^\circ\text{C}$ )

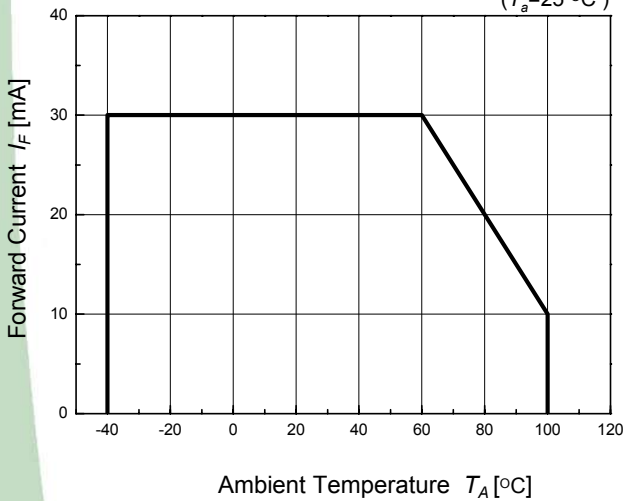

Radiation Diagram

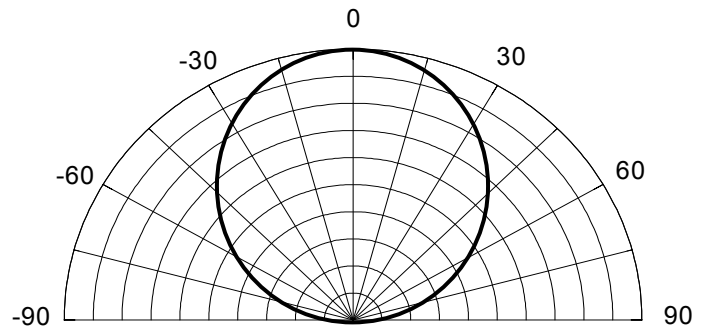

### 5.outline dimension

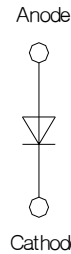
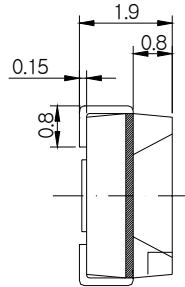
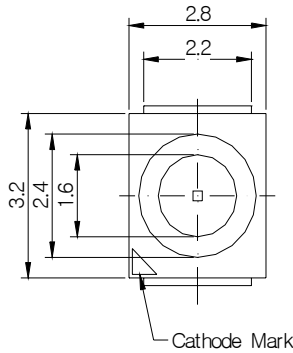

Recommended Solder Pattern

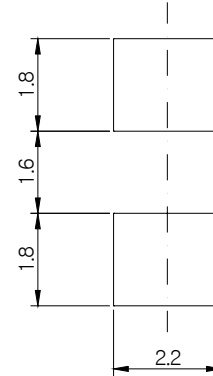

( Tolerance:  $\pm 0.2$ , Unit: mm )

### 6. packing

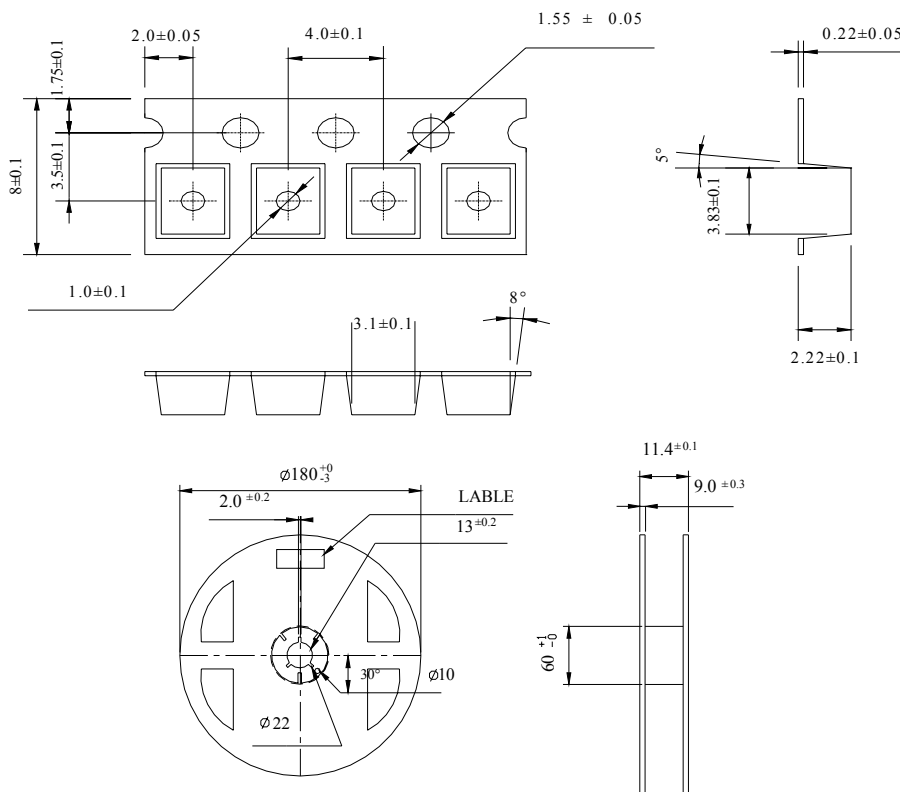

- (1) Quantity : 2000pcs/Reel
- (2) Cumulative Tolerance : Cumulative Tolerance/10 pitches to be  $\pm 0.2$ mm
- (3) Adhesion Strength of Cover Tape : Adhesion strength to be 0.1-0.7N when the cover tape is turned off from the carrier tape at the angle of  $10^\circ$  to the carrier tape
- (4) Package : P/N, Manufacturing data Code No. and quantity to be indicated on a damp proof Package

Rev. 01

July 2009

www.acriche.com

Document No. : SSC-QP-7-07-24 (Rev.00)

● Reel Packing Structure

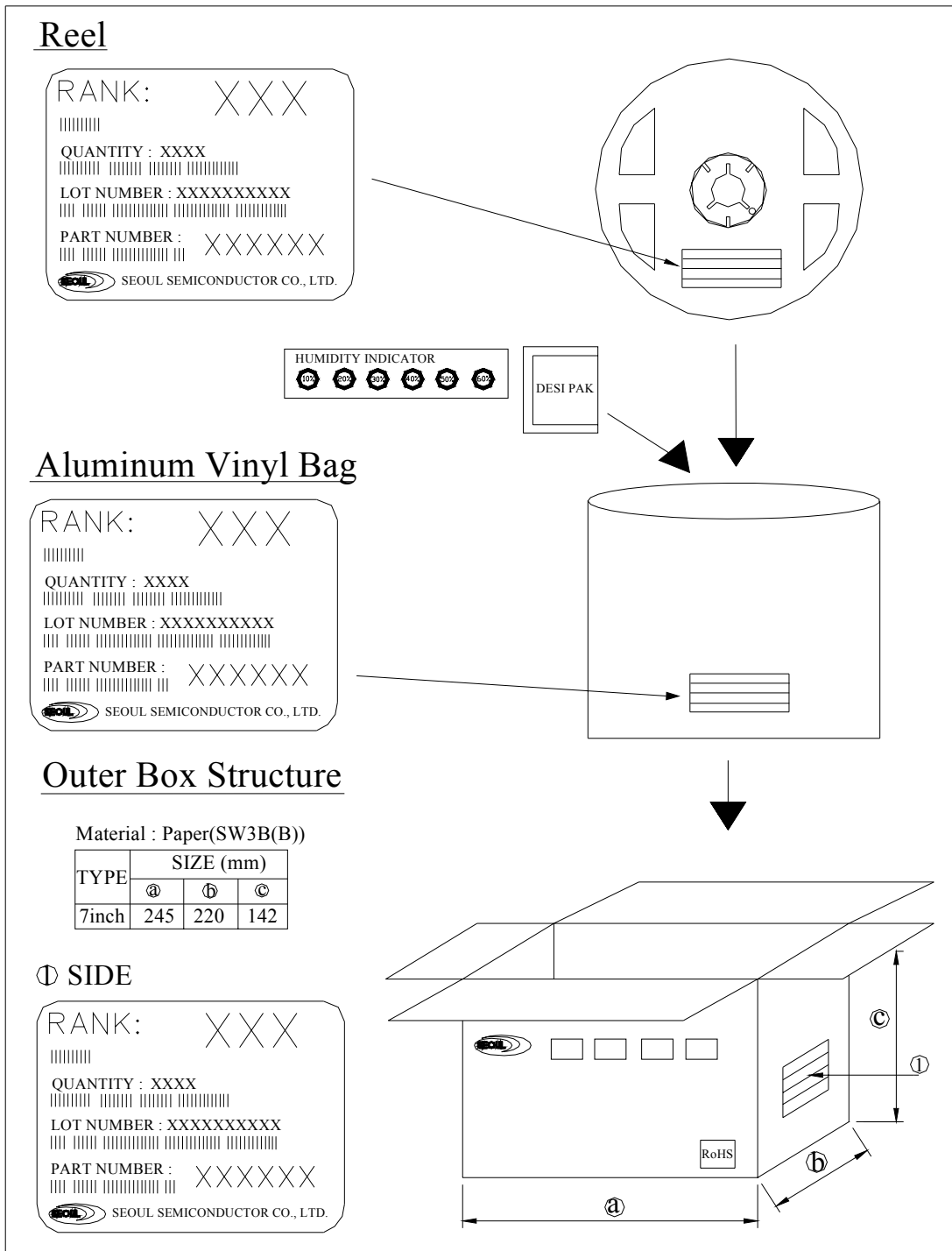



## 7. soldering

### (1) Lead Solder

Lead Solder	
Pre-heat	120~150 °C
Pre-heat time	120 sec. Max.
Peak-Temperature	240 °C Max.
Soldering time Condition	10 sec. Max.

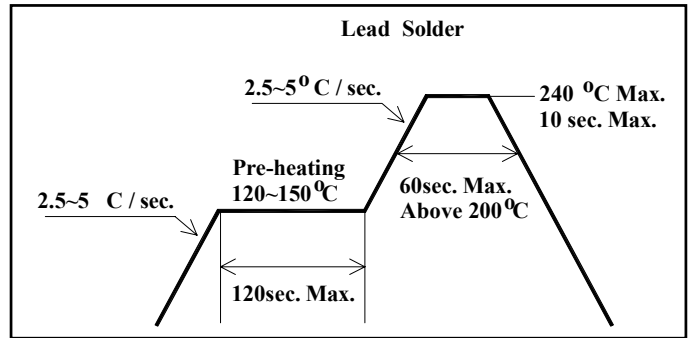

### (2) Lead-Free Solder

Lead Free Solder	
Pre-heat	150~200 °C
Pre-heat time	120 sec. Max.
Peak-Temperature	260 °C Max.
Soldering time Condition	10 sec. Max.

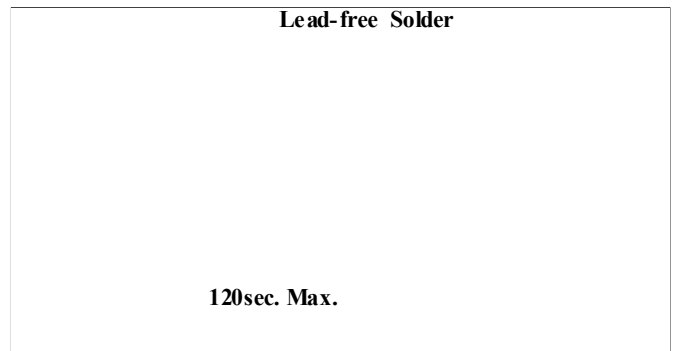

### (3) Hand Soldering conditions

Do not exceed 4 seconds at maximum 315°C under soldering iron.

Note : In case that the soldered products are reused in soldering process, we don't guarantee the products.

## 8. precaution for use

### (1) Storage

In order to avoid the absorption of moisture, it is recommended to store in a dry box (or a desiccator) with a desiccant. Otherwise, to store them in the following environment is recommended.

Temperature : 5°C ~30°C Humidity : maximum 70%RH

### (2) Attention after open.

LED is correspond to SMD, when LED be soldered dip, interfacial separation may affect the light transmission efficiency, causing the light intensity to drop. Attention in followed; Keeping of a fraction

Temperature : 5 ~ 40°C Humidity : less than 10%

(3) In the case of more than 1 week passed after opening or change color of indicator on desiccant, components shall be dried 10-12hr. at 60±5°C.

(4) Any mechanical force or any excess vibration shall not be accepted to apply during cooling process to normal temperature after soldering.

(5) Quick cooling shall be avoided.

(6) Components shall not be mounted on warped direction of PCB.

(7) Anti radioactive ray design is not considered for the products.

(8) This device should not be used in any type of fluid such as water, oil, organic solvent etc. When washing is required, IPA should be used.

(9) When the LEDs are illuminating, operating current should be decided after considering the ambient maximum temperature.

(10) The LEDs must be soldered within seven days after opening the moisture-proof packing.

(11) Repack unused products with anti-moisture packing, fold to close any opening and then store in a dry place.

(12) The appearance and specifications of the product may be modified for improvement without notice.

## X-ON Electronics

Largest Supplier of Electrical and Electronic Components

*Click to view similar products for [Standard LEDs - SMD category](#):*

*Click to view products by [Seoul Semiconductor manufacturer](#):*

Other Similar products are found below :

[LTST-C190KYKT](#) [LTST-C19GD2WT](#) [LTST-N683GBEW](#) [LTW-170ZDC](#) [LTW-M140SZS40](#) [598-8110-100F](#) [598-8170-100F](#) [598-8610-202F](#) [67-22VRVGC/TR8](#) [AAAF5060QBFSEEZGS](#) [HLMA-QG00-S0021](#) [HLMP-6305-L0011](#) [ALMD-LB36-SV002](#) [APT1608QGWW](#) [15-21UYC/S530-A3/TR8](#) [EAST2012YA0](#) [EASV1803BA0](#) [LG M67K-H1J2-24-0-2-R18-Z](#) [LS A676-P2S1-1](#) [SML310BATT86](#) [SML-512VWT86A](#) [SML-LX0606SISUGC/A](#) [SML-LXL1307SRC-TR](#) [SML-LXR851SIUPGUBC](#) [LT1ED53A](#) [FAT801-S](#) [AM27ZGC03](#) [APB3025SGNC](#) [APFA3010SURKCGKQBDC](#) [APHK1608VGCA](#) [APT2012QGWW](#) [CLX6D-FKB-CN1R1H1BB7D3D3](#) [LTST-C250KGKT](#) [LTW-020ZDCG](#) [LTW-21TS5](#) [LTW-220DS5](#) [JANTXM19500/521-02](#) [UYGT801-S](#) [42-21UYC/S530-A3/TR8](#) [LO T67F-V1AB-24-1](#) [YGFR411-H](#) [598-8330-117F](#) [SML-LX0402IC-TR](#) [CMDA20AYAA7D1S](#) [CMDA16AYDR7A1X](#) [598-8040-100F](#) [598-8070-100F](#) [598-8140-100F](#) [598-8610-200F](#) [EAST2012GA0](#)