



SEOUL SEMICONDUCTOR

**RoHS**

# Specification

## SAW09H0A

## SAW09H0A



### Description

The MJT series of LEDs are designed for AC & DC(High Voltage) operation and high flux output applications.

MJT's thermal management performance exceeds other power LED solutions by incorporating state-of-the-art SMD design and use of specialized thermal emission material. MJT is an ideal light source for general purpose illumination applications

## SAW09H0A

### Features

- Super high flux output and high luminance
- Designed for high voltage operation
- SMT solderable
- Lead free product
- RoHS compliant

### Applications

- LED bulb
- Spot light
- Architectural lighting
- Street light

\* The appearance and specifications of the product can be changed for improvement without notice.

## Full code of SAW09HOA

### 1. Part Number Form : X<sub>1</sub>X<sub>2</sub>X<sub>3</sub>X<sub>4</sub>X<sub>5</sub>X<sub>6</sub>X<sub>7</sub>X<sub>8</sub> – X<sub>9</sub>X<sub>10</sub>X<sub>11</sub>X<sub>12</sub>X<sub>13</sub>

X <sub>1</sub>	Company	S	SSC
X <sub>2</sub>	Package series	A	Acrich
X <sub>3</sub>	Color	W	White
X <sub>4</sub>		0	
X <sub>5</sub>	Series number	9	MJT4040
X <sub>6</sub>	Voltage	H	
X <sub>7</sub>	PCB type	0	Emitter
X <sub>8</sub>	Revision No.	A	Rev0
X <sub>9</sub> X <sub>10</sub>	Luminous flux	-	-
X <sub>11</sub> X <sub>12</sub>	Color bin	-	-
X <sub>13</sub>	Voltage	-	-

LF		Color bin	Voltage	
V3	140.0 ~ 154.0	B0~B5 C0~C5 D0~D5	A	60~63
W1	154.0 ~ 165.0		B	63~65
W2	165.0 ~ 177.0		C	65~68
W3	177.0 ~ 200.0			

### 2. Sticker Diagram on Reel & Aluminum Vinyl Bag

Rank : X<sub>9</sub> X<sub>10</sub> X<sub>11</sub> X<sub>12</sub> X<sub>13</sub>

QUANTITY : 700

Lot No : #####

SSC PART NUMBER : X<sub>1</sub> X<sub>2</sub> X<sub>3</sub> X<sub>4</sub> X<sub>5</sub> X<sub>6</sub> X<sub>7</sub> X<sub>8</sub>



Outline dimensions

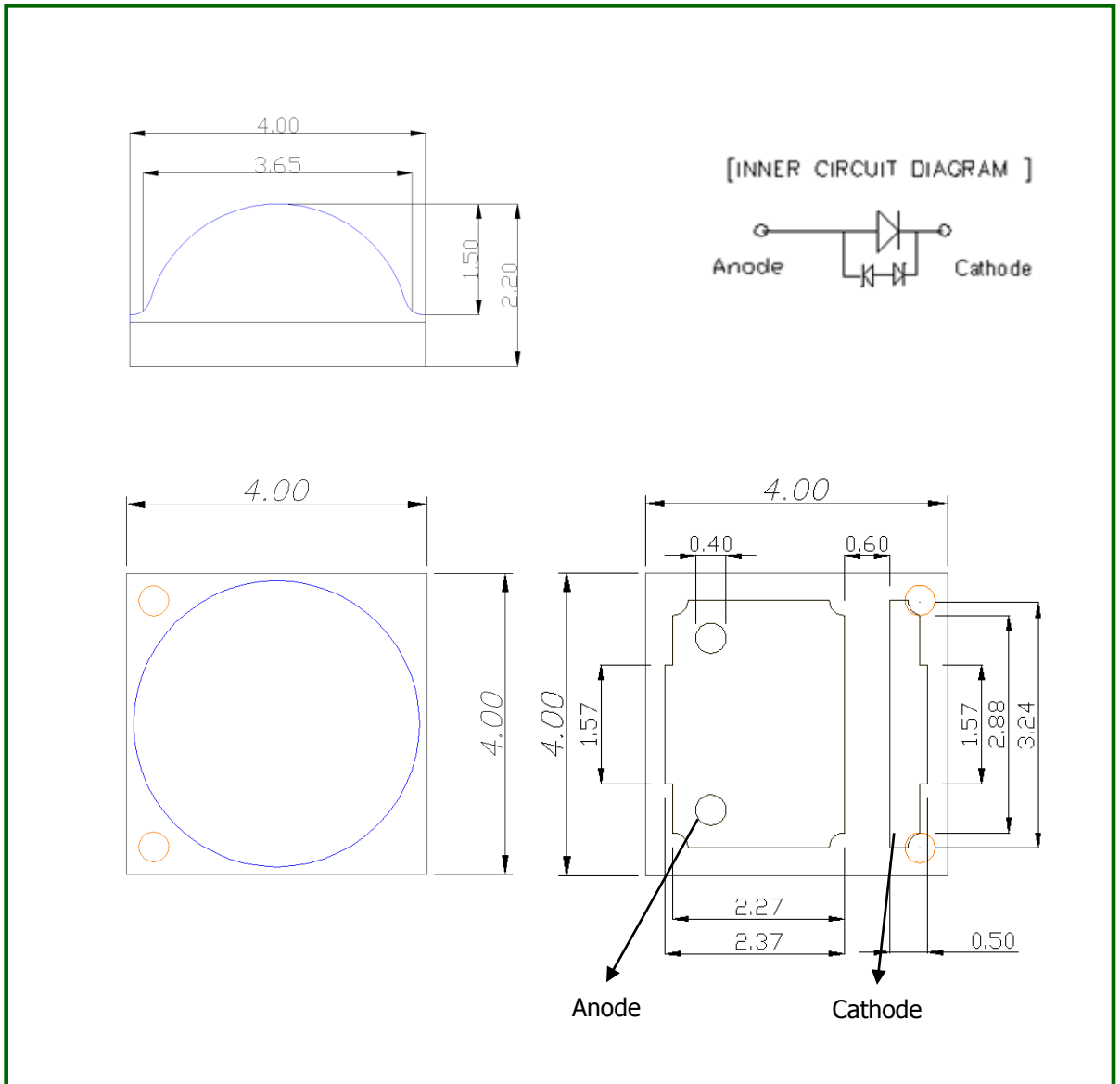

Notes :

- [1] All dimensions are in millimeters. (tolerance is  $\pm 0.20\text{mm}$  )
- [2] Scale : none
- [3] The appearance and specifications of the product may be changed for improvement without notice
- [4] Electrically neutral thermal path

## Characteristics of SAW09H0A

### 1. Cool white

1-1 Electro-Optical characteristics at IF= 20mA, Ta=25°C

Parameter	Symbol	Value			Unit
		Min	Typ	Max	
Luminous Flux [1]	$\Phi_V$ [2]	140	165	-	lm
Correlated Color Temperature [3]	CCT	4,200	-	6,000	K
CRI	$R_a$	69	-	-	-
Forward Voltage	$V_F$	60	64	68	V
Thermal resistance	Rth	6			°C/W
View Angle	2 $\theta$ 1/2	120			deg.

1-2 Absolute Maximum Ratings

Parameter	Symbol	Value	Unit
Forward Current	$I_F$	40	mA
Power Dissipation	$P_D$	2.72	W
Junction Temperature	$T_j$	125	°C
Operating Temperature	$T_{opr}$	-30 ~ +85	°C
Storage Temperature	$T_{stg}$	-40 ~ +110	°C
ESD Sensitivity	-	-	-

\* Notes :

[1] Acrich series maintains a tolerance of  $\pm 10\%$  on flux and power measurements.

[2]  $\Phi_V$  is the total luminous flux output as measured with an integrating sphere.

[3] Correlated Color Temperature is derived from the CIE 1931 Chromaticity diagram.

CCT  $\pm 5\%$  tester tolerance

**Color Spectrum,  $T_A=25^\circ\text{C}$ ,  $IF=20\text{mA}$**

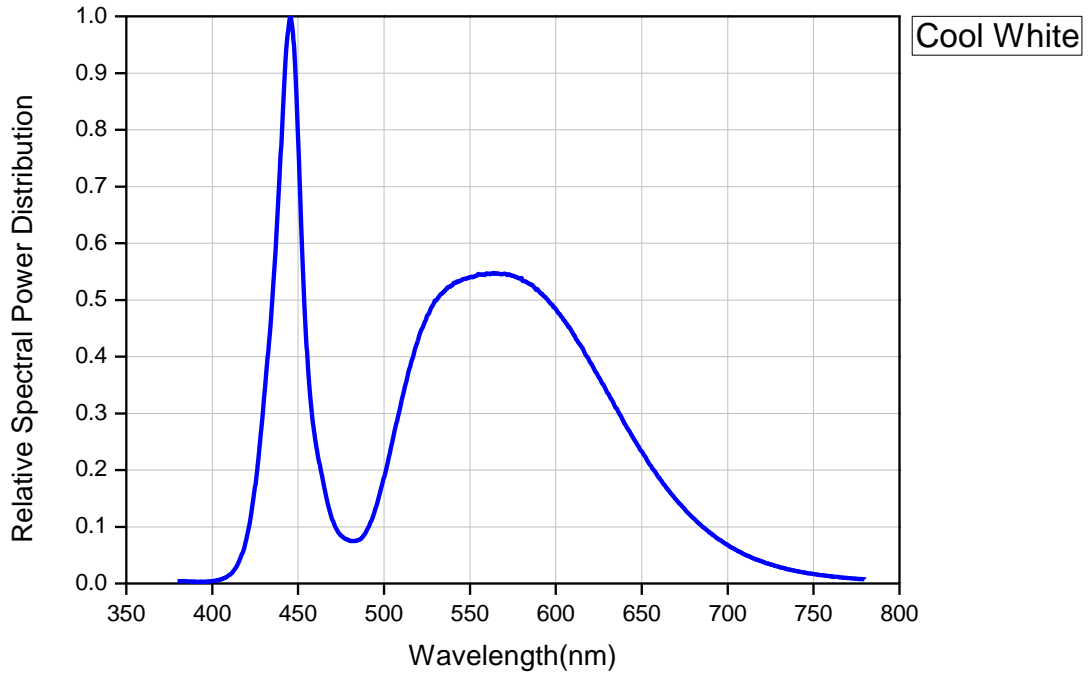

**Radiant pattern,  $T_A=25^\circ\text{C}$ ,  $IF=20\text{mA}$**

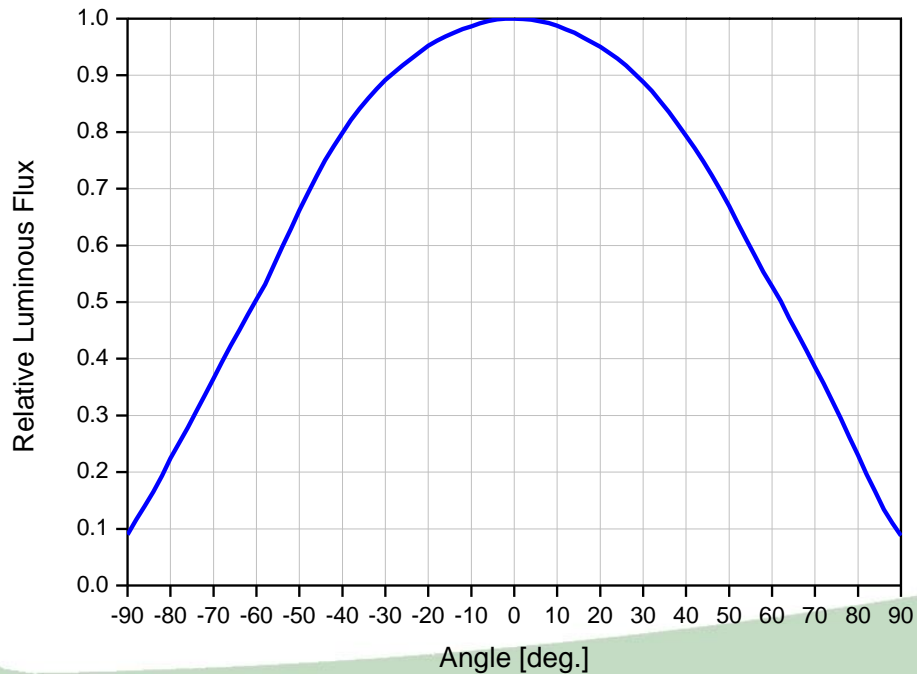

## Forward Current Characteristics

### Forward Voltage vs. Forward Current, $T_a=25^\circ\text{C}$

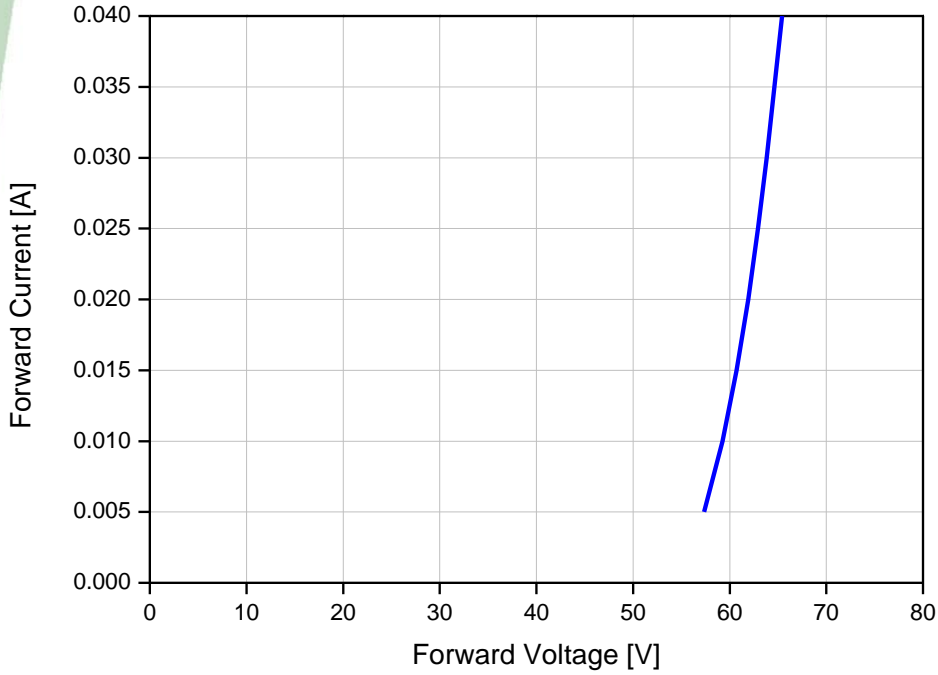

### Forward Current vs. Relative Luminous Flux, $T_a=25^\circ\text{C}$

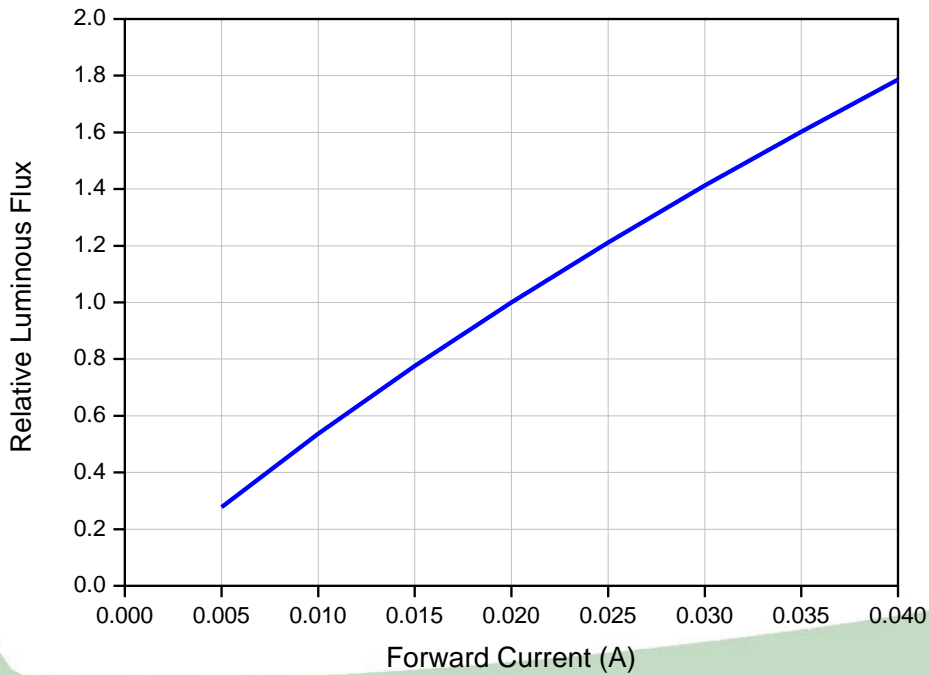

## Forward Current Characteristics

### Forward Current vs. CIE X, Y Shift , Ta=25°C

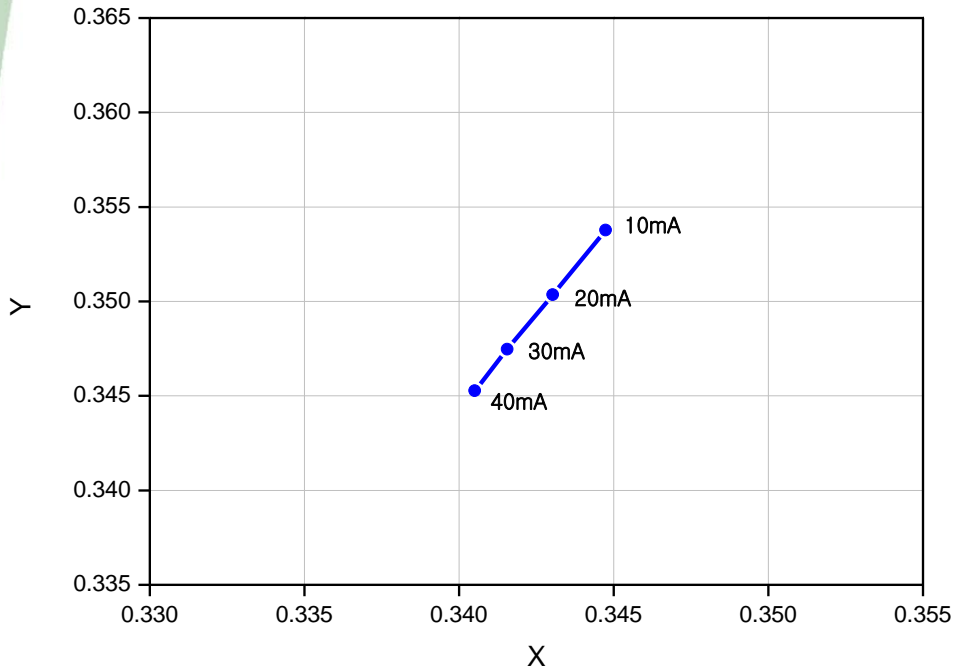



## Junction Temperature Characteristics

Relative Light Output vs. Junction Temperature at IF=20mA

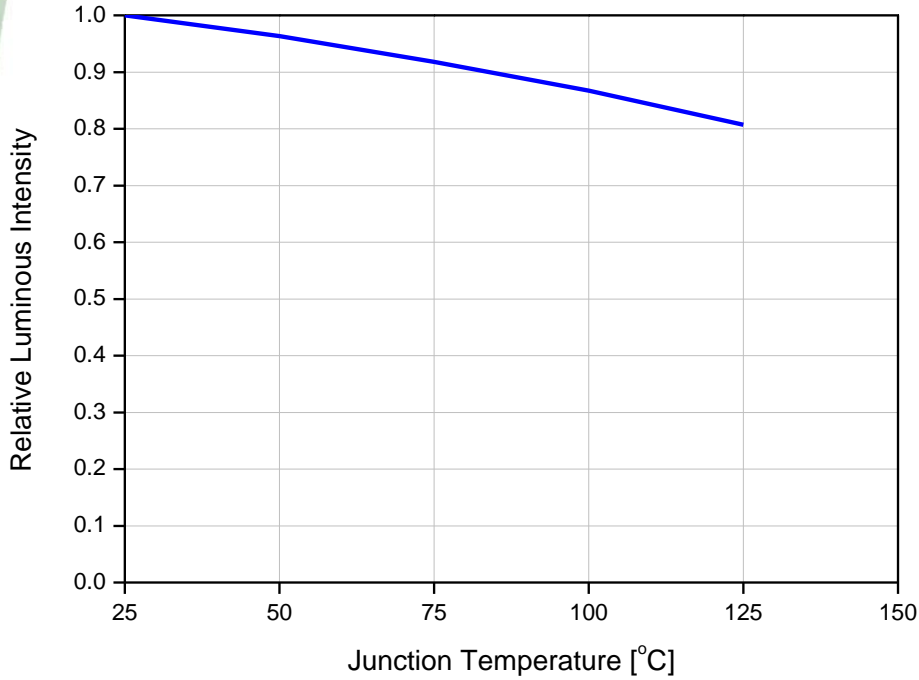

Forward Voltage Shift vs. Junction Temperature at IF=20mA

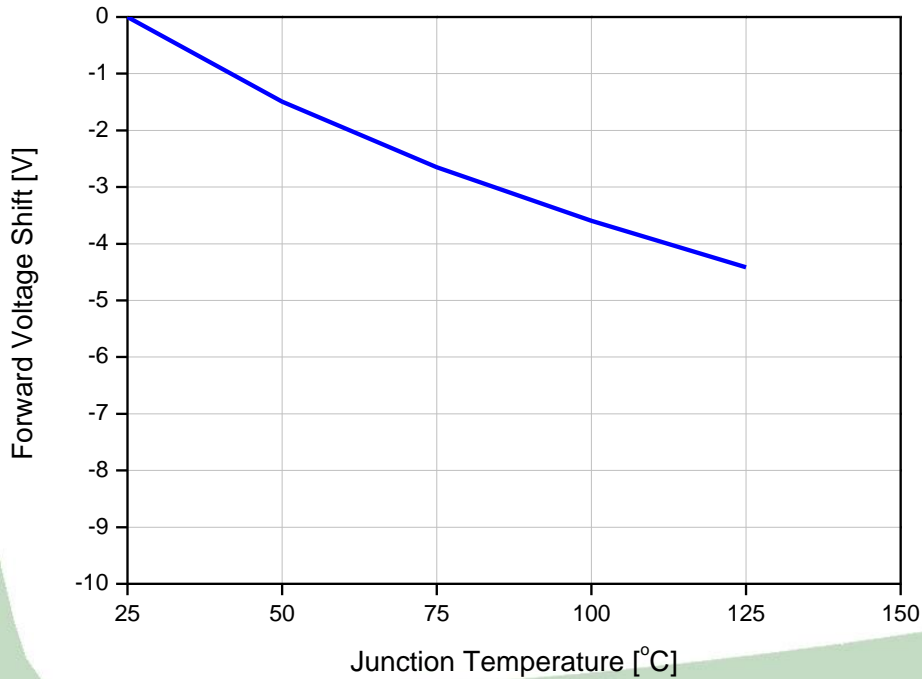

## Junction Temperature Characteristics

### Junction Temp. vs. CIE X, Y Shift, IF=20mA

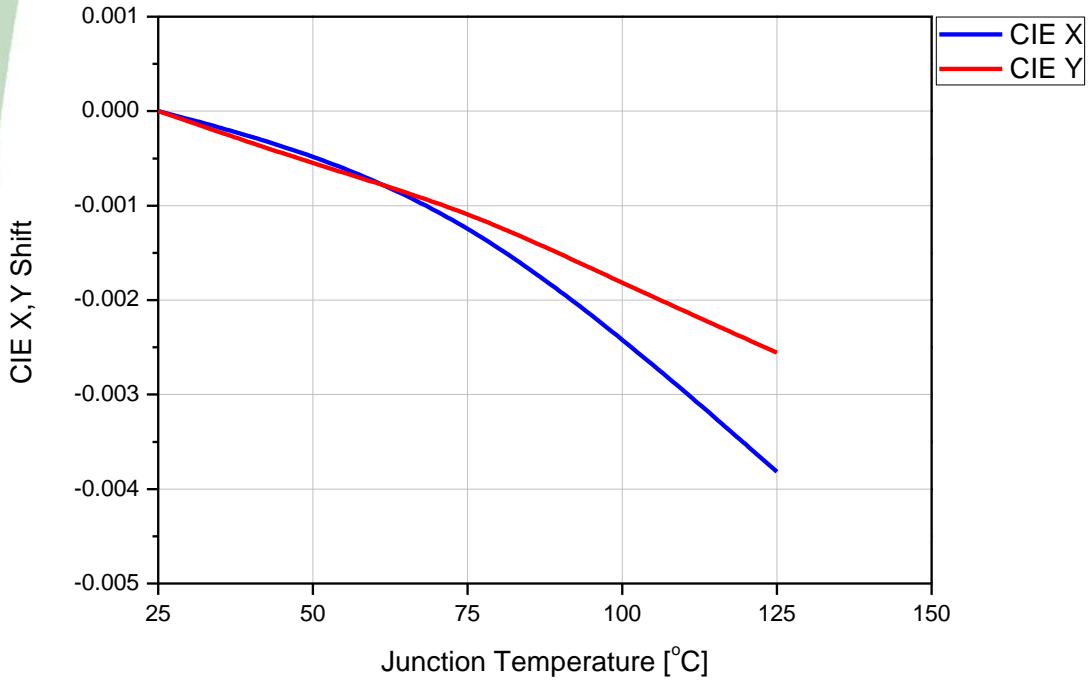

## Maximum Forward Current vs. Ambient Temperature

$T_{jmax} = 125^{\circ}C$ , at 40mA

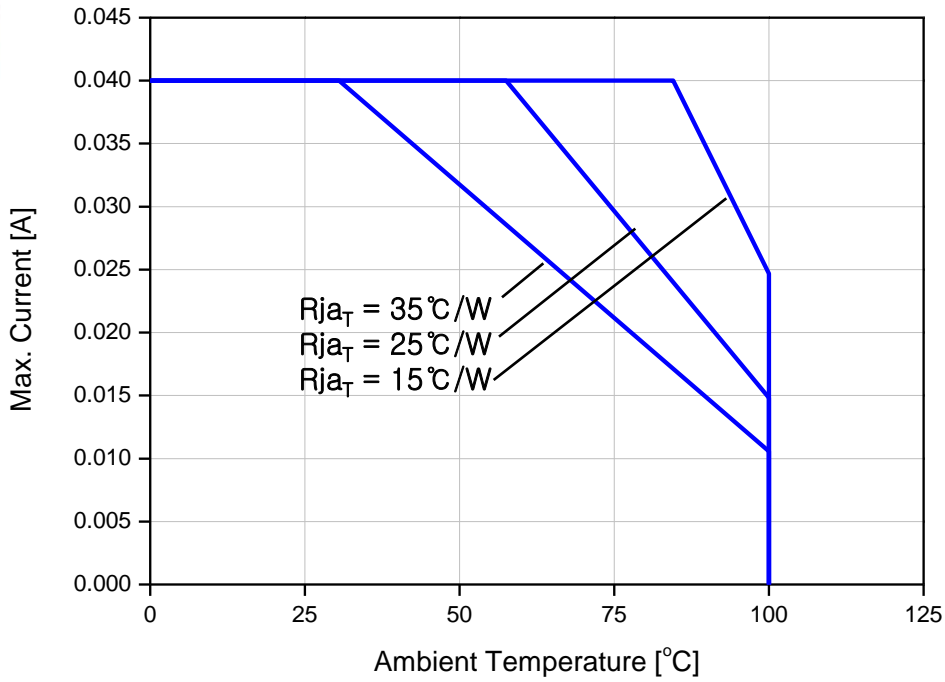

## Color & Binning

### Binning structure graphical representation

< IF=20mA, Ta=25°C >

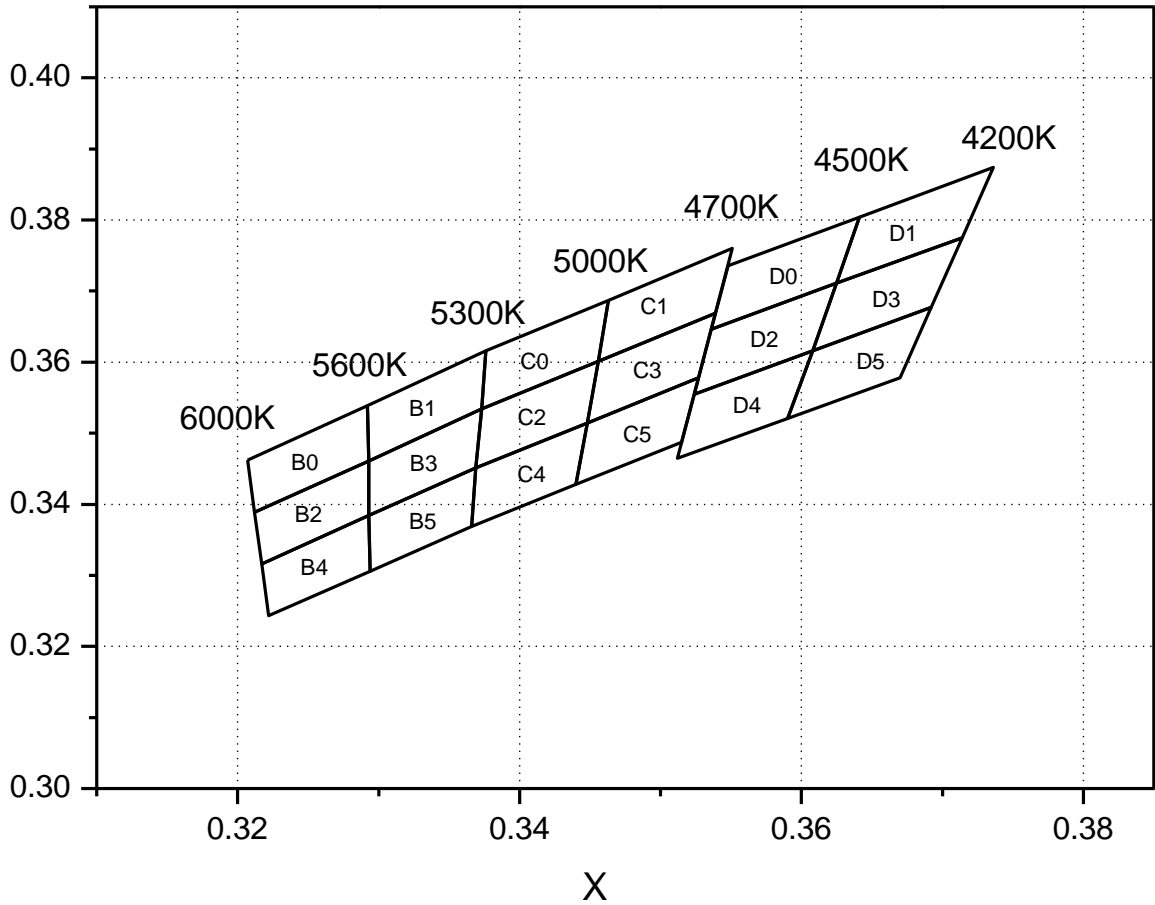

## Color & Binning

● COLOR RANK

< IF=20mA, Ta=25°C >

<b>B0</b>		<b>B1</b>		<b>B2</b>	
CIE X	CIE Y	CIE X	CIE Y	CIE X	CIE Y
0.3207	0.3462	0.3292	0.3539	0.3212	0.3389
0.3212	0.3389	0.3293	0.3461	0.3217	0.3316
0.3293	0.3461	0.3373	0.3534	0.3293	0.3384
0.3292	0.3539	0.3376	0.3616	0.3293	0.3461
<b>B3</b>		<b>B4</b>		<b>B5</b>	
CIE X	CIE Y	CIE X	CIE Y	CIE X	CIE Y
0.3293	0.3461	0.3217	0.3316	0.3293	0.3384
0.3293	0.3384	0.3222	0.3243	0.3294	0.3306
0.3369	0.3451	0.3294	0.3306	0.3366	0.3369
0.3373	0.3534	0.3293	0.3384	0.3369	0.3451
<b>C0</b>		<b>C1</b>		<b>C2</b>	
CIE X	CIE Y	CIE X	CIE Y	CIE X	CIE Y
0.3376	0.3616	0.3463	0.3687	0.3373	0.3534
0.3373	0.3534	0.3456	0.3601	0.3369	0.3451
0.3456	0.3601	0.3539	0.3669	0.3448	0.3514
0.3463	0.3687	0.3552	0.376	0.3456	0.3601
<b>C3</b>		<b>C4</b>		<b>C5</b>	
CIE X	CIE Y	CIE X	CIE Y	CIE X	CIE Y
0.3456	0.3601	0.3369	0.3451	0.3448	0.3514
0.3448	0.3514	0.3366	0.3369	0.344	0.3428
0.3526	0.3578	0.344	0.3428	0.3514	0.3487
0.3539	0.3669	0.3448	0.3514	0.3526	0.3578

## Color & Binning

● COLOR RANK

< IF=20mA, Ta=25°C >

D0		D1		D2	
CIE X	CIE Y	CIE X	CIE Y	CIE X	CIE Y
0.3548	0.3736	0.3641	0.3804	0.3536	0.3646
0.3536	0.3646	0.3625	0.3711	0.3523	0.3555
0.3625	0.3711	0.3714	0.3775	0.3608	0.3616
0.3641	0.3804	0.3736	0.3874	0.3625	0.3711
D3		D4		D5	
CIE X	CIE Y	CIE X	CIE Y	CIE X	CIE Y
0.3625	0.3711	0.3523	0.3555	0.3608	0.3616
0.3608	0.3616	0.3511	0.3465	0.359	0.3521
0.3692	0.3677	0.359	0.3521	0.367	0.3578
0.3714	0.3775	0.3608	0.3616	0.3692	0.3677

## Bin code description

### 1. Luminous Flux Bins

- Luminous flux bin structure for pure white, warm white

• **Example**

BIN CODE : **W2**C0A

└───┬───> Luminous Flux bin

Bin Code	Luminous Flux [lm]
V3	140.0 ~ 154.0
W1	154.0 ~ 165.0
W2	165.0 ~ 177.0
W3	177.0 ~ 200.0

Tolerance : ±10% of Luminous flux value

### 2. Pure White CIE

Pure white product tested and binned by x,y coordinates and CCT

• **Example**

BIN CODE : W2**C0**A

└───┬───> Color bin

### 3. Voltage Bins

• **Example**

BIN CODE : W2C0**A**

└───┬───> Voltage bin

Bin Code	Voltage [V]
A	60~63
B	63~65
C	65~68

## Emitter Carrier & Reel Packaging

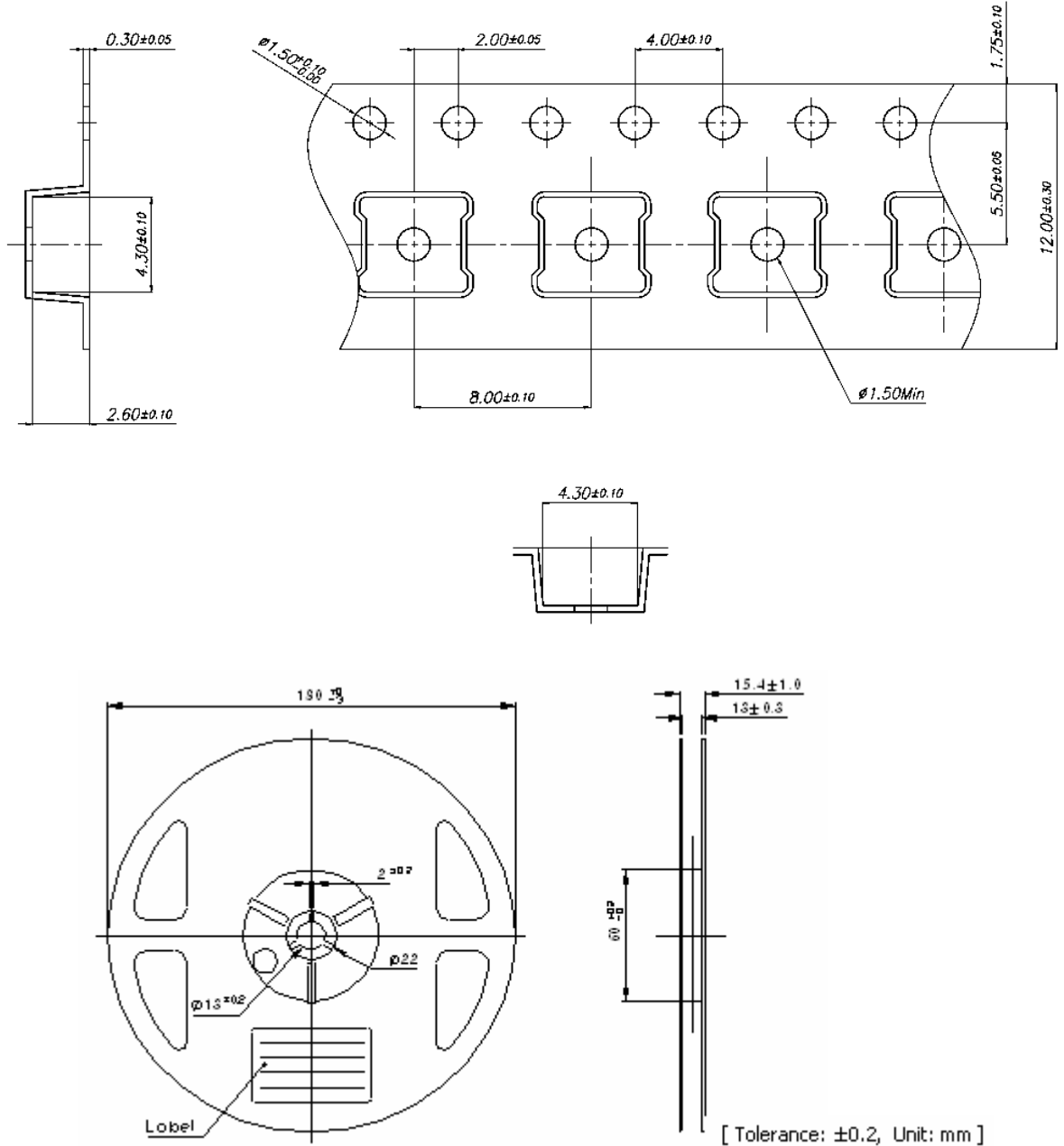

Notes :

- [1] Quantity : 700 pcs/Reel
- [2] Cumulative Tolerance : Cumulative Tolerance/10 pitches to be  $\pm 0.2\text{mm}$
- [3] Adhesion Strength of Cover Tape : Adhesion strength to be 0.1-0.7N when the cover tape is turned off from the carrier tape at the angle of  $10^\circ$  to the carrier tape
- [4] Package : P/N, Manufacturing data Code No. and quantity to be indicated on a damp proof Package

Rev. 02



## Packing

### Reel

RANK: XXXX  
 QUANTITY : XXXX  
 LOT NUMBER : XXXXXXXXXXXX  
 PART NUMBER : XXXXXXXX  
 SEOUL SEMICONDUCTOR CO., LTD.

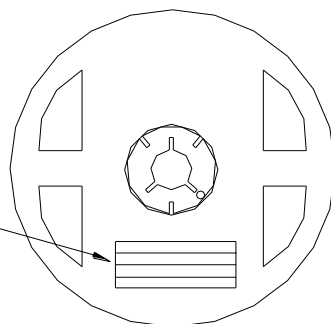

### Aluminum Vinyl Bag

RANK: XXXX  
 QUANTITY : XXXX  
 LOT NUMBER : XXXXXXXXXXXX  
 PART NUMBER : XXXXXXXX  
 SEOUL SEMICONDUCTOR CO., LTD.

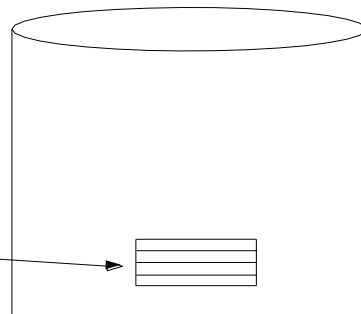

### Outer Box Structure

Material : Paper(SW3B(B))

TYPE	SIZE (mm)		
	a	b	c
7inch	245	220	142

#### ① SIDE

RANK: XXXX  
 QUANTITY : XXXX  
 LOT NUMBER : XXXXXXXXXXXX  
 PART NUMBER : XXXXXXXX  
 SEOUL SEMICONDUCTOR CO., LTD.

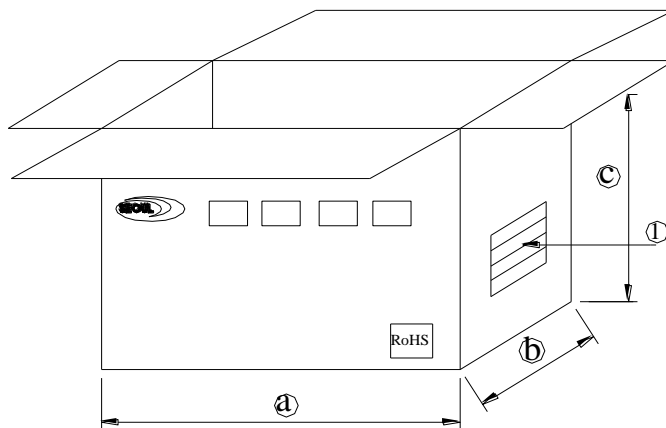

## Soldering

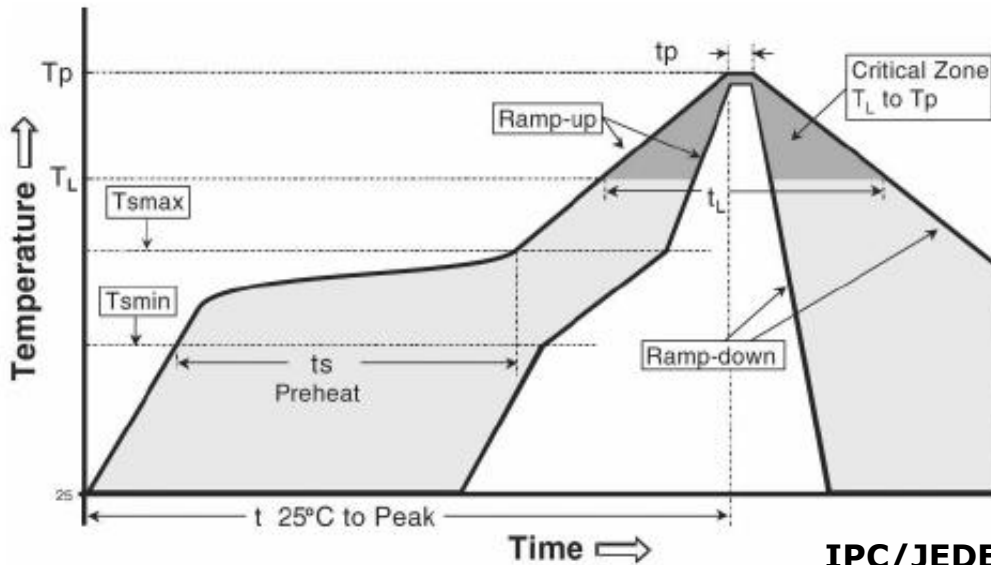

IPC/JEDEC J-STD-020

Profile Feature	Sn-Pb Eutectic Assembly	Pb-Free Assembly
<b>Average ramp-up rate (T<sub>smax</sub> to T<sub>p</sub>)</b>	3° C/second max.	3° C/second max.
<b>Preheat</b> - Temperature Min (T <sub>smin</sub> ) - Temperature Max (T <sub>smax</sub> ) - Time (T <sub>smin</sub> to T <sub>smax</sub> ) (t <sub>s</sub> )	100 °C 150 °C 60-120 seconds	150 °C 200 °C 60-180 seconds
Time maintained above: - Temperature (T <sub>L</sub> ) - Time (t <sub>L</sub> )	183 °C 60-150 seconds	217 °C 60-150 seconds
Peak Temperature (T <sub>p</sub> )	215°C	260°C
Time within 5°C of actual Peak Temperature (t <sub>p</sub> ) <sup>2</sup>	10-30 seconds	20-40 seconds
Ramp-down Rate	6 °C/second max.	6 °C/second max.
Time 25°C to Peak Temperature	6 minutes max.	8 minutes max.

\* Caution

1. Reflow soldering is recommended not to be done more than two times. In the case of more than 24 hours passed soldering after first, LEDs will be damaged.
2. Repairs should not be done after the LEDs have been soldered. When repair is unavoidable, suitable tools must be used.
3. Die slug is to be soldered.
4. When soldering, do not put stress on the LEDs during heating.
5. After soldering, do not warp the circuit board.

## Precaution for use

### (1) Storage

To avoid the moisture penetration, we recommend store in a dry box with a desiccant . The recommended storage temperature range is 5℃ to 30℃ and a maximum humidity of RH50%.

### (2) Use Precaution after Opening the Packaging

Use proper SMD techniques when the LED is to be soldered dipped as separation of the lens may affect the light output efficiency.

Pay attention to the following:

#### a. Recommend conditions after opening the package

- Sealing
- Temperature : 5 ~ 40℃ Humidity : less than RH30%

b. If the package has been opened more than 4 week(MSL\_2a) or the color of the desiccant changes, components should be dried for 10-12hr at 60±5℃

(3) Do not apply mechanical force or excess vibration during the cooling process to normal temperature after soldering.

(4) Do not rapidly cool device after soldering.

(5) Components should not be mounted on warped (non coplanar) portion of PCB.

(6) Radioactive exposure is not considered for the products listed here in.

(7) Gallium arsenide is used in some of the products listed in this publication. These products are dangerous if they are burned or shredded in the process of disposal. It is also dangerous to drink the liquid or inhale the gas generated by such products when chemically disposed of.

(8) This device should not be used in any type of fluid such as water, oil, organic solvent and etc. When washing is required, IPA (Isopropyl Alcohol) should be used.

(9) When the LEDs are in operation the maximum current should be decided after measuring the package temperature.

(10) LEDs must be stored properly to maintain the device. If the LEDs are stored for 3 months or more after being shipped from SSC, a sealed container with a nitrogen atmosphere should be used for storage.

(11) The appearance and specifications of the product may be modified for improvement without notice.

(12) Long time exposure of sunlight or occasional UV exposure will cause lens discoloration.

(13) VOCs (Volatile organic compounds) emitted from materials used in the construction of fixtures can penetrate silicone encapsulants of LEDs and discolor when exposed to heat and photonic energy. The result can be a significant loss of light output from the fixture.

Knowledge of the properties of the materials selected to be used in the construction of fixtures can help prevent these issues.

(14)Attaching LEDs, do not use adhesives that outgas organic vapor.

(15)The driving circuit must be designed to allow forward voltage only when it is ON or OFF.

If the reverse voltage is applied to LED, migration can be generated resulting in LED damage.

- (16) Please note Acrich runs on high voltage so use caution when near the leads or if a dome is inadvertently removed while circuit is active.
- (17) Please do not touch any of the circuit board, components or terminals with bare hands or metal while circuit is electrically active.
- (18) Please do not add or change wires while Acrich circuit is active.

## Handling of Silicone Resin LEDs

(1) During processing, mechanical stress on the surface should be minimized as much as possible. Sharp objects of all types should not be used to pierce the sealing compound.



(2) In general, LEDs should only be handled from the side. By the way, this also applies to LEDs without a silicone sealant, since the surface can also become scratched.

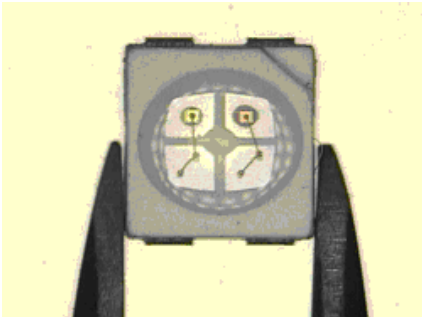

(3) When populating boards in SMT production, there are basically no restrictions regarding the form of the pick and place nozzle, except that mechanical pressure on the surface of the resin must be prevented.

This is assured by choosing a pick and place nozzle which is larger than the LED's reflector area.

(4) Silicone differs from materials conventionally used for the manufacturing of LEDs. These conditions must be considered during the handling of such devices. Compared to standard encapsulants, silicone is generally softer, and the surface is more likely to attract dust.

As mentioned previously, the increased sensitivity to dust requires special care during processing. In cases where a minimal level of dirt and dust particles cannot be guaranteed, a suitable cleaning solution must be applied to the surface after the soldering of components.

(5) SSC suggests using isopropyl alcohol for cleaning. In case other solvents are used, it must be assured that these solvents do not dissolve the package or resin.

Ultrasonic cleaning is not recommended. Ultrasonic cleaning may cause damage to the LED.

(6) Please do not mold this product into another resin (epoxy, urethane, etc) and do not handle this product with acid or sulfur material in sealed space.

(7) Avoid leaving fingerprints on silicone resin parts.

## X-ON Electronics

Largest Supplier of Electrical and Electronic Components

*Click to view similar products for [Standard LEDs - SMD category](#):*

*Click to view products by [Seoul Semiconductor manufacturer](#):*

Other Similar products are found below :

[LTST-C190KYKT](#) [LTST-C19GD2WT](#) [LTST-N683GBEW](#) [LTW-170ZDC](#) [LTW-M140SZS40](#) [598-8110-100F](#) [598-8170-100F](#) [598-8610-202F](#) [67-22VRVGC/TR8](#) [AAAF5060QBFSEEZGS](#) [HLMA-QG00-S0021](#) [HLMP-6305-L0011](#) [ALMD-LB36-SV002](#) [APT1608QGWW](#) [15-21UYC/S530-A3/TR8](#) [EAST2012YA0](#) [EASV1803BA0](#) [LG M67K-H1J2-24-0-2-R18-Z](#) [LS A676-P2S1-1](#) [SML310BATT86](#) [SML-512VWT86A](#) [SML-LX0606SISUGC/A](#) [SML-LXL1307SRC-TR](#) [SML-LXR851SIUPGUBC](#) [LT1ED53A](#) [FAT801-S](#) [AM27ZGC03](#) [APB3025SGNC](#) [APFA3010SURKCGKQBDC](#) [APHK1608VGCA](#) [APT2012QGWW](#) [CLX6D-FKB-CN1R1H1BB7D3D3](#) [LTST-C250KGKT](#) [LTW-020ZDCG](#) [LTW-21TS5](#) [LTW-220DS5](#) [JANTXM19500/521-02](#) [UYGT801-S](#) [42-21UYC/S530-A3/TR8](#) [LO T67F-V1AB-24-1](#) [YGFR411-H](#) [598-8330-117F](#) [SML-LX0402IC-TR](#) [CMDA20AYAA7D1S](#) [CMDA16AYDR7A1X](#) [598-8040-100F](#) [598-8070-100F](#) [598-8140-100F](#) [598-8610-200F](#) [EAST2012GA0](#)