



Specification

SFT722N-S

SSC		Customer
Drawn	Approval	Approval

Contents

1. Feature & Application
2. Absolute Maximum Ratings .
3. Electro Characteristics
4. Optical characteristics
5. Color & Binning
6. Rank of SFT722N-S
7. Outline Dimension
8. Packing
9. Lot Number
10. Soldering
11. Precaution for use
12. Reliability Test Item and Condition

SFT722N-S

SFT722N-S

Description

This surface-mount LED comes in PLCC standard package dimension. It has a substrate made up of a molded plastic reflector sitting on top of a bent lead frame. The die is attached within the reflector cavity and the cavity is encapsulated by epoxy or silicone.

The package design coupled with careful selection of component materials allow these products to perform with high reliability in a larger temperature range -40 °C to 100 °C. The high reliability feature is crucial to Automotive interior and Indoor ESS.



Features

- Pb-free Reflow Soldering application
- RoHS Compliant
- 6-Pin (R,G,B separate) type
- White colored SMT package
- Suitable for all SMT assembly methods
- ESD-withstand voltage : up to 2 kV (MIL-STD-883D)
- Encapsulating Resin : silicone resin
- High Reliability (silicone resin)

Applications

- Indoor and outdoor displays
- LCD Backlights etc.
- R G B –displays
- Automotive
- Signage and Channel letter
- Indicator

2. Absolute maximum ratings

(Ta=25°C)

Parameter	Symbol	Value			Unit
		Red	Green	Blue	
Forward Current	I_F	30	30	30	mA
Forward Peak Surge Current *2	I_{FM}	100	100	100	mA
Reverse Voltage (per die)	V_R	5			V
Power Dissipation	P_d	81*3	120*3	114*3	mW
		263*4			
Operating Temperature	T_{opr}	-40 ~ +100			°C
Storage Temperature	T_{stg}	-40 ~ +100			°C

*1 Care is to be taken that power dissipation does not exceed the absolute maximum rating of the product.

*2 IFM was measured at $TW \leq 1\text{msec}$ of pulse width and $D \leq 1/10$ of duty ratio.

*3 The value for one LED device.(Single color)

*4 The value for total power dissipation when two and more devices are lit simultaneously.

3. Electric & Optical characteristics

(Ta=25°C)

Parameter		Symbol	Condition	Min	Typ	Max	Unit
Forward Voltage	Red	V_F	$I_F = 20\text{mA}$	1.8	2.1	2.3	V
	Green		$I_F = 20\text{mA}$	3.0	3.2	3.8	
	Blue		$I_F = 20\text{mA}$	3.0	3.2	3.6	
Reverse Current	Red	I_R	$V_R = 10\text{V}$ (per die)	-	-	1	μA
	Green			-	-	1	
	Blue			-	-	1	
Luminance Intensity *1	Red	I_V	$I_F = 20\text{mA}$ (per chip)	-	700	1100	mcd
	Green			-	1200	1600	
	Blue			-	200	560	
Luminance Flux	Red	Φ_V	$I_F = 20\text{mA}$ (per chip)	-	1.7	-	lm
	Green			-	3	-	
	Blue			-	1	-	
Peak Wavelength	Red	λ_p	$I_F = 20\text{mA}$	-	632	-	nm
	Green		$I_F = 20\text{mA}$	-	518	-	
	Blue		$I_F = 20\text{mA}$	-	453	-	
Dominant Wavelength	Red	λ_d	$I_F = 20\text{mA}$	620	623	625	nm
	Green		$I_F = 20\text{mA}$	520	527	535	
	Blue		$I_F = 20\text{mA}$	455	460	465	
Spectral Bandwidth	Red	$\Delta\lambda$	$I_F = 20\text{mA}$	-	14	-	nm
	Green		$I_F = 20\text{mA}$	-	33	-	
	Blue		$I_F = 20\text{mA}$	-	23	-	
Viewing Angle *3	R, G, B	$2\theta_{1/2}$	$I_F = 20\text{mA}$ (per die)	-	120	-	deg.
Optical Efficiency	Red	η_{op}	$I_F = 20\text{mA}$ (per chip)	-	41	-	lm/W
	Green			-	47	-	
	Blue			-	16	-	
Thermal Resistance (one chip on)	Red	R_{thja}	$I_F = 20\text{mA}$	-	157	-	K/W
	Green		$I_F = 20\text{mA}$	-	177	-	
	Blue		$I_F = 20\text{mA}$	-	186	-	

*1 The luminous intensity I_V was measured at the peak of the spatial pattern which may not be aligned with the mechanical axis of the LED package.

Luminous Intensity Measurement allowance is $\pm 10\%$

*2 Please refer to CIE 1931 chromaticity diagram

*3 $2\theta_{1/2}$ is the off-axis where the luminous intensity is 1/2 of the peak intensity.

[Note] All measurements were made under the standardized environment of SSC.

Rev. 05

September 2009

www.ZLED.com

서식번호 : SSC-QP-7-07-24 (Rev.04)

4. Optical characteristics

Forward Current vs. Forward Voltage (per die)

($T_j=25\text{ }^\circ\text{C}$)

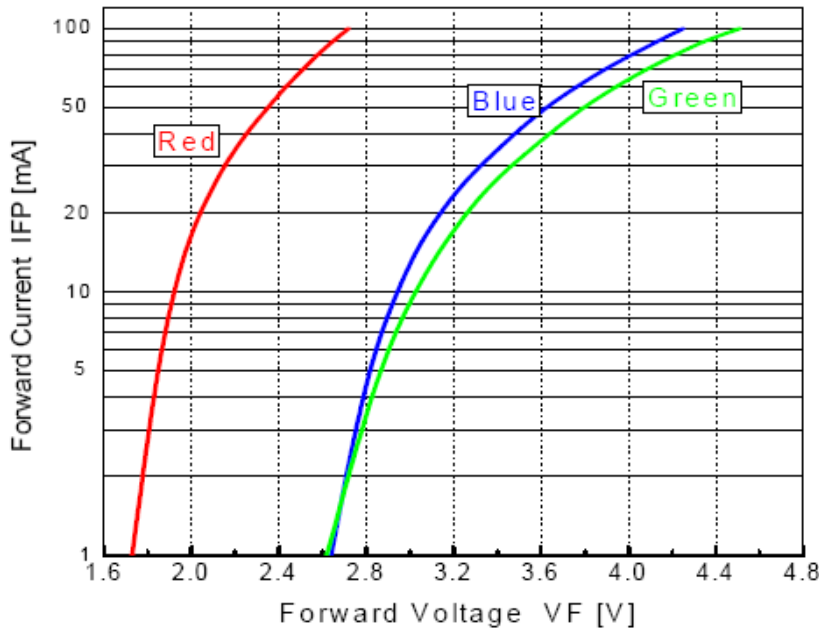

Relative Luminous Intensity vs Forward Current

($T_j=25\text{ }^\circ\text{C}$)

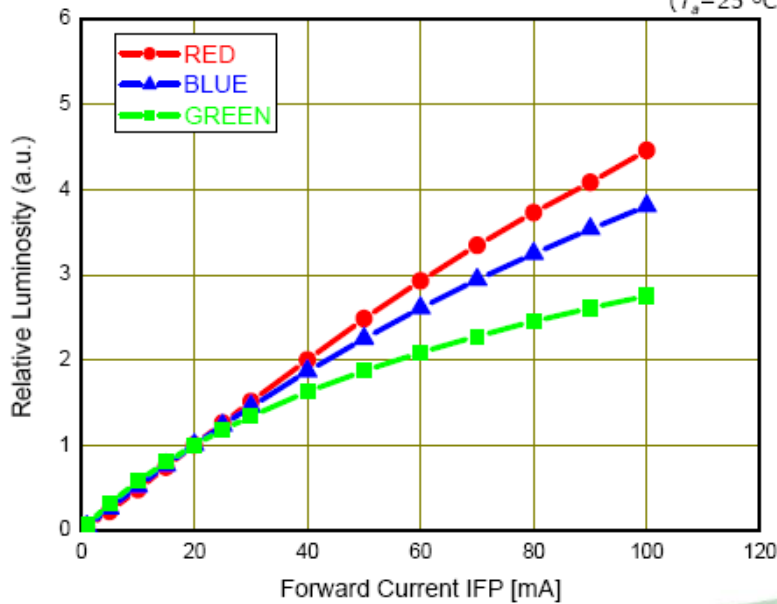

4. Optical characteristics

Ambient Temperature vs. Power Dissipation

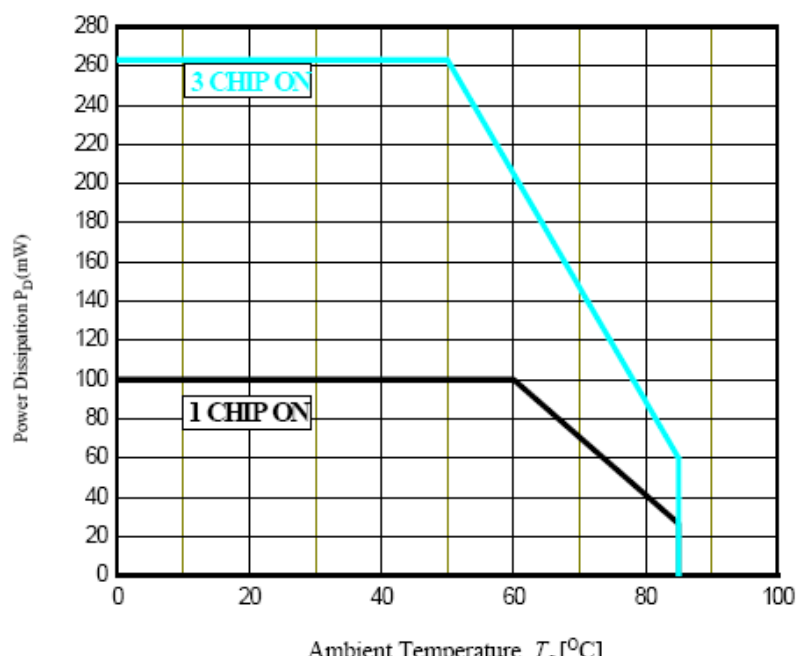

Radiation Diagram

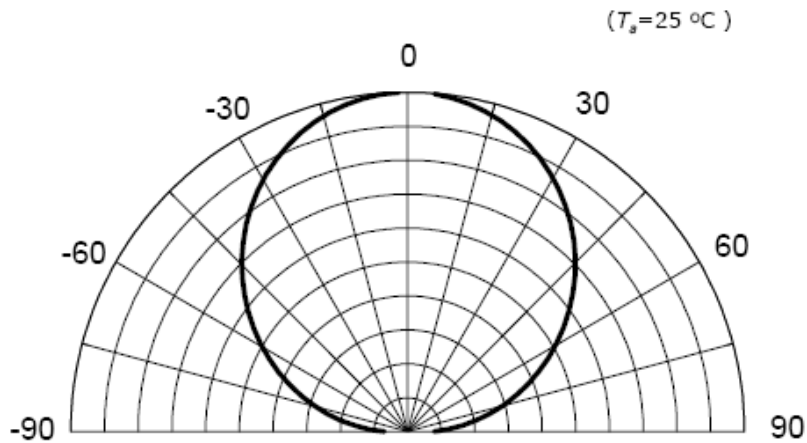

4. Optical characteristics

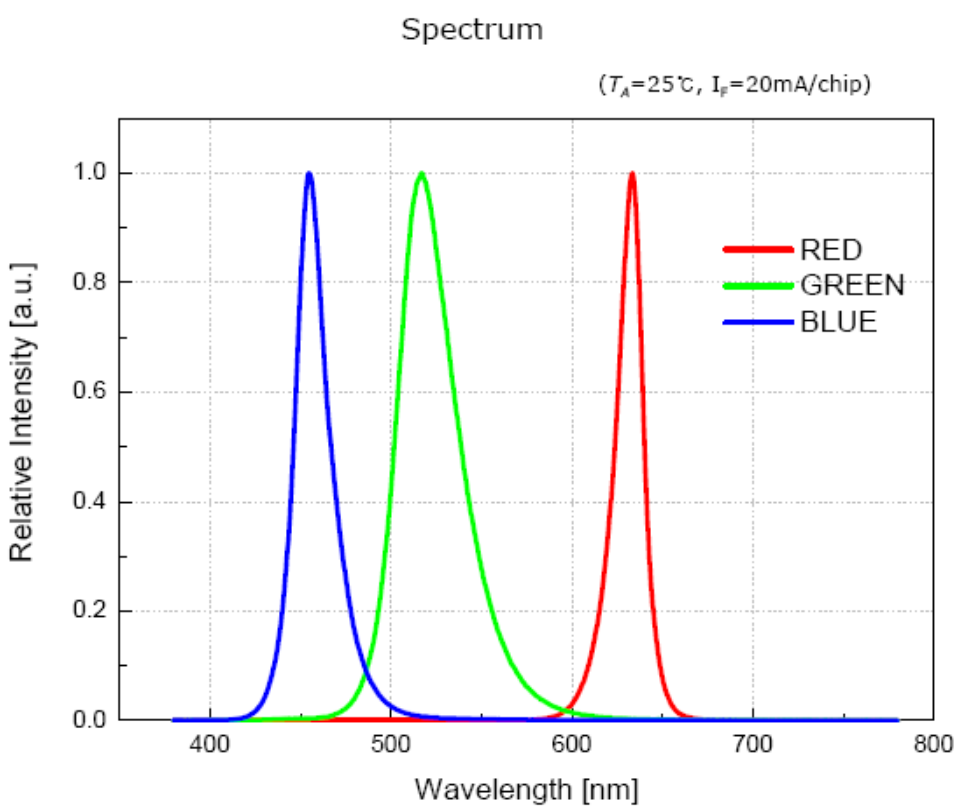

5. Color & Binning

1) RGB Balance

Red		Green : A		Green : B		Blue : 1		Blue : 2	
x	y	x	y	x	y	x	y	x	y
0.690	0.300	0.166	0.677	0.201	0.687	0.153	0.022	0.143	0.031
0.706	0.298	0.201	0.687	0.236	0.685	0.164	0.039	0.155	0.050
0.692	0.312	0.176	0.749	0.220	0.744	0.155	0.050	0.148	0.065
0.678	0.312	0.137	0.739	0.176	0.749	0.143	0.031	0.134	0.044

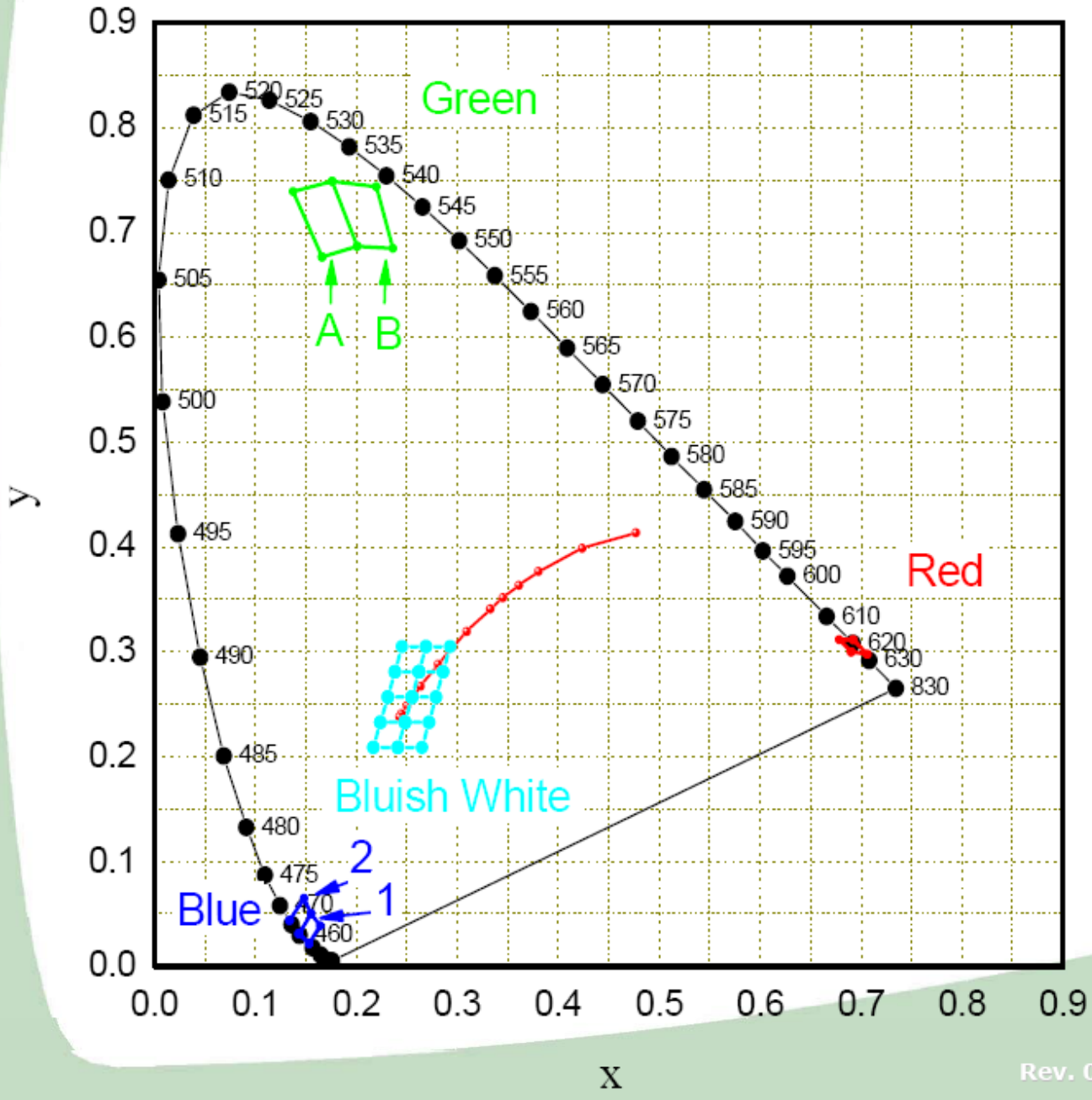

5. Color & Binning

2) White Balance

- ◆ Target of Color : Bluish White (Cool White)
- Color Coordinates (typ.): x 0.255 , y 0.257
- I_f Condition = 12mA for Red / 20mA for Green / 12mA for Blue
- 1 Bin, Cell Size = x 0.025 , y 0.031
- 9 Bin, Total Cell Size = x 0.052 , y 0.112
- Color Rank : a, b, c, d, e, f, g, h (8 BIN)

a		b		c		d		e	
x	y	x	y	x	y	x	y	x	y
0.217	0.209	0.241	0.209	0.224	0.233	0.248	0.233	0.231	0.257
0.241	0.209	0.265	0.209	0.248	0.233	0.272	0.233	0.255	0.257
0.248	0.233	0.272	0.233	0.255	0.257	0.279	0.257	0.262	0.281
0.224	0.233	0.248	0.233	0.231	0.257	0.255	0.257	0.238	0.281

f		g		h	
x	y	x	y	x	y
0.255	0.257	0.238	0.281	0.262	0.281
0.279	0.257	0.262	0.281	0.286	0.281
0.286	0.281	0.269	0.305	0.293	0.305
0.262	0.281	0.245	0.305	0.269	0.305

● Measurement Uncertainty of the Color Coordinates : ± 0.01

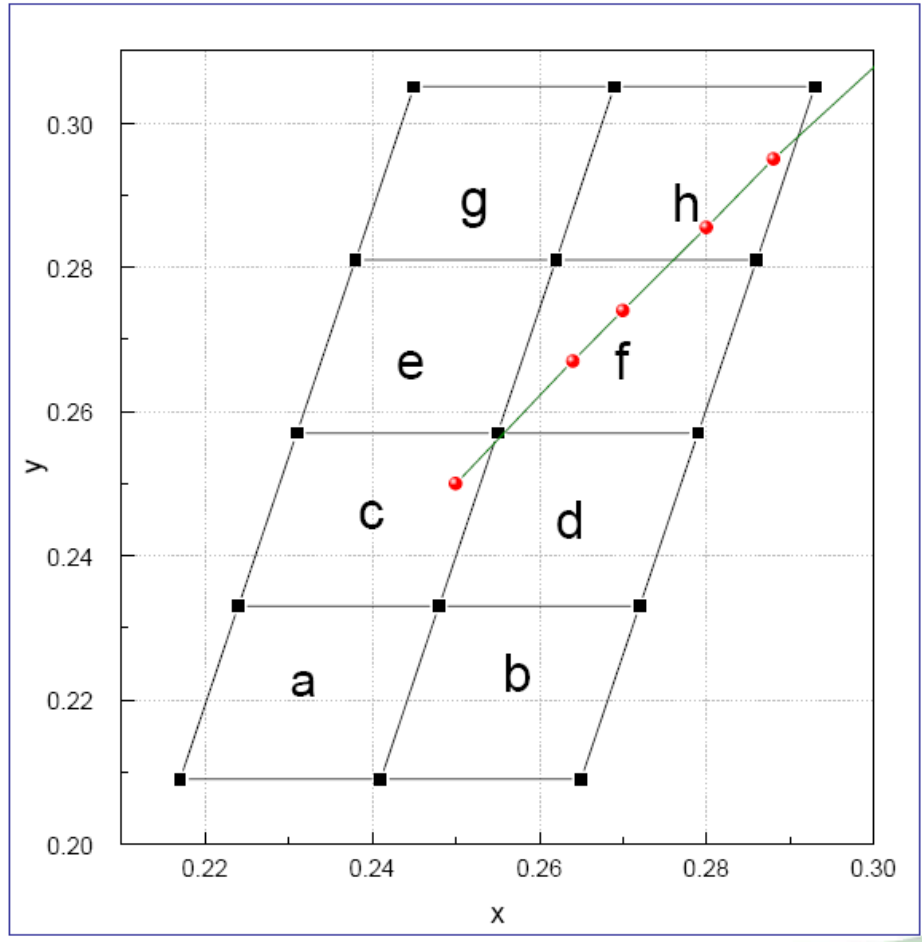

6. Rank of SFT722N-S

1) Rank Name

X ₁	X ₂	X ₃	X ₄
Total Iv	Green Color	Blue Color	White Color

2) Test Condition

Parameter	Symbol	Value			Unit
		R	G	B	
Forward Current	I _f	20	20	20	mA
Reverse Voltage	V _r	10	10	10	V

3) Luminous Intensity [Iv]

R		G		B	
MIN	MAX	MIN	MAX	MIN	MAX
460	1100	800	1600	200	560

Rank Name	Total Iv		Unit
	MIN	MAX	
N	1460	1900	mcd
O	1900	2500	
P	2500	2880	

4) Forward Voltage [V_f]

R		G		B		Unit
MIN	MAX	MIN	MAX	MIN	MAX	
1.8	2.3	3.0	3.8	3.0	3.6	V

5) Reverse Current [I_r]

R		G		B		Unit
MIN	MAX	MIN	MAX	MIN	MAX	
-	1	-	1	-	1	uA

[Note] All measurements were made under the standardized environment of SSC.
In order to ensure availability, single color rank will not be orderable.

7.Outline Dimension

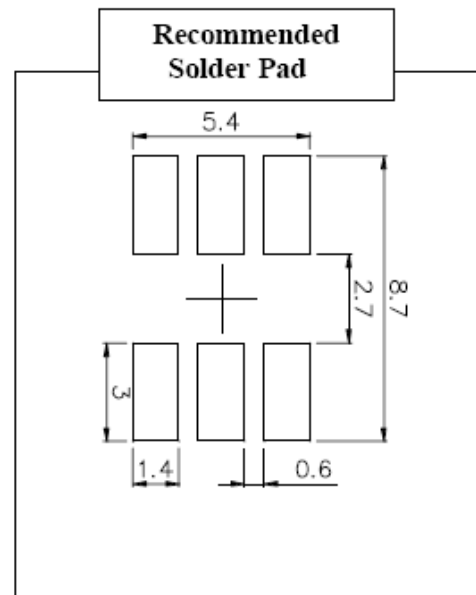
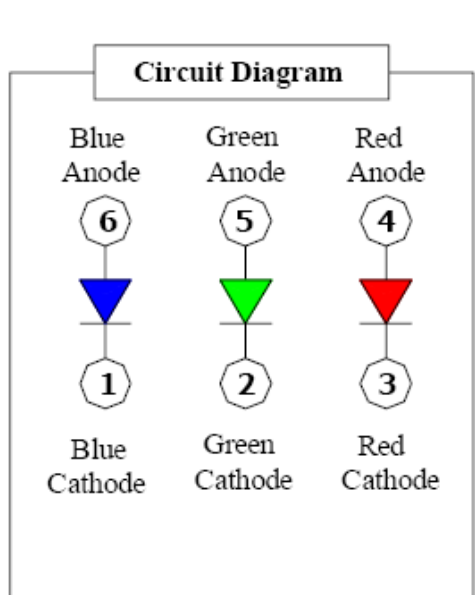
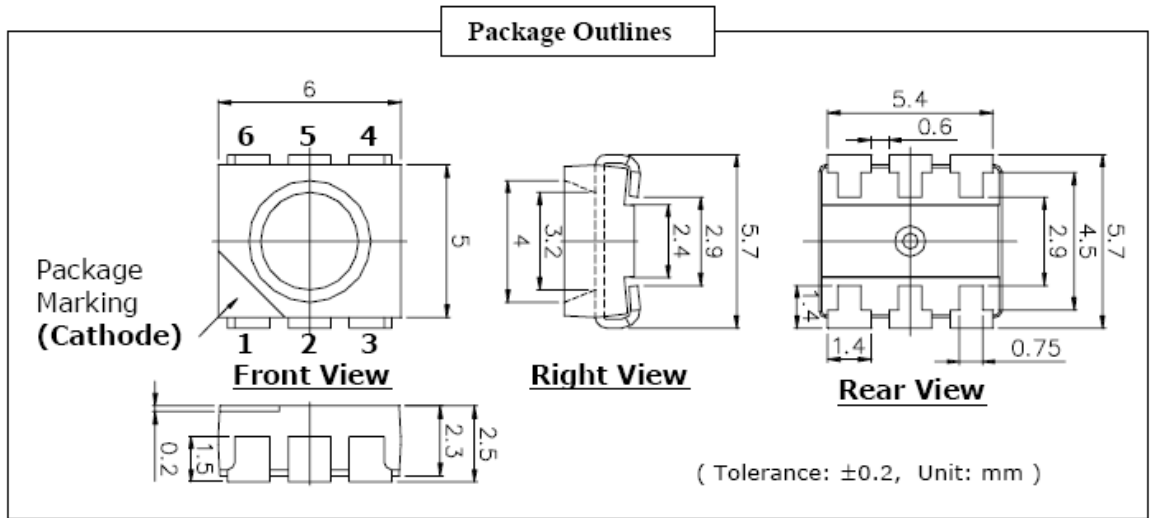

* MATERIALS

PARTS	MATERIALS
Package	Heat-Resistant Polymer
Encapsulating Resin	Silicone Resin
Electrodes	Ag Plating Copper Alloy

8. Packing

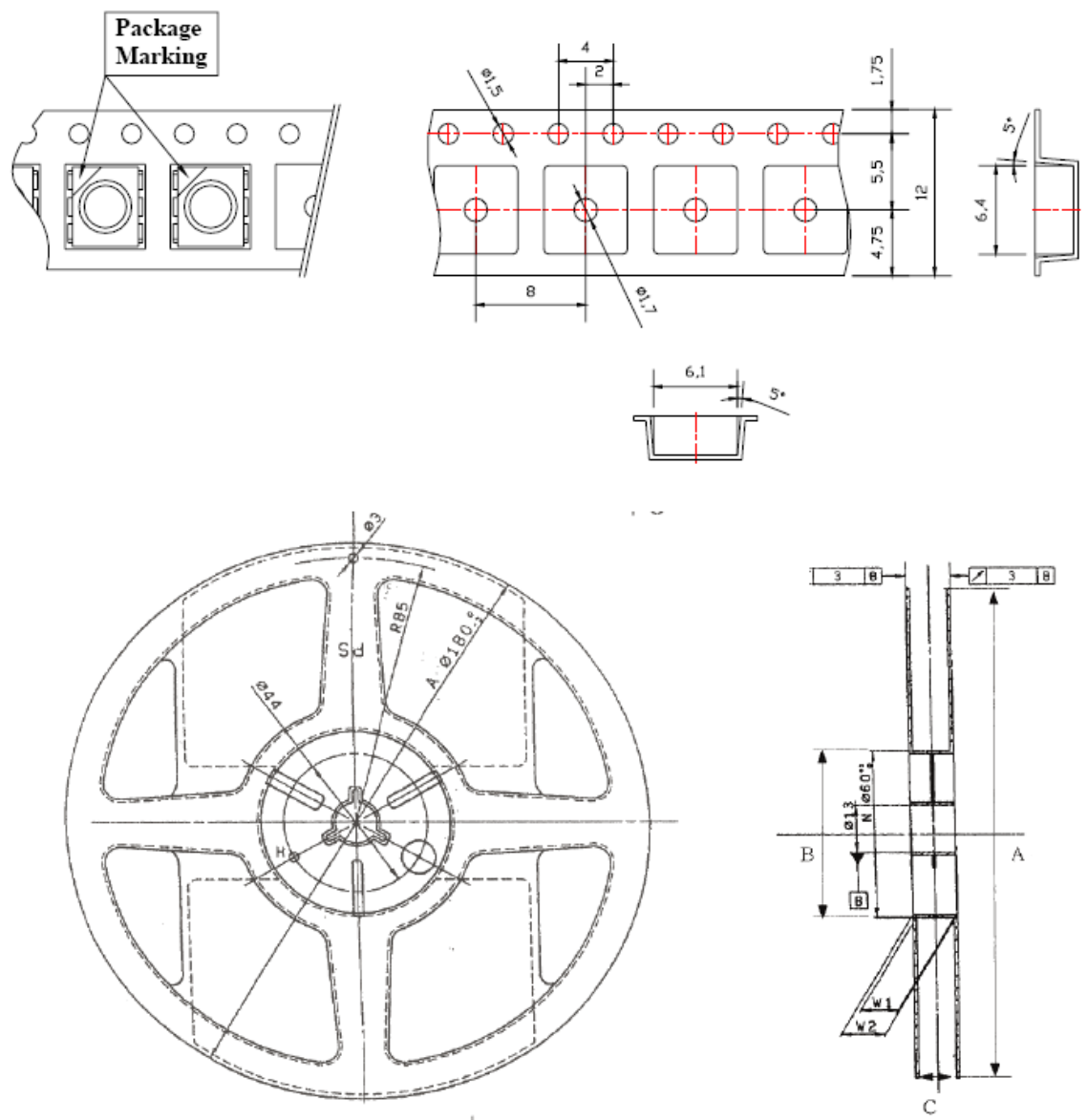

(Tolerance: ± 0.2 , Unit: mm)

- (1)Quantity : 700 pcs/Reel
- (2)Cumulative Tolerance : Cumulative Tolerance/10 pitches to be ± 0.2 mm
- (3)Adhesion Strength of Cover Tape : Adhesion strength to be 0.1-0.7N when the cover tape is turned off from the carrier tape at the angle of 10° to the carrier tape
- (4)Package : P/N, Manufacturing data Code No. and quantity to be indicated on a damp proof Package

● Reel Packing Structure

Reel

RANK: XXX
 QUANTITY: XXXX
 LOT NUMBER: XXXXXXXXXXXX
 PART NUMBER: XXXXXX
 SEOUL SEMICONDUCTOR CO., LTD.

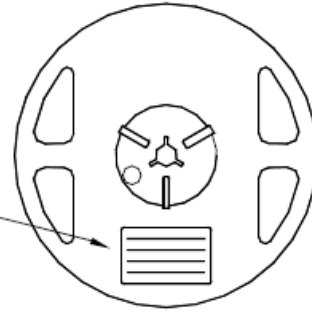

Aluminum Vinyl Bag

RANK: XXX
 QUANTITY: XXXX
 LOT NUMBER: XXXXXXXXXXXX
 PART NUMBER: XXXXXX
 SEOUL SEMICONDUCTOR CO., LTD.

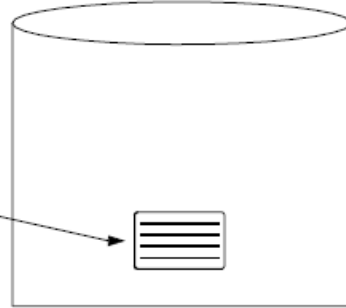

Outer Box Structure

Material : Paper(SW3B(B))

TYPE	SIZE (mm)		
	a	b	c
7inch	245	220	102
	245	220	142

① SIDE

RANK: XXX
 QUANTITY: XXXX
 LOT NUMBER: XXXXXXXXXXXX
 PART NUMBER: XXXXXX
 SEOUL SEMICONDUCTOR CO., LTD.

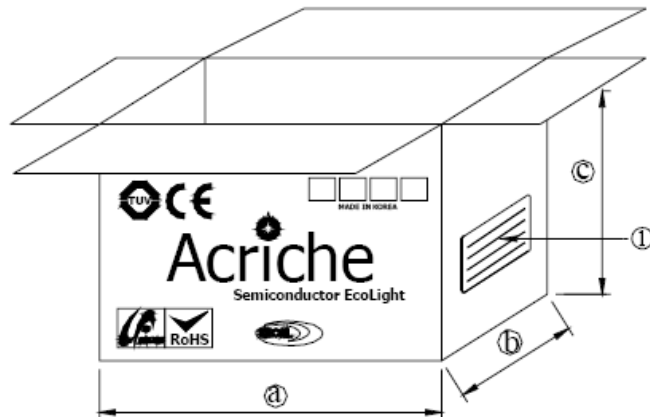

9. Lot Number

The lot number is composed of the following characters;

SFT□□◎◎ # ~ #

SFT -First Part Name

○ - Year (6 for 2006, 7 for 2007, 8 for 2008)

□□ - Month (01 for Jan., 02 for Feb.,11 for Nov., 12 for Dec.)

◎◎ - Day (01, 02, 03, 04,28, 29, 30, 31.)

~# - The number of the internal quality control

RANK: **XXX**

|||||

QUANTITY : 700

||||| ||||| ||||| |||||

LOT NUMBER : SFT70426 01 512

||| ||||| ||||| ||||| ||||| |||||

PART NUMBER : SFT722N-S

||| ||||| ||||| |||||

 SEOUL SEMICONDUCTOR CO., LTD.

10. Soldering

(1) Reflow Soldering Conditions / Profile

Lead Solder	
Pre-heat	130~210℃
Pre-heat time	120 sec. Max.
Peak-Temperature	240℃ Max.
Soldering time Condition	10 sec. Max.

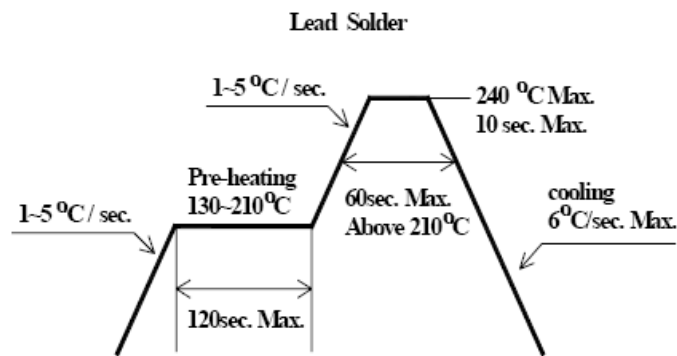

Lead Free Solder	
Pre-heat	180~200℃
Pre-heat time	120 sec. Max.
Peak-Temperature	260℃ Max.
Soldering time Condition	10 sec. Max.

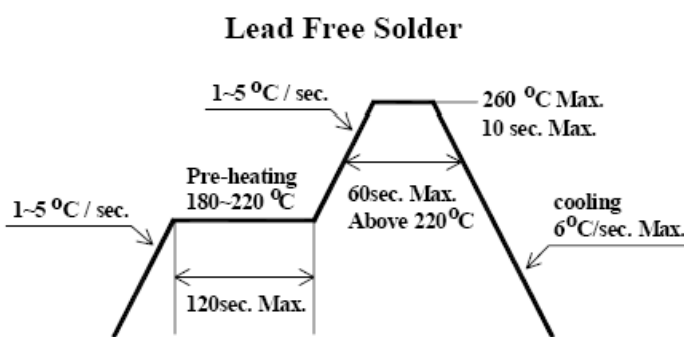

(2) Hand Soldering conditions

Do not exceed 4 seconds at maximum 315°C under soldering iron.

(3) The encapsulated material of the LEDs is silicone.

Precautions should be taken to avoid the strong pressure on the encapsulated part.

So when using the chip mounter, the picking up nozzle that does not affect the silicone resin should be used.

Note : In case that the soldered products are reused in soldering process, we don't guarantee the products.

11. Precaution for use

(1) Storage

In order to avoid the absorption of moisture, it is recommended to store in a dry box (or a desiccator) with a desiccant. Otherwise, to store them in the following environment is recommended.

Temperature : 5°C ~30°C Humidity : maximum 70%RH

(2) Attention after open.

LED is correspond to SMD, when LED be soldered dip, interfacial separation may affect the light transmission efficiency, causing the light intensity to drop.

Attention in followed;

Keeping of a fraction

Temperature : 5 ~ 40°C Humidity : less than 10%

(3) In the case of more than 1 week passed after opening or change color of indicator on desiccant, components shall be dried 10-12hr. at 60±5°C.

(4) Any mechanical force or any excess vibration shall not be accepted to apply during cooling process to normal temperature after soldering.

(5) Quick cooling shall be avoided.

(6) Components shall not be mounted on warped direction of PCB.

(7) Anti radioactive ray design is not considered for the products.

(8) This device should not be used in any type of fluid such as water, oil, organic solvent etc. When washing is required, IPA should be used.

(9) When the LEDs are illuminating, operating current should be decided after considering the ambient maximum temperature.

(10) The LEDs must be soldered within seven days after opening the moisture-proof packing.

(11) Repack unused products with anti-moisture packing, fold to close any opening and then store in a dry place.

(12) The appearance and specifications of the product may be modified for improvement without notice.

12. Reliability Test Item and Condition

Item	Reference	Test Condition	Duration / Cycle	Number of Damage
Thermal Shock	EIAJ ED-4701	$T_a = -40^{\circ}\text{C}$ (30MIN) \sim 100°C (30MIN)	100 Cycle	0/22
Temperature Cycle	EIAJ ED-4701	$T_a = -40^{\circ}\text{C}$ (30MIN) \sim 25°C (5MIN) \sim 100°C (30MIN) \sim 25°C (5MIN)	100 Cycle	0/22
High Temperature Storage	EIAJ ED-4701	$T_a = 100^{\circ}\text{C}$	1000 Hours	0/22
High Temperature High Humidity Storage	EIAJ ED-4701	$T_a = 85^{\circ}\text{C}$, RH=85%	1000 Hours	0/22
Low Temperature Storage	EIAJ ED-4701	$T_a = -40^{\circ}\text{C}$	1000 Hours	0/22
Operating Endurance Test	Internal Reference	$T_a = 25^{\circ}\text{C}$, $I_F = 20\text{mA}$	1000 Hours	0/22
High Temperature High Humidity Life Test	Internal Reference	$T_a = 85^{\circ}\text{C}$, RH=85%, $I_F = 15\text{mA}$	300 Hours	0/22
High Temperature Life Test	Internal Reference	$T_a = 85^{\circ}\text{C}$, $I_F = 20\text{mA}$	500 Hours	0/22
Low Temperature Life Test	Internal Reference	$T_a = -40^{\circ}\text{C}$, $I_F = 20\text{mA}$	1000 Hours	0/22
ESD(HBM)	MIL-STD-883D	1KV at 1.5k Ω ; 100pF	3 Time	0/22

□ Criteria for Judging the Damage

Item	Symbol	Condition	Criteria for Judgement	
			MIN	MAX
Forward Voltage	V_F	$I_F = 20\text{mA}$	-	USL*1 \times 1.2
Reverse Current	I_R	$V_R = 5\text{V}$	-	USL*1 \times 2.0
Luminous Intensity	I_V	$I_F = 20\text{mA}$	LSL*2 \times 0.5	-

Note : *1 USL : Upper Standard Level

*2 LSL : Lower Standard Level

X-ON Electronics

Largest Supplier of Electrical and Electronic Components

Click to view similar products for [Standard LEDs - SMD category](#):

Click to view products by [Seoul Semiconductor manufacturer](#):

Other Similar products are found below :

[LTST-C190KYKT](#) [LTST-C19GD2WT](#) [LTST-N683GBEW](#) [LTW-170ZDC](#) [LTW-M140SZS40](#) [598-8110-100F](#) [598-8170-100F](#) [598-8610-202F](#) [67-22VRVGC/TR8](#) [AAAF5060QBFSEEZGS](#) [HLMA-QG00-S0021](#) [HLMP-6305-L0011](#) [ALMD-LB36-SV002](#) [APT1608QGWW](#) [15-21UYC/S530-A3/TR8](#) [EAST2012YA0](#) [EASV1803BA0](#) [LG M67K-H1J2-24-0-2-R18-Z](#) [LS A676-P2S1-1](#) [SML310BATT86](#) [SML-512VWT86A](#) [SML-LX0606SISUGC/A](#) [SML-LXL1307SRC-TR](#) [SML-LXR851SIUPGUBC](#) [LT1ED53A](#) [FAT801-S](#) [AM27ZGC03](#) [APB3025SGNC](#) [APFA3010SURKCGKQBDC](#) [APHK1608VGCA](#) [APT2012QGW](#) [CLX6D-FKB-CN1R1H1BB7D3D3](#) [LTST-C250KGKT](#) [LTW-020ZDCG](#) [LTW-21TS5](#) [LTW-220DS5](#) [JANTXM19500/521-02](#) [UYGT801-S](#) [42-21UYC/S530-A3/TR8](#) [LO T67F-V1AB-24-1](#) [YGFR411-H](#) [598-8330-117F](#) [SML-LX0402IC-TR](#) [CMDA20AYAA7D1S](#) [CMDA16AYDR7A1X](#) [598-8040-100F](#) [598-8070-100F](#) [598-8140-100F](#) [598-8610-200F](#) [EAST2012GA0](#)