

# Specification

## SSC-STW8C2SA

SSC-STW8C2SA

Jan 2013

[www.seoulsemicon.com](http://www.seoulsemicon.com)

SSC-QP-7-07-12 (Rev.01)

# STW8C2SA

## Description

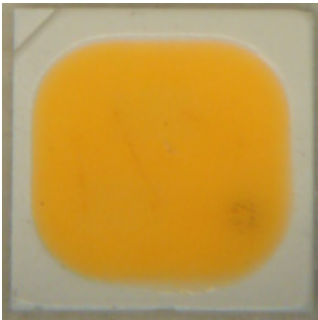

This surface-mount LED comes in standard package dimension. It has a substrate made up of a molded plastic reflector sitting on top of a lead frame. The die is attached within the reflector cavity and the cavity is encapsulated by silicone.

The package design coupled with careful selection of component materials allow these products to perform with high reliability.

# STW8C2SA

## Features

- Lead Frame type LED PKG  
size: 3.0\*3.0  
thickness 0.65mm
- White colored SMT package
- Pb-free Reflow Soldering Application
- RoHS compliant

## Applications

- Interior lighting
- General lighting
- Indoor and out door displays
- Architectural / Decorative lighting

## [ Contents ]

- 1. Full code of STW8C2SA**
- 2. Outline dimensions of STW8C2SA**
- 3. Characteristics of STW8C2SA**
- 4. Characteristic diagrams**
- 5. Color & Binning**
- 6. Bin Code Description**
- 7. Labeling**
- 8. Packing**
- 9. Recommended solder pad**
- 10. Soldering**
- 11. Precaution for use**
- 12. Handling of Silicone Resin LEDs**

## 1. Full code of STW8C2SA

**Full code form :  $X_1 X_2 - X_3 X_4 - X_5 - X_6 X_7 - X_8$**

### 1. Part Number

- $X_1$  : Company
- $X_2$  : Kind of LED

### 2. Internal Number

- $X_3 X_4$  : CRI Group
- $X_5$  : Package series
- $X_6 X_7$  : Characteristic code
- $X_8$  : Version

## 2. Outline dimensions of STW8C2SA

**Top View**

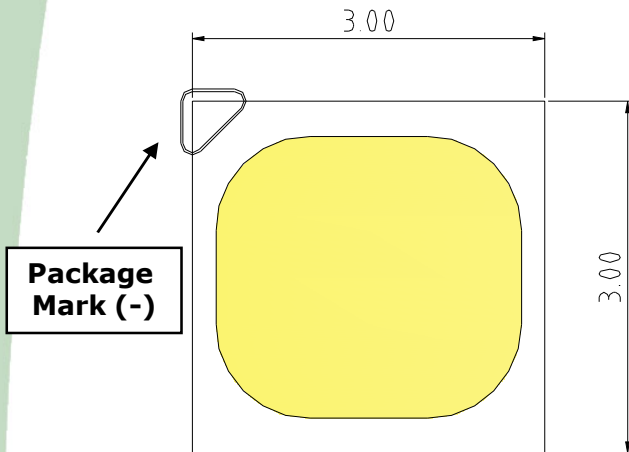

**Bottom View**

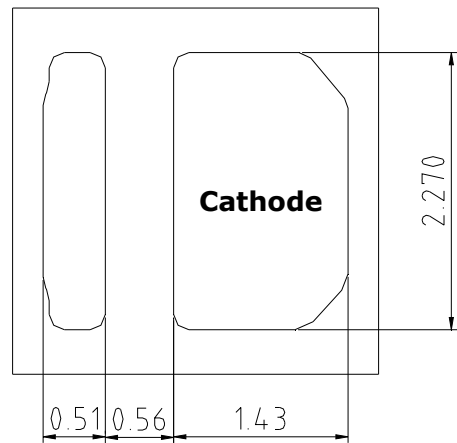

**Side View**



**Circuit**

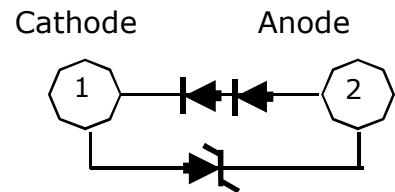

**ESD Protection Device**

Notes :

- [1] All dimensions are in millimeters.
- [2] Scale : none
- [3] Undefined tolerance is  $\pm 0.2\text{mm}$

**Material Structure**

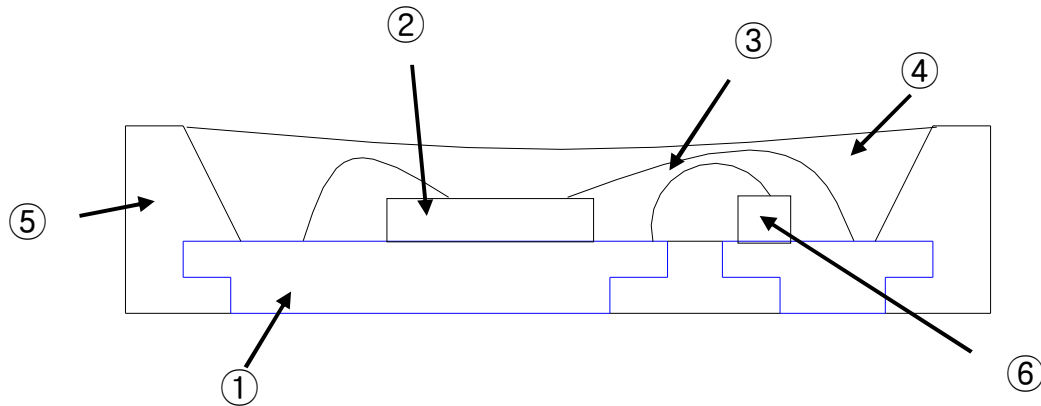

Parts No.	Name	Description	Materials
①	LEAD FRAME	Metal	Copper Alloy (Silver Plated)
②	Chip Source	Blue LED	GaN on Sapphire
③	Wire	Metal	Gold Wire
④	Encapsulation	Silicone	+Phosphor
⑤	Body	Thermo Plastic	Heat-resistant Polymer
⑥	Zener Diode	Si	-

### 3. Characteristics of STW8C2SA

#### 1) Electro-Optical characteristics at 100mA

(Ta=25°C, RH30%)

Parameter	Symbol	Value			Unit
		Min	Typ	Max	
<b>Forward Voltage</b>	V <sub>F</sub>	-	6.3	6.8	V
<b>Reverse Voltage</b>	V <sub>R</sub> (IR=5mA)	-	0.9	1.4	V
<b>Luminous Intensity*<sup>[1]</sup> (3,700~7,000 K)</b>	I <sub>v</sub>	-	22.4 (72.6)	-	cd (lm)
<b>Luminous Intensity*<sup>[1]</sup> (2,600~3,700 K)</b>	I <sub>v</sub>	-	20.9 (66.1)	-	cd (lm)
<b>Correlated Color Temperature</b>	CCT	2,600	-	7,000	K
<b>Viewing Angle <sup>[2]</sup></b>	2θ <sub>1/2</sub>	-	120	-	-
<b>Thermal resistance <sup>[3]</sup></b>	R <sub>thJS</sub>	-	10	-	°C/W
<b>Color Rendering Index*</b>	Ra	80	83	90	-

\*Notes :

All measurements were made under the standardized environment of SSC.

[1] The luminous intensity I<sub>v</sub> was measured at the peak of the spatial pattern which may not be aligned with the mechanical axis of the LED package.

[2] 2θ<sub>1/2</sub> is the off-axis where the luminous intensity is 1/2 of the peak intensity.

[3] Thermal resistance: R<sub>th JS</sub> (Junction / solder)

\* Tolerance : V<sub>F</sub> : ±0.2V, I<sub>v</sub> : ±7%, R<sub>a</sub> : ±2, x,y : ±0.007

#### 2) Absolute Maximum Ratings

Parameter	Symbol	Value	Unit
<b>Forward Current</b>	I <sub>F</sub>	200	mA
<b>Power Dissipation*<sup>[1]</sup></b>	P <sub>d</sub>	1.36	W
<b>Junction Temperature</b>	T <sub>j</sub>	125	°C
<b>Operating Temperature</b>	T <sub>opr</sub>	-40 ~ +85	°C
<b>Storage Temperature</b>	T <sub>stg</sub>	-40 ~ +100	°C
<b>ESD (HBM)</b>		±5,000V HBM	V

\*Notes :

LED's properties might be different from suggested values like above and below tables if operation condition will be exceeded our parameter range.

[1] Care is to be taken that power dissipation does not exceed the absolute maximum rating of the product.

SSC-STW8C2SA

Jan 2013

www.seoulsemicon.com

SSC-QP-7-07-12 (Rev.01)

## 4. Characteristic diagrams

### 1) Spectrum data

(IF=100mA, Ta=25°C, RH30%)

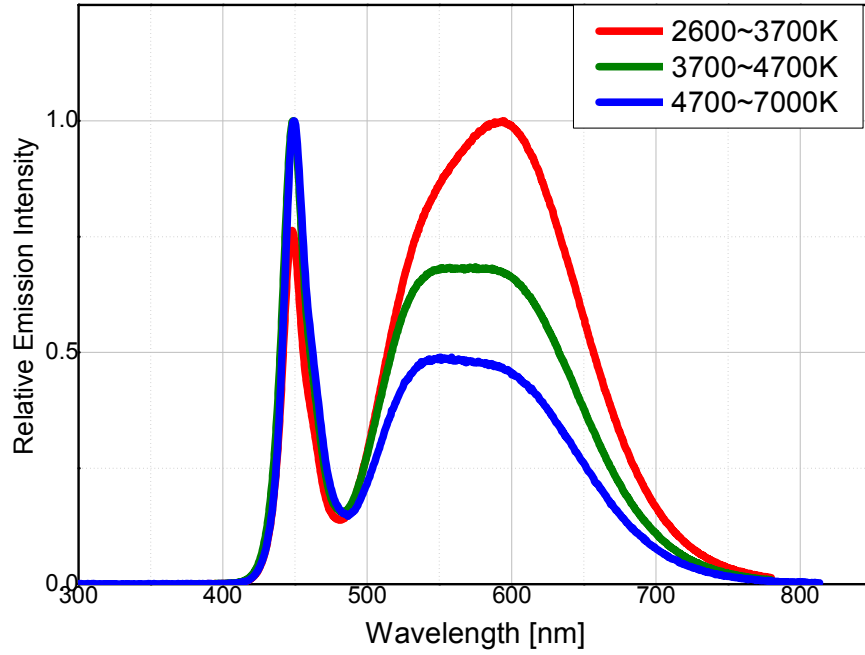

### 2) Viewing angle, Ta=25°C

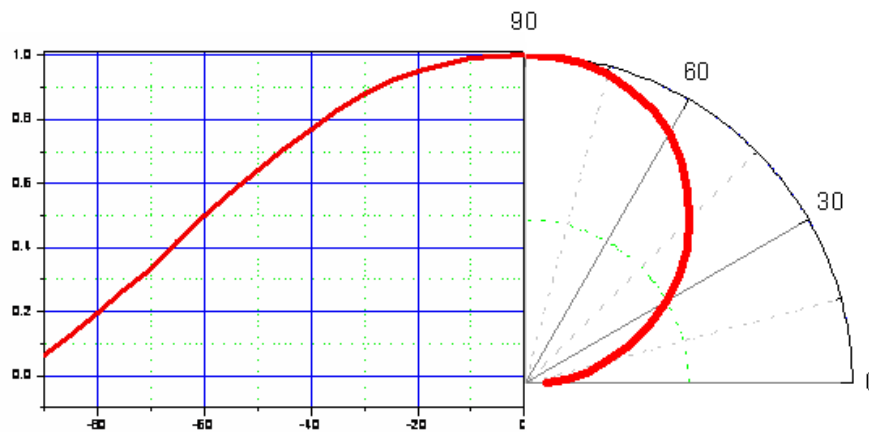



**3) Forward Voltage vs. Forward Current, Ta=25°C**

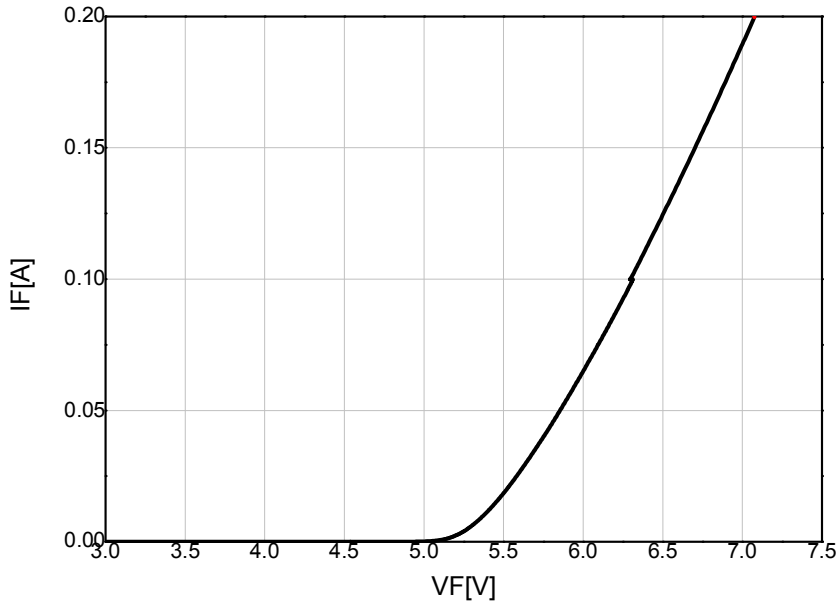

**4) Forward Current vs. Relative Luminous Intensity, Ta=25°C**

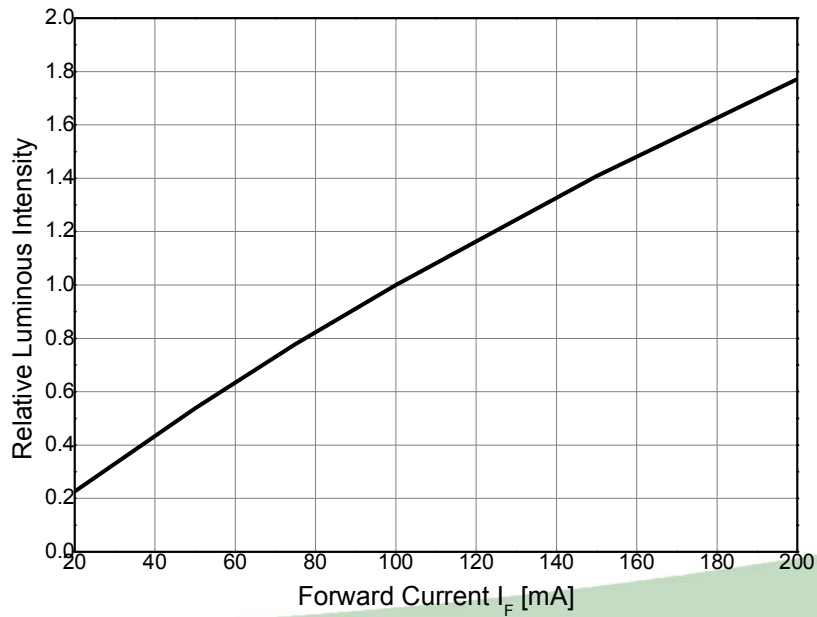

**5) Chromaticity Coordinate vs. Forward Current, Ta=25°C**

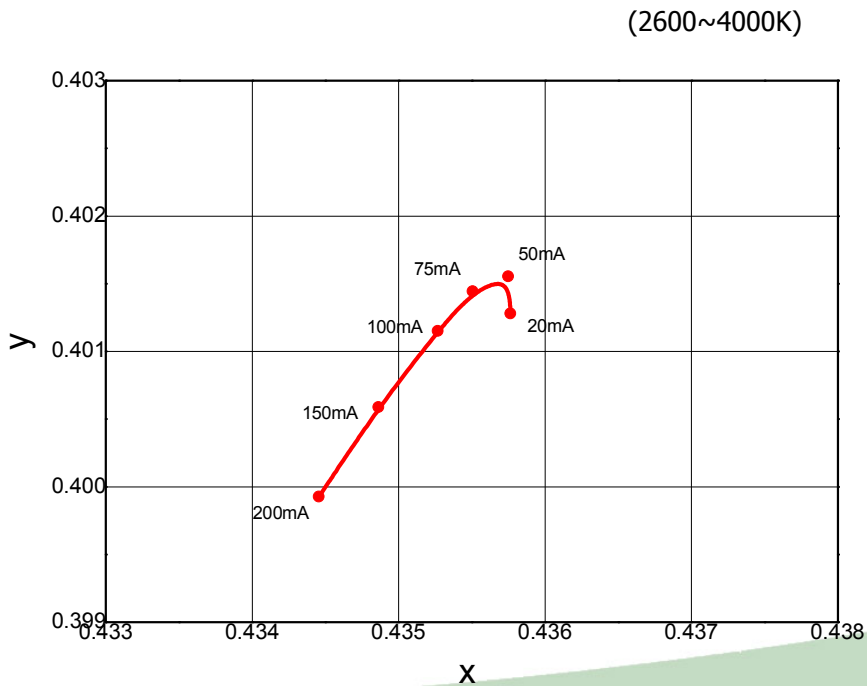
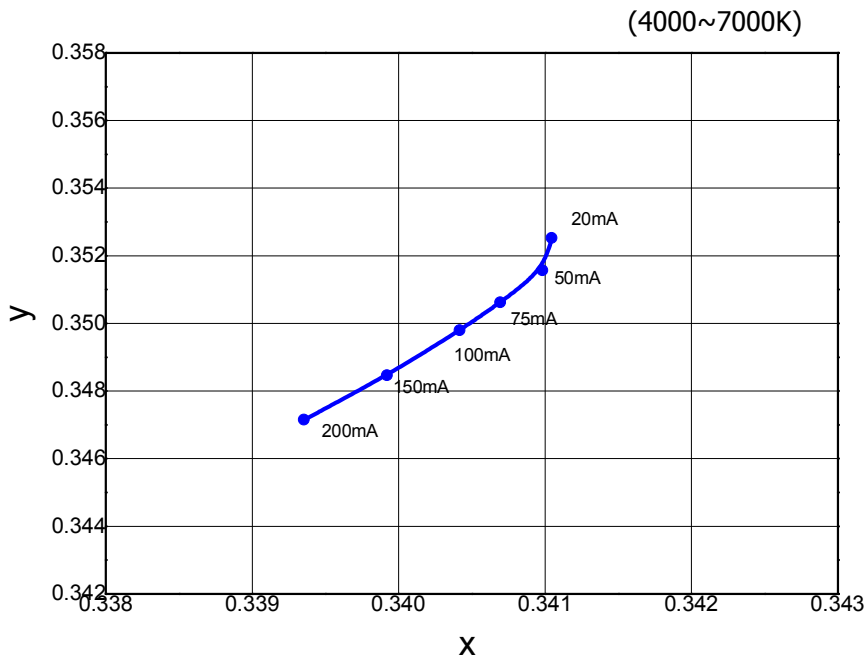

**6) Relative Luminous Intensity vs. Junction Temperature, IF=100mA**

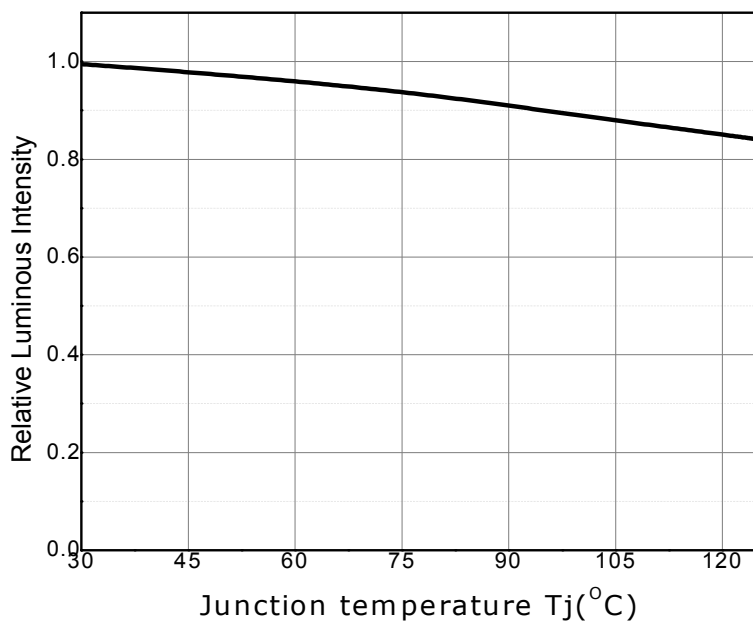

**7) Chromaticity Coordinate vs. Junction Temperature**

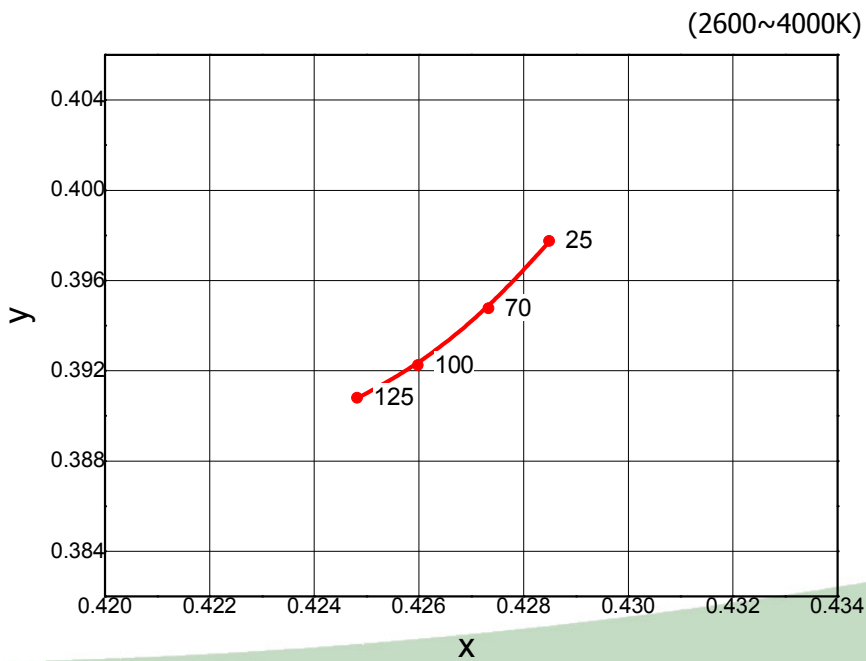
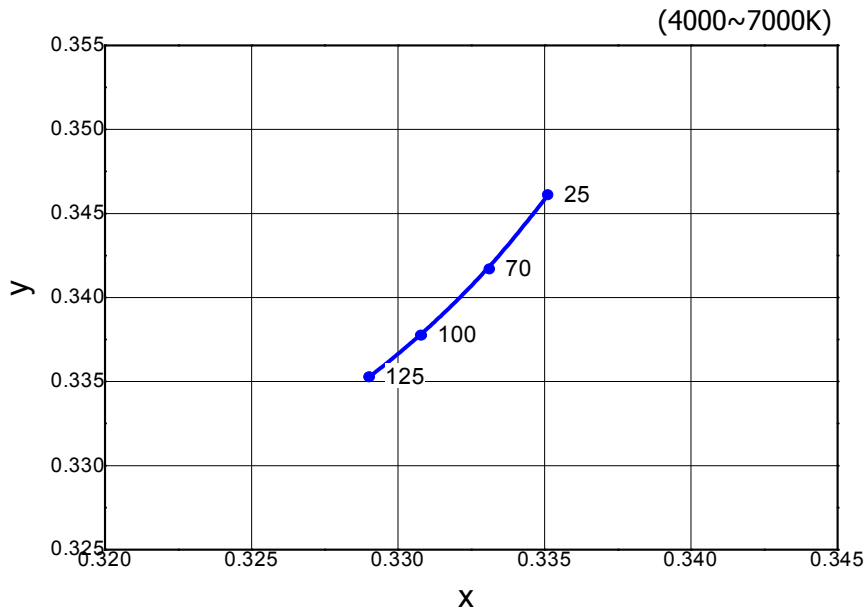

**8) Junction Temperature vs. Relative Forward Voltage**

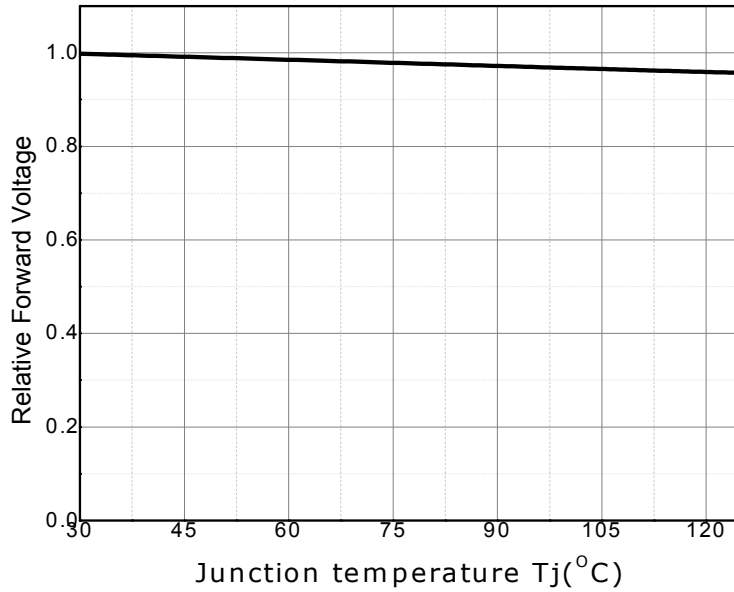

**9) Ambient Temperature vs. Maximum Forward Current**

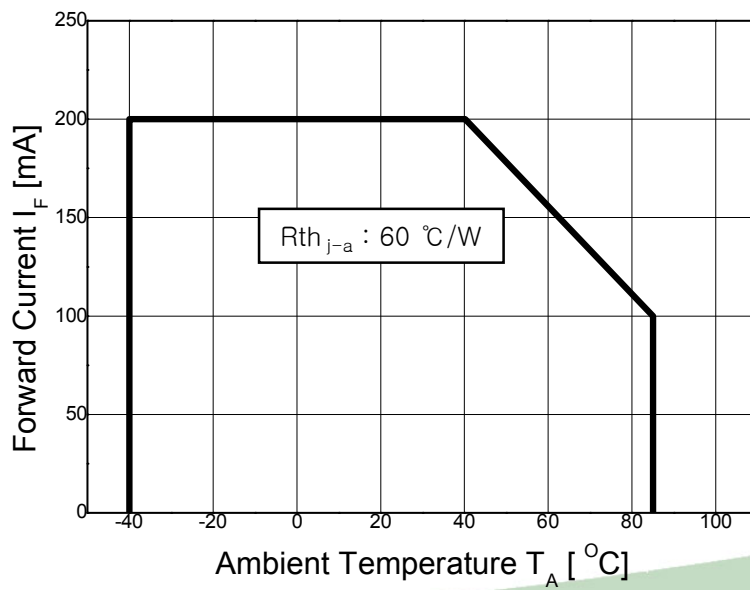

## 5. Color & Binning

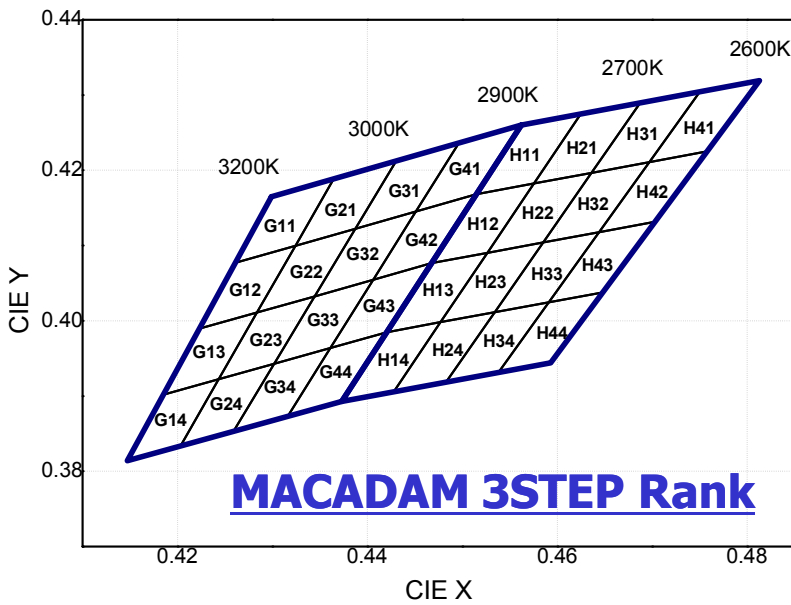
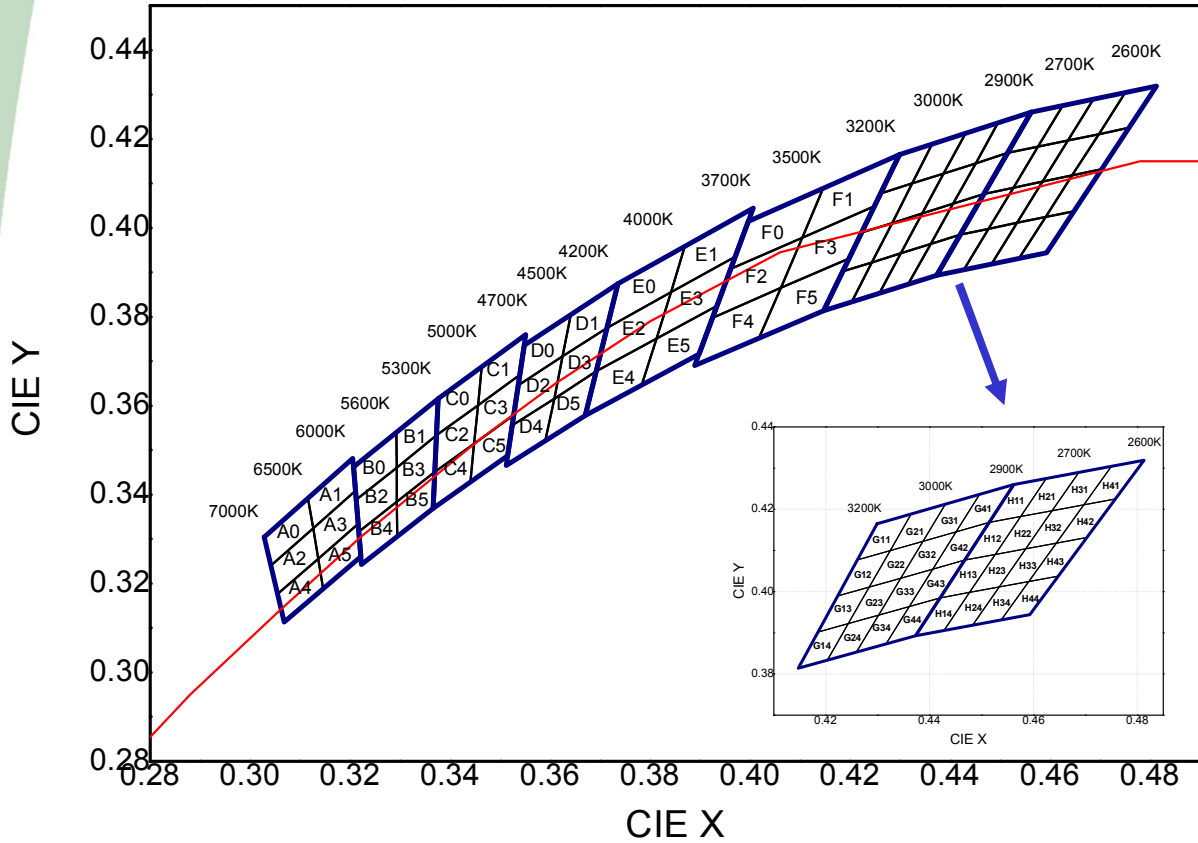

\* Apply the Energy Star binning(3200~7000K) & MACADAM 3 Step binning (just, 2600~3200K)

\* Measurement Uncertainty of the Color Coordinates :  $\pm 0.007$

SSC-STW8C2SA

Jan 2013

[www.seoulsemicon.com](http://www.seoulsemicon.com)

SSC-QP-7-07-12 (Rev.01)

## 5. Color & Binning

● COLOR RANK

<IF=100mA, Ta=25℃>

A0		A1		A2	
CIE X	CIE Y	CIE X	CIE Y	CIE X	CIE Y
0.3028	0.3304	0.3115	0.3393	0.3041	0.324
0.3041	0.324	0.3126	0.3324	0.3055	0.3177
0.3126	0.3324	0.321	0.3408	0.3136	0.3256
0.3115	0.3393	0.3205	0.3481	0.3126	0.3324
A3		A4		A5	
CIE X	CIE Y	CIE X	CIE Y	CIE X	CIE Y
0.3126	0.3324	0.3055	0.3177	0.3136	0.3256
0.3136	0.3256	0.3068	0.3113	0.3146	0.3187
0.3216	0.3334	0.3146	0.3187	0.3221	0.3261
0.321	0.3408	0.3136	0.3256	0.3216	0.3334
B0		B1		B2	
CIE X	CIE Y	CIE X	CIE Y	CIE X	CIE Y
0.3207	0.3462	0.3292	0.3539	0.3212	0.3389
0.3212	0.3389	0.3293	0.3461	0.3217	0.3316
0.3293	0.3461	0.3373	0.3534	0.3293	0.3384
0.3292	0.3539	0.3376	0.3616	0.3293	0.3461
B3		B4		B5	
CIE X	CIE Y	CIE X	CIE Y	CIE X	CIE Y
0.3293	0.3461	0.3217	0.3316	0.3293	0.3384
0.3293	0.3384	0.3222	0.3243	0.3294	0.3306
0.3369	0.3451	0.3294	0.3306	0.3366	0.3369
0.3373	0.3534	0.3293	0.3384	0.3369	0.3451

\* Measurement Uncertainty of the Color Coordinates : ± 0.007

## 5. Color & Binning

● COLOR RANK

<IF=100mA, Ta=25℃>

C0		C1		C2	
CIE X	CIE Y	CIE X	CIE Y	CIE X	CIE Y
0.3376	0.3616	0.3463	0.3687	0.3373	0.3534
0.3373	0.3534	0.3456	0.3601	0.3369	0.3451
0.3456	0.3601	0.3539	0.3669	0.3448	0.3514
0.3463	0.3687	0.3552	0.376	0.3456	0.3601
C3		C4		C5	
CIE X	CIE Y	CIE X	CIE Y	CIE X	CIE Y
0.3456	0.3601	0.3369	0.3451	0.3448	0.3514
0.3448	0.3514	0.3366	0.3369	0.344	0.3428
0.3526	0.3578	0.344	0.3428	0.3514	0.3487
0.3539	0.3669	0.3448	0.3514	0.3526	0.3578
D0		D1		D2	
CIE X	CIE Y	CIE X	CIE Y	CIE X	CIE Y
0.3548	0.3736	0.3641	0.3804	0.3536	0.3646
0.3536	0.3646	0.3625	0.3711	0.3523	0.3555
0.3625	0.3711	0.3714	0.3775	0.3608	0.3616
0.3641	0.3804	0.3736	0.3874	0.3625	0.3711
D3		D4		D5	
CIE X	CIE Y	CIE X	CIE Y	CIE X	CIE Y
0.3625	0.3711	0.3523	0.3555	0.3608	0.3616
0.3608	0.3616	0.3511	0.3465	0.359	0.3521
0.3692	0.3677	0.359	0.3521	0.367	0.3578
0.3714	0.3775	0.3608	0.3616	0.3692	0.3677

\* Measurement Uncertainty of the Color Coordinates : ± 0.007



## 5. Color & Binning

● COLOR RANK

<IF=100mA, Ta=25℃>

E0		E1		E2	
CIE X	CIE Y	CIE X	CIE Y	CIE X	CIE Y
0.3736	0.3874	0.3869	0.3958	0.3714	0.3775
0.3714	0.3775	0.3842	0.3855	0.3692	0.3677
0.3842	0.3855	0.397	0.3935	0.3813	0.3751
0.3869	0.3958	0.4006	0.4044	0.3842	0.3855
E3		E4		E5	
CIE X	CIE Y	CIE X	CIE Y	CIE X	CIE Y
0.3842	0.3855	0.3692	0.3677	0.3813	0.3751
0.3813	0.3751	0.367	0.3578	0.3783	0.3646
0.3934	0.3825	0.3783	0.3646	0.3898	0.3716
0.397	0.3935	0.3813	0.3751	0.3934	0.3825
F0		F1		F2	
CIE X	CIE Y	CIE X	CIE Y	CIE X	CIE Y
0.3996	0.4015	0.4146	0.4089	0.396	0.3907
0.396	0.3907	0.4104	0.3978	0.3925	0.3798
0.4104	0.3978	0.4248	0.4048	0.4062	0.3865
0.4146	0.4089	0.4299	0.4165	0.4104	0.3978
F3		F4		F5	
CIE X	CIE Y	CIE X	CIE Y	CIE X	CIE Y
0.4104	0.3978	0.3925	0.3798	0.4062	0.3865
0.4062	0.3865	0.3889	0.369	0.4017	0.3751
0.4198	0.3931	0.4017	0.3751	0.4147	0.3814
0.4248	0.4048	0.4062	0.3865	0.4198	0.3931

\* Measurement Uncertainty of the Color Coordinates : ± 0.007

## 5. Color & Binning

● COLOR RANK

<IF=100mA, Ta=25℃>

G11		G21		G31		G41	
CIE X	CIE Y	CIE X	CIE Y	CIE X	CIE Y	CIE X	CIE Y
0.4365	0.4189	0.4430	0.4212	0.4496	0.4236	0.4562	0.4260
0.4324	0.4100	0.4387	0.4122	0.4451	0.4145	0.4515	0.4168
0.4261	0.4077	0.4324	0.4100	0.4387	0.4122	0.4451	0.4145
0.4299	0.4165	0.4365	0.4189	0.4430	0.4212	0.4496	0.4236
G12		G22		G32		G42	
CIE X	CIE Y	CIE X	CIE Y	CIE X	CIE Y	CIE X	CIE Y
0.4324	0.4100	0.4387	0.4122	0.4451	0.4145	0.4515	0.4168
0.4284	0.4011	0.4345	0.4033	0.4406	0.4055	0.4468	0.4077
0.4223	0.3990	0.4284	0.4011	0.4345	0.4033	0.4406	0.4055
0.4261	0.4077	0.4324	0.4100	0.4387	0.4122	0.4451	0.4145
G13		G23		G33		G43	
CIE X	CIE Y	CIE X	CIE Y	CIE X	CIE Y	CIE X	CIE Y
0.4284	0.4011	0.4345	0.4033	0.4406	0.4055	0.4468	0.4077
0.4243	0.3922	0.4302	0.3943	0.4361	0.3964	0.4420	0.3985
0.4185	0.3902	0.4243	0.3922	0.4302	0.3943	0.4361	0.3964
0.4223	0.3990	0.4284	0.4011	0.4345	0.4033	0.4406	0.4055
G14		G24		G34		G44	
CIE X	CIE Y	CIE X	CIE Y	CIE X	CIE Y	CIE X	CIE Y
0.4243	0.3922	0.4302	0.3943	0.4361	0.3964	0.4316	0.3873
0.4203	0.3834	0.4259	0.3853	0.4259	0.3853	0.4302	0.3943
0.4147	0.3814	0.4203	0.3834	0.4420	0.3985	0.4373	0.3893
0.4185	0.3902	0.4243	0.3922	0.4316	0.3873	0.4361	0.3964

SSC-STW8C2SA

Jan 2013

[www.seoulsemicon.com](http://www.seoulsemicon.com)

\* Measurement Uncertainty of the Color Coordinates : ± 0.007

SSC-QP-7-07-12 (Rev.01)

## 5. Color & Binning

● COLOR RANK

<IF=100mA, Ta=25°C>

H11		H21		H31		H41	
CIE X	CIE Y	CIE X	CIE Y	CIE X	CIE Y	CIE X	CIE Y
0.4325	0.4275	0.4687	0.4289	0.4750	0.4304	0.4810	0.4319
0.4575	0.4182	0.4636	0.4197	0.4697	0.4211	0.4758	0.4225
0.4515	0.4168	0.4575	0.4182	0.4636	0.4197	0.4697	0.4211
0.4562	0.4260	0.4625	0.4275	0.4687	0.4289	0.4750	0.4304
H12		H22		H32		H42	
CIE X	CIE Y	CIE X	CIE Y	CIE X	CIE Y	CIE X	CIE Y
0.4575	0.4182	0.4636	0.4197	0.4697	0.4211	0.4758	0.4225
0.4526	0.4090	0.4585	0.4104	0.4644	0.4118	0.4703	0.4132
0.4468	0.4077	0.4526	0.4090	0.4585	0.4104	0.4644	0.4118
0.4515	0.4168	0.4575	0.4182	0.4636	0.4197	0.4697	0.4211
H13		H23		H33		H43	
CIE X	CIE Y	CIE X	CIE Y	CIE X	CIE Y	CIE X	CIE Y
0.4526	0.4090	0.4585	0.4104	0.4644	0.4118	0.4703	0.4132
0.4477	0.3998	0.4534	0.4012	0.4591	0.4025	0.4648	0.4038
0.4420	0.3985	0.4477	0.3998	0.4534	0.4012	0.4591	0.4025
0.4468	0.4077	0.4526	0.4090	0.4585	0.4104	0.4644	0.4118
H14		H24		H34		H44	
CIE X	CIE Y	CIE X	CIE Y	CIE X	CIE Y	CIE X	CIE Y
0.4477	0.3998	0.4534	0.4012	0.4591	0.4025	0.4648	0.4038
0.4428	0.3906	0.4483	0.3919	0.4538	0.3932	0.4593	0.3944
0.4373	0.3893	0.4428	0.3906	0.4483	0.3919	0.4538	0.3932
0.4420	0.3985	0.4477	0.3998	0.4534	0.4012	0.4591	0.4025

SSC-STW8C2SA

Jan 2013

www.seoulsemicon.com

\* Measurement Uncertainty of the Color Coordinates : ± 0.007

SSC-QP-7-07-12 (Rev.01)

## 6. Bin Code Description

Bin Code		
Luminous Intensity [cd]	Color Rank	Forward Voltage [V]
K21	C3	Z62

Luminous Intensity [cd] \*<sup>[1]</sup>  
@  $I_f = 100\text{mA}$

RANK	Min.	Max.
J17	17	19.5
J19	19.5	21.5
K21	21.5	24
K24	24	27.5

Color Rank  
@  $I_f = 100\text{mA}$



A ~ H
-------

Forward Voltage [V]  
@  $I_f = 100\text{mA}$

RANK	Min.	Max.
Z58	5.8	6.0
Z60	6.0	6.2
Z62	6.2	6.4
Z64	6.4	6.6
Z66	6.6	6.8

CCT	CIE	IV Rank			
3200~7000K	A-F	J17	J19	K21	K24
2600~3200K	G-H	J17	J19	K21	K24

IV rank			Flux rank **		
RANK	Min.	Max.	RANK	Min.	Max.
J17	17	19.5	J17	52.7	60.5
J19	19.5	21.5	J19	60.5	66.7
K21	21.5	24	K21	66.7	74.4
K24	24	27.5	K24	74.4	85.3

 Available ranks  
 Not yet available ranks

**\*Notes :**

All measurements were made under the standardized environment of SSC.

In order to ensure availability, single color rank will not be orderable.

[1] SSC sort the LED package according to the luminous intensity IV.

\*\* The lumen table is only for reference.

SSC-STW8C2SA

Jan 2013

www.seoulsemicon.com

## 7. Labeling

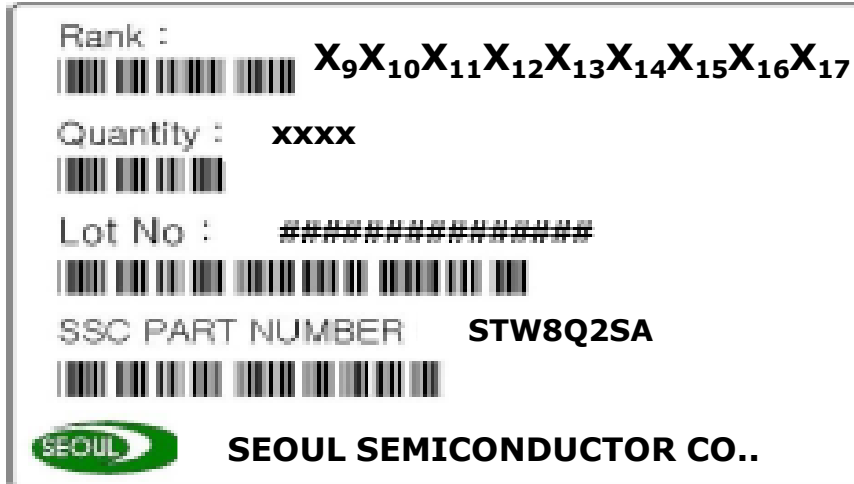

### Rank

X<sub>9</sub>X<sub>10</sub>X<sub>11</sub>X<sub>12</sub>X<sub>13</sub>X<sub>14</sub>X<sub>15</sub>X<sub>16</sub>X<sub>17</sub>

- **X<sub>9</sub>X<sub>10</sub>X<sub>11</sub> : Luminous Intensity : IV [cd]**
- **X<sub>12</sub>X<sub>13</sub>X<sub>14</sub> : Color coordinates : x, y  
(3200K~7000K : 2 Digits except X<sub>14</sub>)**
- **X<sub>15</sub>X<sub>16</sub>X<sub>17</sub> : Forward Voltage : V<sub>F</sub> [V]**

## 8. Packing

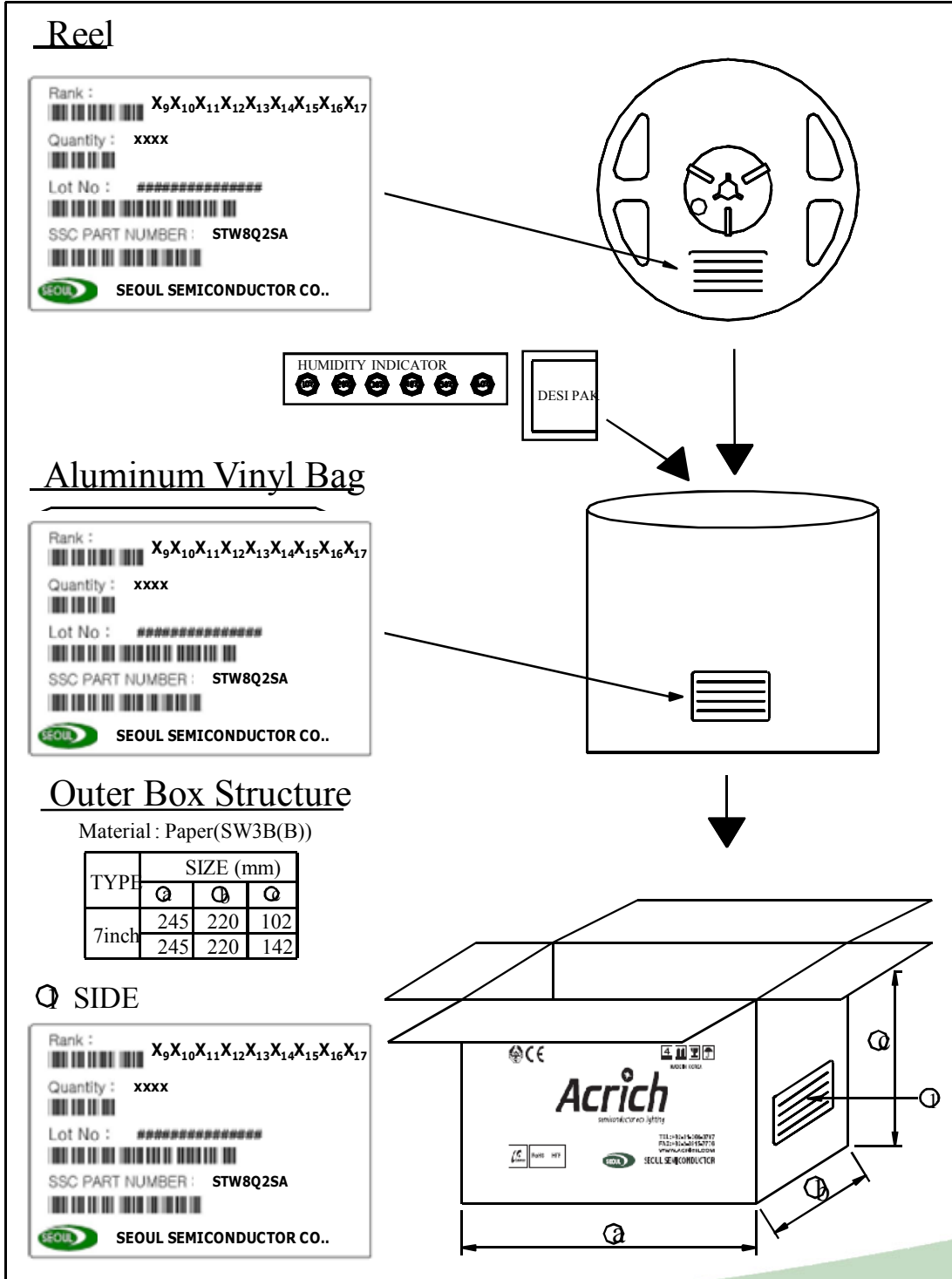

SSC-STW8C2SA

Jan 2013

www.seoulsemicon.com

SSC-QP-7-07-12 (Rev.01)

## 8. Packing

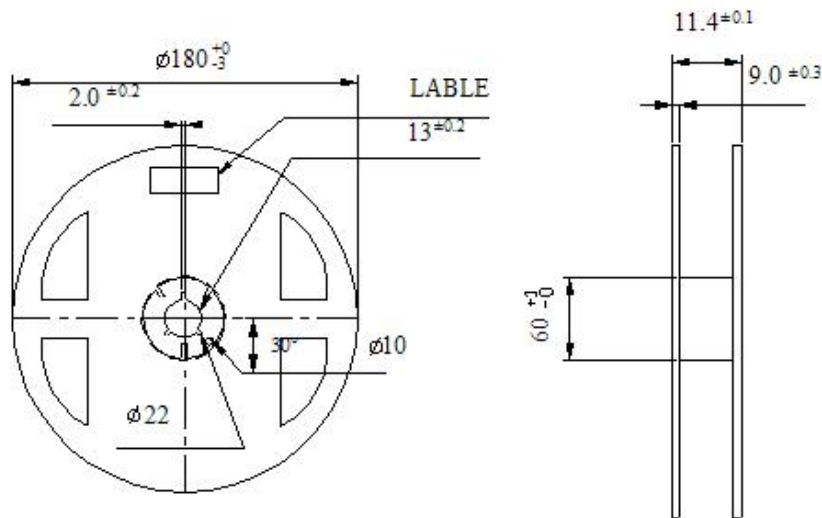
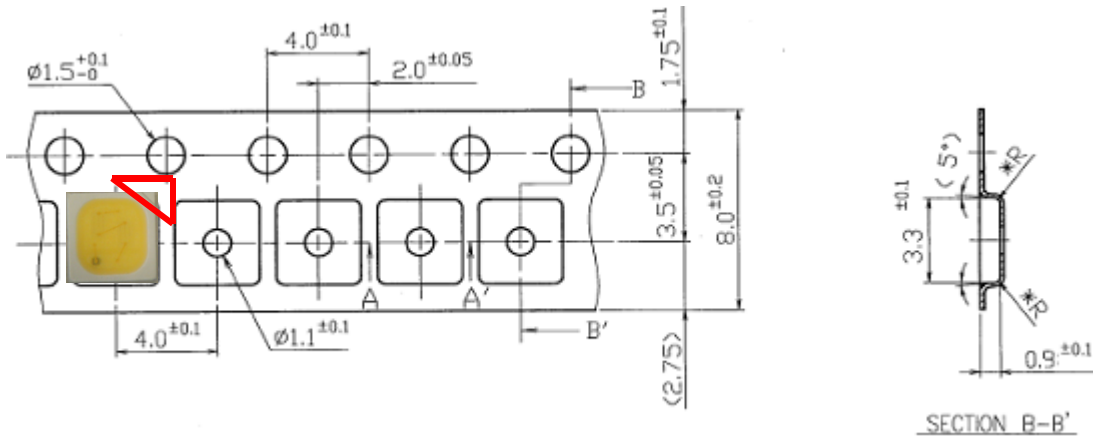

(Tolerance:  $\pm 0.2$ , Unit: mm)

- 1) Quantity : Max 4,500pcs/Reel (2000 ~ 4500pcs by 500pcs provided)
- 2) Cumulative Tolerance : Cumulative Tolerance/10 pitches to be  $\pm 0.2$ mm
- 3) Adhesion Strength of Cover Tape : Adhesion strength to be 0.1-0.7N when the cover tape is turned off from the carrier tape at the angle of  $10^\circ$  to the carrier tape.
- 4) Package : P/N, Manufacturing data Code No. and quantity to be indicated on a damp proof Package.

SSC-STW8C2SA

Jan 2013

www.seoulsemicon.com

SSC-QP-7-07-12 (Rev.01)

## 9. Recommended solder pad

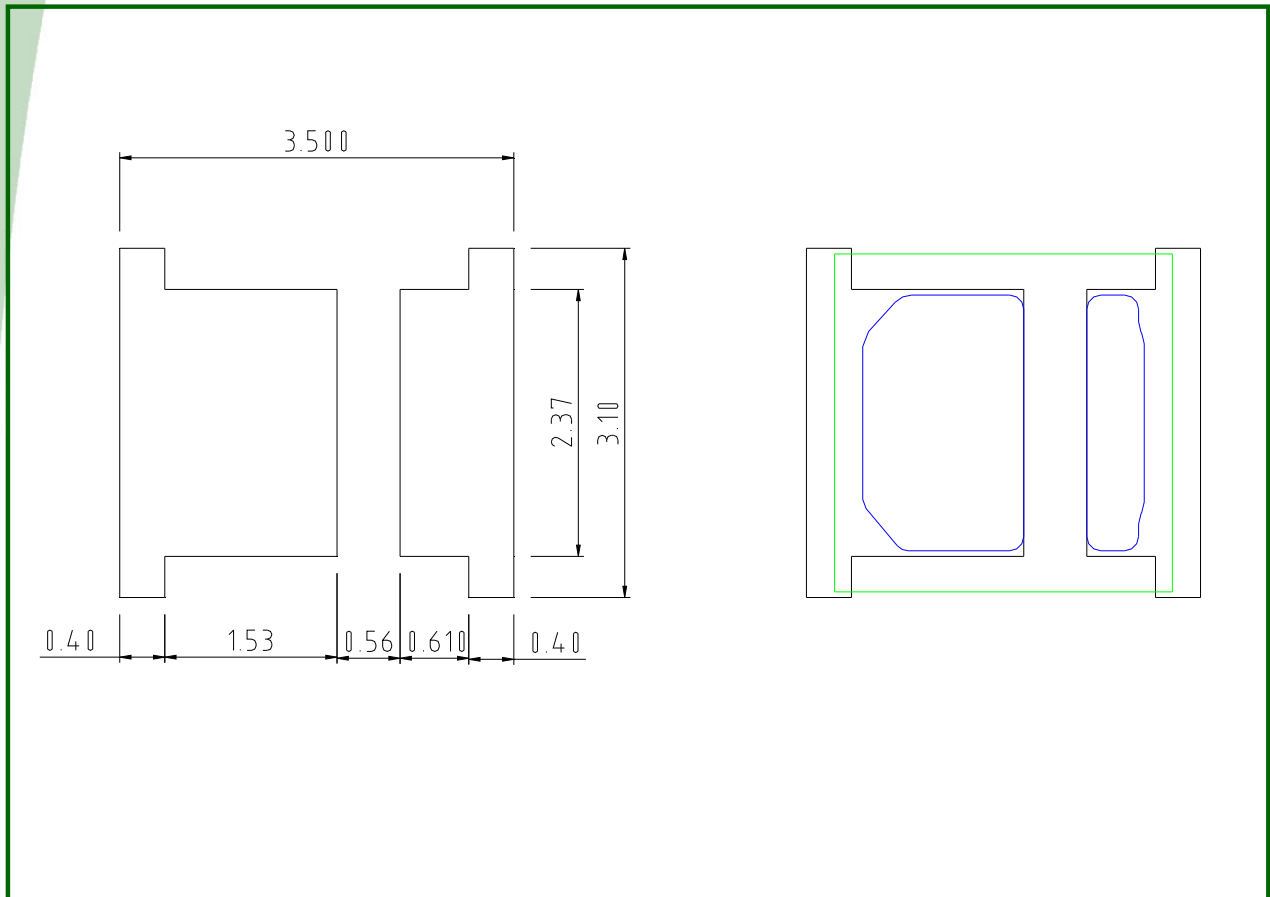

**Notes :**

- [1] All dimensions are in millimeters.
- [2] Scale : none
- [3] Recommended Solder Thickness : 0.15 mm
- [4] Undefined tolerance is  $\pm 0.2$ mm  
This drawing without tolerances are for reference only.



## 10. Soldering

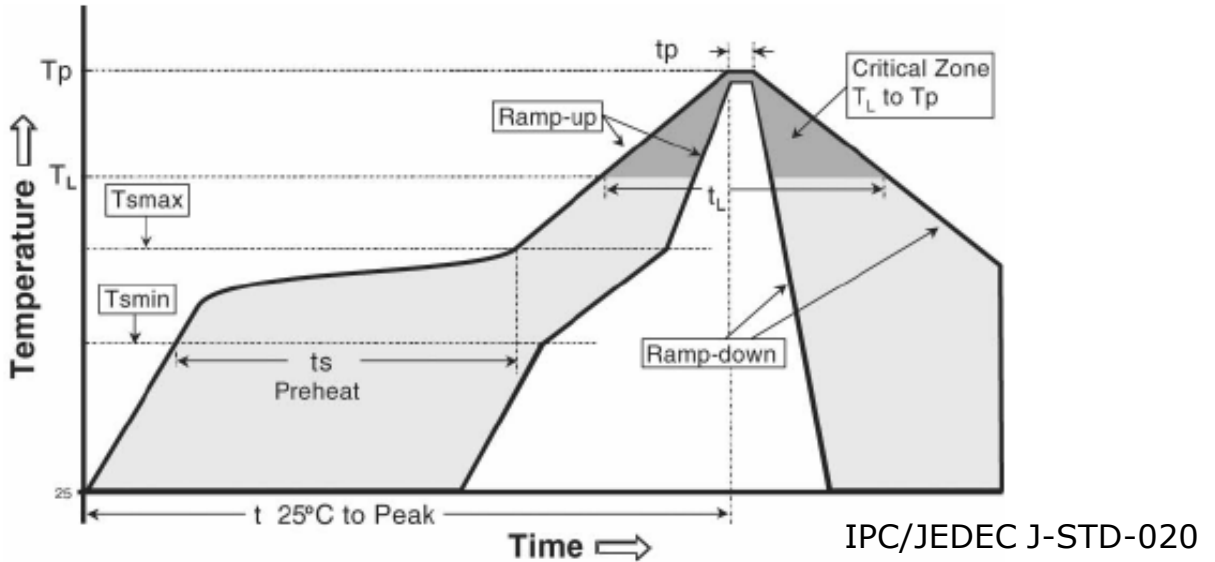

Profile Feature	Sn-Pb Eutectic Assembly	Pb-Free Assembly
<b>Average ramp-up rate (Tsmmax to Tp)</b>	3° C/second max.	3° C/second max.
<b>Preheat</b> - Temperature Min (Tsmmin) - Temperature Max (Tsmmax) - Time (Tsmmin to Tsmmax) (ts)	100 °C 150 °C 60-120 seconds	150 °C 200 °C 60-180 seconds
Time maintained above: - Temperature (Tl) - Time (tl)	183 °C 60-150 seconds	217 °C 60-150 seconds
Peak Temperature (Tp)	215 °C	260 °C
Time within 5°C of actual Peak Temperature (tp)2	10-30 seconds	20-40 seconds
Ramp-down Rate	6 °C/second max.	6 °C/second max.
Time 25°C to Peak Temperature	6 minutes max.	8 minutes max.

**\* Caution**

1. Reflow soldering is recommended not to be done more than two times. In the case of more than 24 hours passed soldering after first, LEDs will be damaged.
2. Repairs should not be done after the LEDs have been soldered. When repair is unavoidable, suitable tools must be used.
3. Die slug is to be soldered.
4. When soldering, do not put stress on the LEDs during heating.
5. After soldering, do not warp the circuit board.

SSC-STW8C2SA

Jan 2013

www.seoulsemicon.com

## 11. Precaution for use

### (1) Storage

To avoid the moisture penetration, we recommend store in a dry box with a desiccant . The recommended storage temperature range is 5°C to 30°C and a maximum humidity of RH50%.

### (2) Use Precaution after Opening the Packaging

Use proper SMD techniques when the LED is to be soldered dipped as separation of the lens may affect the light output efficiency.

Pay attention to the following:

#### a. Recommend conditions after opening the package

- Sealing

- Temperature : 5 ~ 40°C Humidity : less than RH30%

b. If the package has been opened more than 4 week(MSL\_2a) or the color of the desiccant changes, components should be dried for 10-12hr at 60±5°C

(3) Do not apply mechanical force or excess vibration during the cooling process to normal temperature after soldering.

(4) Do not rapidly cool device after soldering.

(5) Components should not be mounted on warped (non coplanar) portion of PCB.

(6) Radioactive exposure is not considered for the products listed here in.

(7) Gallium arsenide is used in some of the products listed in this publication. These products are dangerous if they are burned or shredded in the process of disposal. It is also dangerous to drink the liquid or inhale the gas generated by such products when chemically disposed of.

(8) This device should not be used in any type of fluid such as water, oil, organic solvent and etc. When washing is required, IPA (Isopropyl Alcohol) should be used.

(9) When the LEDs are in operation the maximum current should be decided after measuring the package temperature.

(10) LEDs must be stored properly to maintain the device. If the LEDs are stored for 3 months or more after being shipped from SSC, a sealed container with a nitrogen atmosphere should be used for storage.

(11) The appearance and specifications of the product may be modified for improvement without notice.

(12) Long time exposure of sunlight or occasional UV exposure will cause lens discoloration.

(13) VOCs (Volatile organic compounds) emitted from materials used in the construction of fixtures can penetrate silicone encapsulants of LEDs and discolor when exposed to heat and photonic energy. The result can be a significant loss of light output from the fixture.

Knowledge of the properties of the materials selected to be used in the construction of fixtures can help prevent these issues.

(14)Attaching LEDs, do not use adhesives that outgas organic vapor.

(15)The driving circuit must be designed to allow forward voltage only when it is ON or OFF.

If the reverse voltage is applied to LED, migration can be generated resulting in LED damage.

SSC-STW8C2SA

Jan 2013

www.seoulsemicon.com

## 12. Handling of Silicone Resin LEDs

(1) During processing, mechanical stress on the surface should be minimized as much as possible. Sharp objects of all types should not be used to pierce the sealing compound.

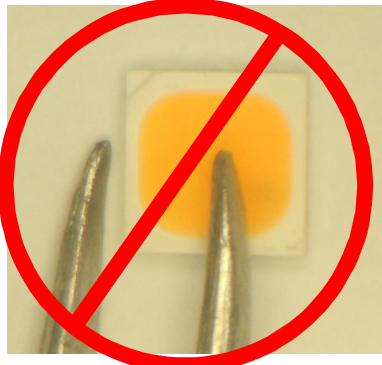

(2) In general, LEDs should only be handled from the side. By the way, this also applies to LEDs without a silicone sealant, since the surface can also become scratched.

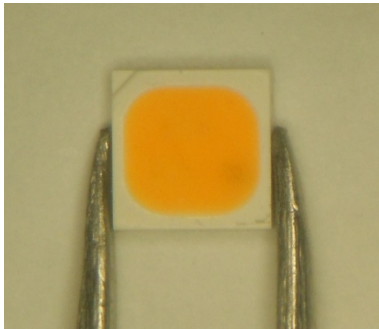

(3) When populating boards in SMT production, there are basically no restrictions regarding the form of the pick and place nozzle, except that mechanical pressure on the surface of the resin must be prevented. This is assured by choosing a pick and place nozzle which is larger than the LED's reflector area.

(4) Silicone differs from materials conventionally used for the manufacturing of LEDs. These conditions must be considered during the handling of such devices. Compared to standard encapsulants, silicone is generally softer, and the surface is more likely to attract dust.

As mentioned previously, the increased sensitivity to dust requires special care during processing. In cases where a minimal level of dirt and dust particles cannot be guaranteed, a suitable cleaning solution must be applied to the surface after the soldering of components.

(5) SSC suggests using isopropyl alcohol for cleaning. In case other solvents are used, it must be assured that these solvents do not dissolve the package or resin.

Ultrasonic cleaning is not recommended. Ultrasonic cleaning may cause damage to the LED.

(6) Please do not mold this product into another resin (epoxy, urethane, etc) and do not handle this product with acid or sulfur material in sealed space.

## X-ON Electronics

Largest Supplier of Electrical and Electronic Components

*Click to view similar products for [High Power LEDs - White category:](#)*

*Click to view products by [Seoul Semiconductor manufacturer:](#)*

Other Similar products are found below :

[LTW-K140SZR40](#) [B42180-08](#) [STW8Q2PA-R5-HA](#) [LTPL-P00DWS57](#) [LTW-K140SZR30](#) [LZP-D0WW00-0000](#) [SAW8WA2A-L35M40-CA](#)  
[SZ5-M1-WW-C8-V1/V3-FA](#) [LTW-K140SZR57](#) [LTW-K140SZR27](#) [BXRE-50C2001-C-74](#) [LTW-5630AQL57](#) [MP-5050-8100-27-80](#) [MP-](#)  
[5050-6100-65-80](#) [MP-5050-6100-50-80](#) [MP-5050-6100-40-80](#) [MP-5050-6100-30-80](#) [KW DPLS32.SB-6H6J-E5P7-EG-Z264](#) [L1V1-](#)  
[507003V500000](#) [KW CULPM1.TG-Z6RF7-ebvFfcbB46-65G5](#) [KW DMLS33.SG-Z6M7-EBVFFCBB46-8E8G-700-S](#) [GW PSLT33.PM-LYL3-](#)  
[XX56-1-G3](#) [ASMT-MW05-NMNS1](#) [KW DPLS33.KD-HIJG-D30D144-HN-22C2-120-S](#) [KW DDLM31.EH-5J6K-A737-W4A4-140-R18](#) [GW](#)  
[JTLRS1.CM-K1LW-XX57-1-100-Q-R33](#) [KW DDLM31.EH-5J6K-A636-W4A4-140-R18](#) [KW DDLM31.EH-5J6K-A131-W4A4-140-R18](#)  
[GW PSLT33.PM-LYL3-XX57-1-G3](#) [SML-LXL8047MWCTR/3](#) [L2C5-40HG1203E0900](#) [JB3030AWT-P-U27EA0000-N0000001](#)  
[JK3030AWT-P-U30EA0000-N0000001](#) [JK3030AWT-P-B40EB0000-N0000001](#) [JK3030AWT-P-H30EB0000-N0000001](#) [JK3030AWT-P-](#)  
[H40EB0000-N0000001](#) [JK3030AWT-P-U27EB0000-N0000001](#) [JK3030AWT-P-U30EB0000-N0000001](#) [XPGBWT-HE-0000-00JE5](#) [GW](#)  
[CSSRM2.PM-N3N5-XX53-1](#) [GW P9LMS1.EM-NRNU-30S7-0-200-R18](#) [GW PSLPS1.EC-KSKU-5R8T-1](#) [LTPL-M03614ZS50-F1](#) [LTW-](#)  
[2835SZK65](#) [LTW-3030AQL40](#) [LTW-3030AZL40-EU](#) [LTW-3030BSL42](#) [LTW-3030DZL30](#) [LTW-3030SZK40](#) [LTW-3030SZK65](#)