

Superior Efficacy & Lumen output with Small Form Factor

## Z Power LED – Z5-M2

**SZ5-M2-WX-XX (Cool, Neutral, Warm)**

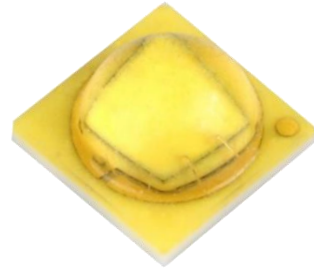

## Product Brief

### Description

- The Z-Power series is designed for high flux output applications with high current operation capability.
- It incorporates state of the art SMD design and low thermal resistant material.
- The Z Power LED is ideal light sources for directional lighting applications such as Spot Lights, various outdoor applications, automotive lightings and high performance torches .

### Features and Benefits

- High Lumen Output and Efficacy
- Designed for high current operation
- Low Thermal Resistance
- Wide CCT range 2600~7000K
- High Color quality with CRI Min.80(R9>0)
- ANSI compliant Binning
- MacAdam 3 Step
- RoHS compliant

### Key Applications

- Architectural
- Industrial
- Outdoor area
- Exterior Lighting
- Commercial

**Table 1. Product Selection Table**

Part Number	CCT			CRI
	Color	Min.	Max.	Min
SZ5-M2-W0-00	Cool White	4700K	7000K	70
SZ5-M2-W0-C8	Cool White	4700K	8200K	80
SZ5-M2-WN-00	Neutral White	3700K	4700K	70
SZ5-M2-WN-C8	Neutral White	3700K	4700K	80
SZ5-M2-WW-00	Warm White	2600K	3700K	70
SZ5-M2-WW-C8	Warm White	2600K	3700K	80
SZ5-M2-WW-C9	Warm White	2600K	3700K	90

---

# Table of Contents

<b>Index</b>	
• Product Brief	1
• Table of Contents	2
• Performance Characteristics	3
• Characteristics Graph	5
• Color Bin Structure	10
• Mechanical Dimensions	20
• Recommended Solder Pad	21
• Reflow Soldering Characteristics	22
• Packaging Information	23
• Product Nomenclature	25
• Handling of Silicone Resin for LEDs	26
• Precaution For Use	27
• Company Information	30

---

## Performance Characteristics

**Table 2. Product Selection Guide**

Part Number	CCT [K] <sup>[1]</sup>		Min. Luminous Flux <sup>[2]</sup> $\Phi_v$ <sup>[3]</sup> [lm] @ 350mA			Min. Luminous Flux <sup>[2]</sup> $\Phi_v$ <sup>[3]</sup> [lm] @ 85 °C			CRI <sup>[4]</sup> , R <sub>a</sub>
	Min.	Max.	Group	Flux [lm] @85 °C	Flux [lm] @25 °C	700mA	1000mA	1500mA	Min.
SZ5-M2-W0-00	4,700	7,000	W2	144	160	256	331	437	70
			W3	153	170	272	352	464	
			W4	160	178	285	368	485	
			W5	168	187	299	386	509	
SZ5-M2-W0-C8	4,700	8,200	V3	123	140	218	284	374	80
			W1	135	150	240	311	410	
			W2	144	160	256	331	437	
			W3	153	170	272	352	464	
SZ5-M2-WN-00	3,700	4,700	W1	135	150	240	311	410	70
			W2	144	160	256	331	437	
			W3	153	170	272	352	464	
			W4	160	178	285	368	485	
SZ5-M2-WN-C8	3,700	4,700	V1	104	118.5	185	241	316	80
			V2	114	130	203	264	347	
			V3	123	140	218	284	374	
			W1	135	150	240	311	410	
SZ5-M2-WW-00	2,600	3,700	V2	114	130	203	264	347	70
			V3	123	140	218	284	374	
			W1	135	150	240	311	410	
			W2	144	160	256	331	437	
SZ5-M2-WW-C8	2,600	3,700	V1	104	118.5	185	241	316	80
			V2	114	130	203	264	347	
			V3	123	140	218	284	374	

**Notes :** (1) Correlated Color Temperature is derived from the CIE 1931 Chromaticity diagram.

Color coordinate :  $\pm 0.005$ , CCT  $\pm 5\%$  tolerance.

(2) Seoul Semiconductor maintains a tolerance of  $\pm 7\%$  on flux and power measurements.

(3)  $\Phi_v$  is the total luminous flux output as measured with an integrating sphere.

(4) Tolerance is  $\pm 2.0$  on CRI measurements.

## Performance Characteristics

**Table 2. Product Selection Guide**

Part Number	CCT [K] <sup>[1]</sup>		Min. Luminous Flux <sup>[2]</sup> $\Phi_v$ <sup>[3]</sup> [lm] @ 350mA			Min. Luminous Flux <sup>[2]</sup> $\Phi_v$ <sup>[3]</sup> [lm] @ 85 °C			CRI <sup>[4]</sup> , R <sub>a</sub>
	Min.	Max.	Group	Flux [lm] @85 °C	Flux [lm] @25 °C	700mA	1000mA	1500mA	Min.
SZ5-M2-WW-C9	2,600	3,700	U1	82	91	132	173	217	90
			U2	90	100	145	189	238	
			U3	99	109	159	208	262	
			V1	104	118.5	185	241	316	

**Notes :** (1) Correlated Color Temperature is derived from the CIE 1931 Chromaticity diagram.

Color coordinate :  $\pm 0.005$ , CCT  $\pm 5\%$  tolerance.

(2) Seoul Semiconductor maintains a tolerance of  $\pm 7\%$  on flux and power measurements.

(3)  $\Phi_v$  is the total luminous flux output as measured with an integrating sphere.

(4) Tolerance is  $\pm 2.0$  on CRI measurements.

## Performance Characteristics

**Table 3. Characteristics**

Parameter	Symbol	Value			Unit
		Min.	Typ.	Max.	
Forward Current <sup>[1]</sup>	$I_F$	-	-	1500	mA
Peak Pulsed Forward Current <sup>[2]</sup>	$I_F$			2000	mA
Reverse Voltage	$V_R$	-	-	5	V
Power Dissipation	$P_D$	-	-	5.22	W
Forward Voltage (@700mA, 85°C)	$V_F$	-	-	3.0	V
Junction Temperature	$T_j$	-	-	150	°C
Operating Temperature	$T_{opr}$	- 40	-	125	°C
Storage Temperature	$T_{stg}$	- 40	-	125	°C
Viewing angle	$\theta$		118		degree
Thermal resistance (J to S) <sup>[3]</sup>	$R\theta_{J-S}$	-	3.45	-	K/W
ESD Sensitivity(HBM) <sup>[4]</sup>		Class 3A JESD22-A114-E			

**Notes :**

- (1) At Junction Temperature 85 °C condition.
  - (2) Pulse width ≤10ms, duty cycle ≤ 10% condition.
  - (3)  $R\theta_{J-S}$  is tested at 700mA.
  - (4) The zener diode is included to protect the product from ESD.
- Thermal resistance can be increased substantially depending on the heat sink design/operating condition, and the maximum possible driving current will decrease accordingly.

## Characteristics Graph

Fig 1. Color Spectrum,  $T_j=25^\circ\text{C}$

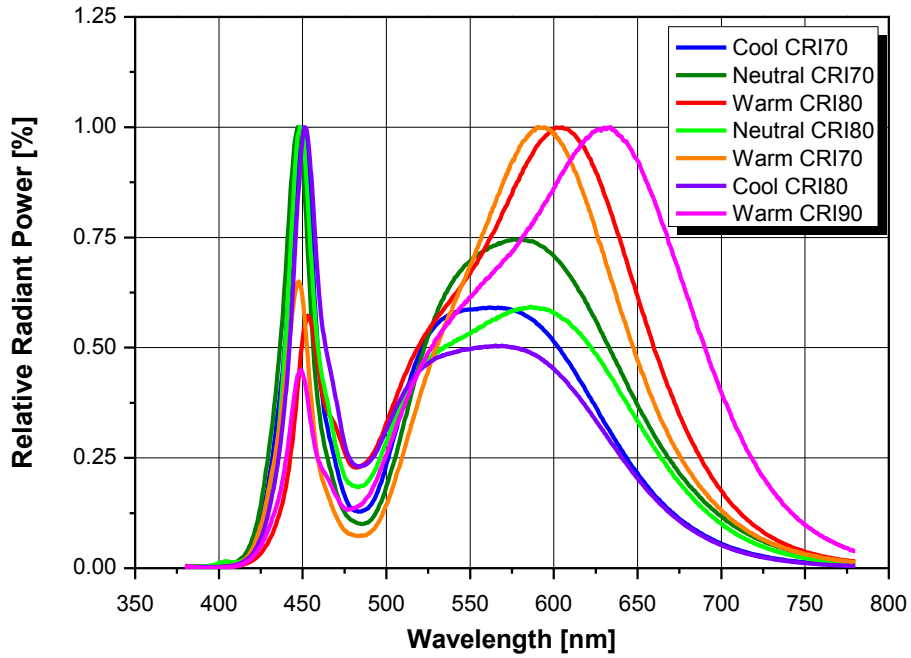
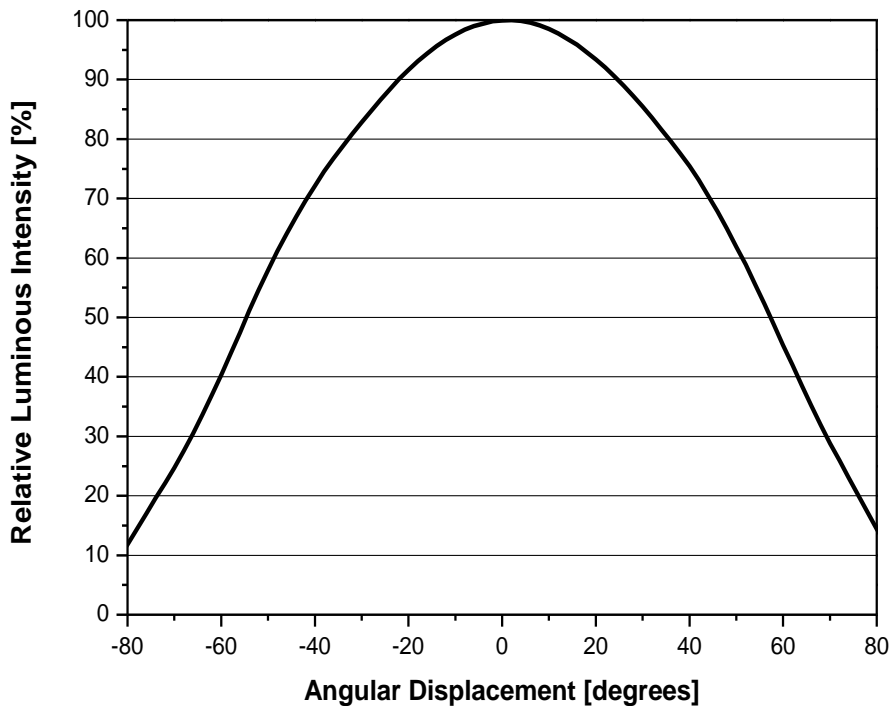
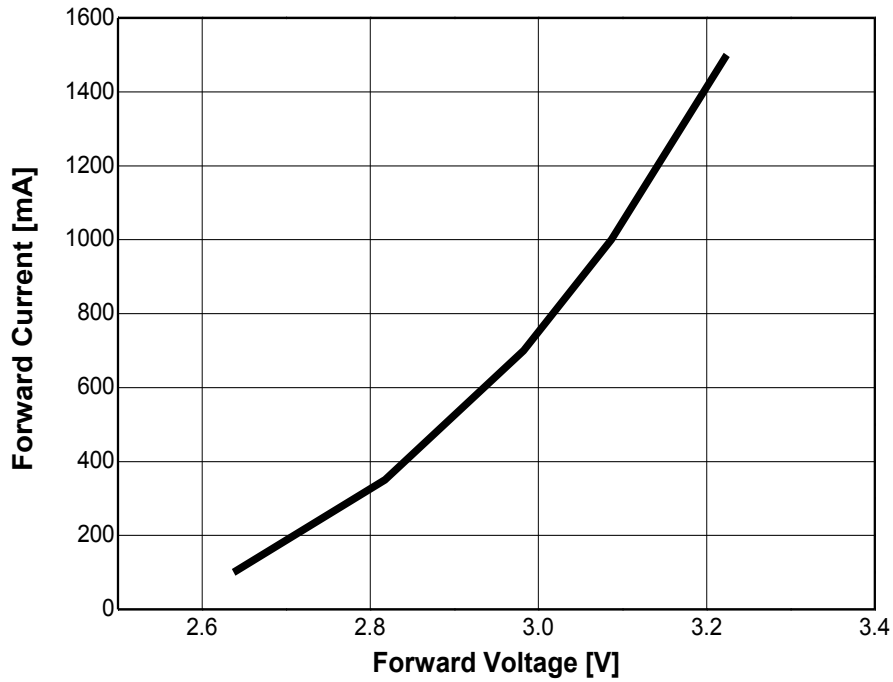

Fig 2. Typical Spatial Distribution



## Characteristics Graph

**Fig 3. Forward Voltage vs. Forward Current,  $T_j=85^\circ\text{C}$**



**Fig 4. Forward Current vs. Relative Luminous Flux,  $T_j=85^\circ\text{C}$**

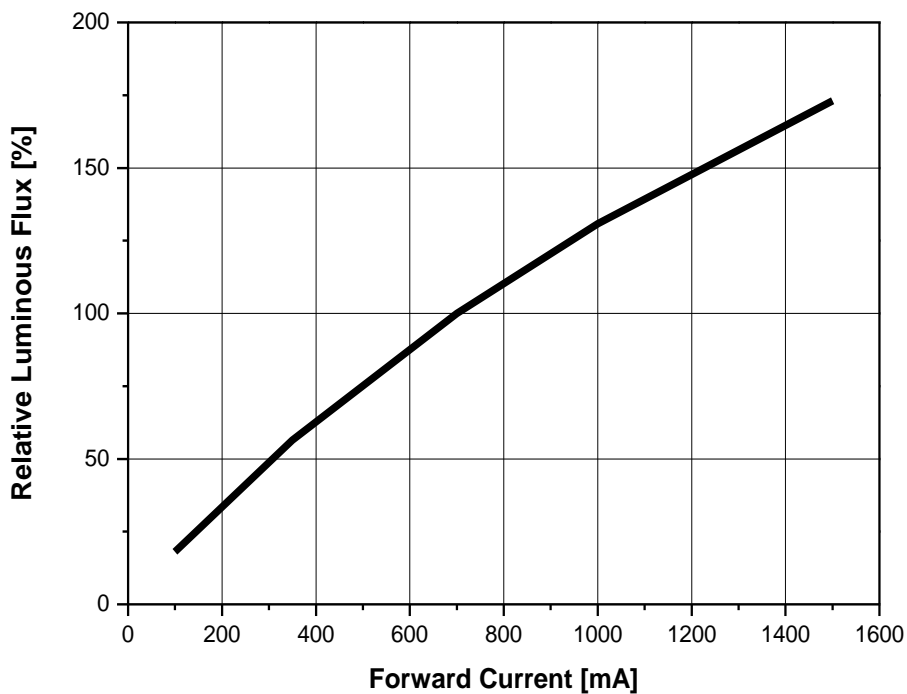

## Characteristics Graph

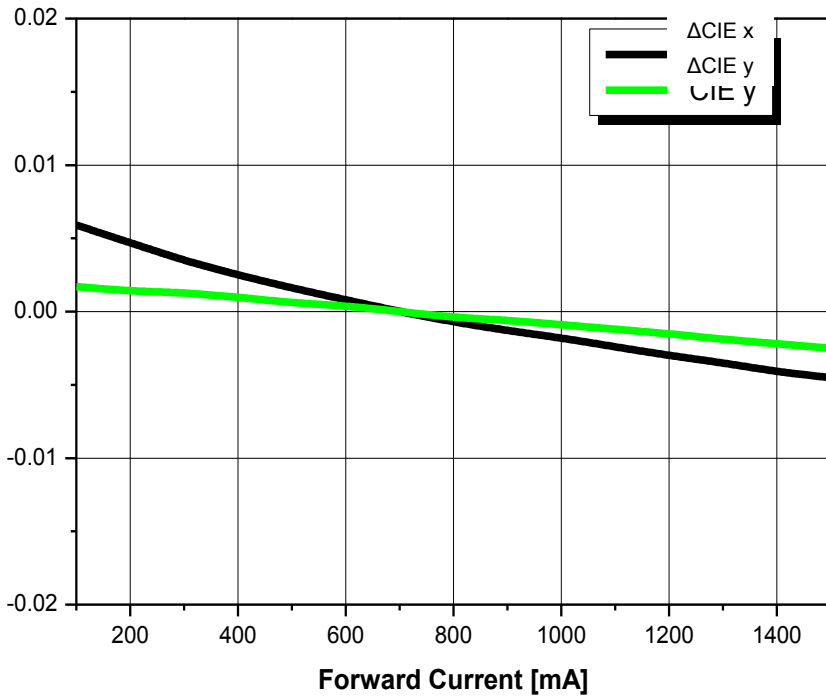
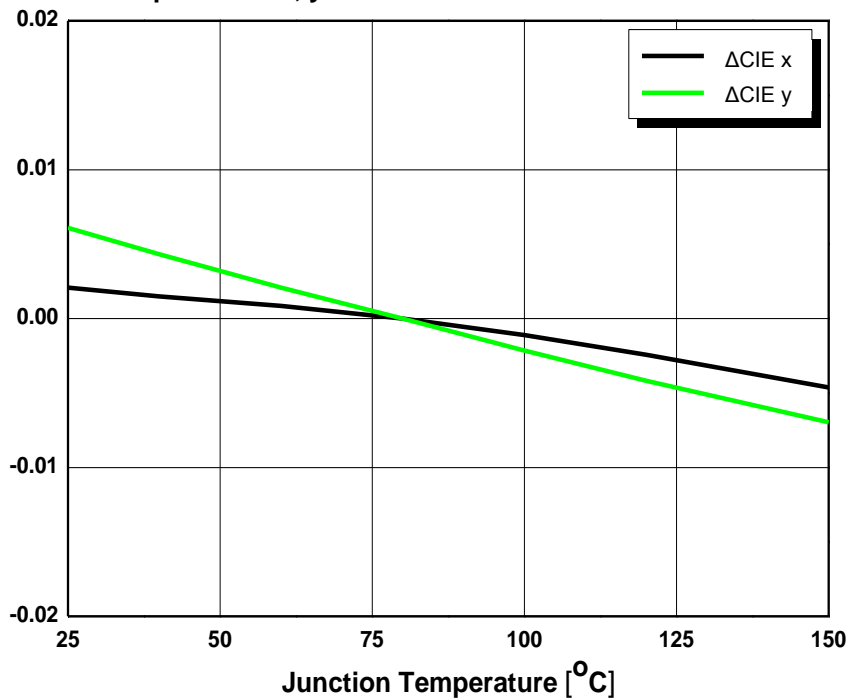
**Fig 5. Forward Current vs CIE x, y Shift**

**Fig 6. Junction Temp. vs. CIE x, y Shift**



## Characteristics Graph

Fig 7. Relative Light Output vs. Junction Temperature,  $I_F = 350\text{mA}$

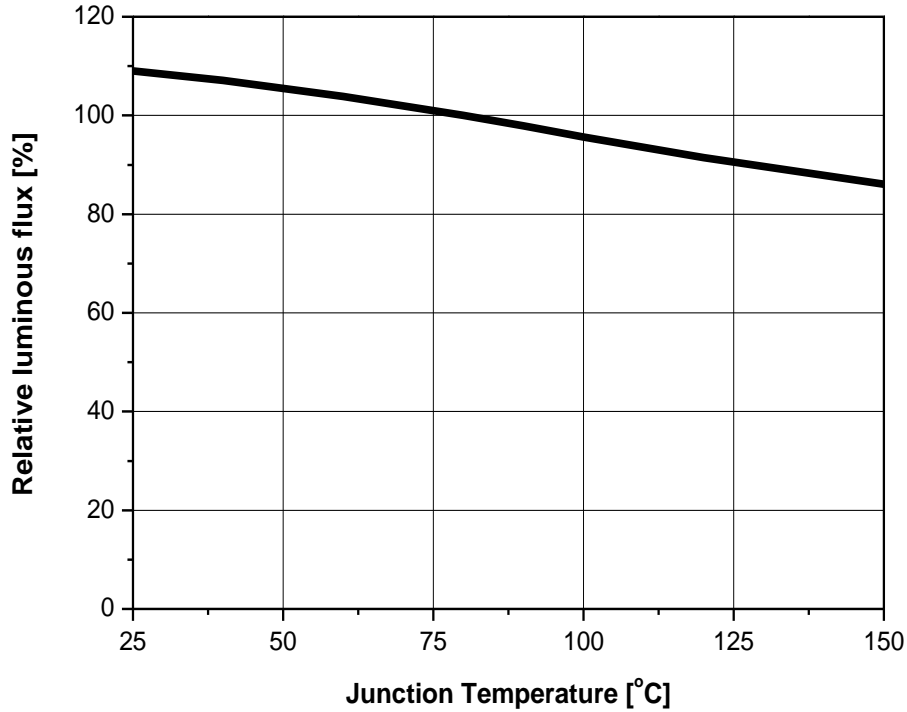
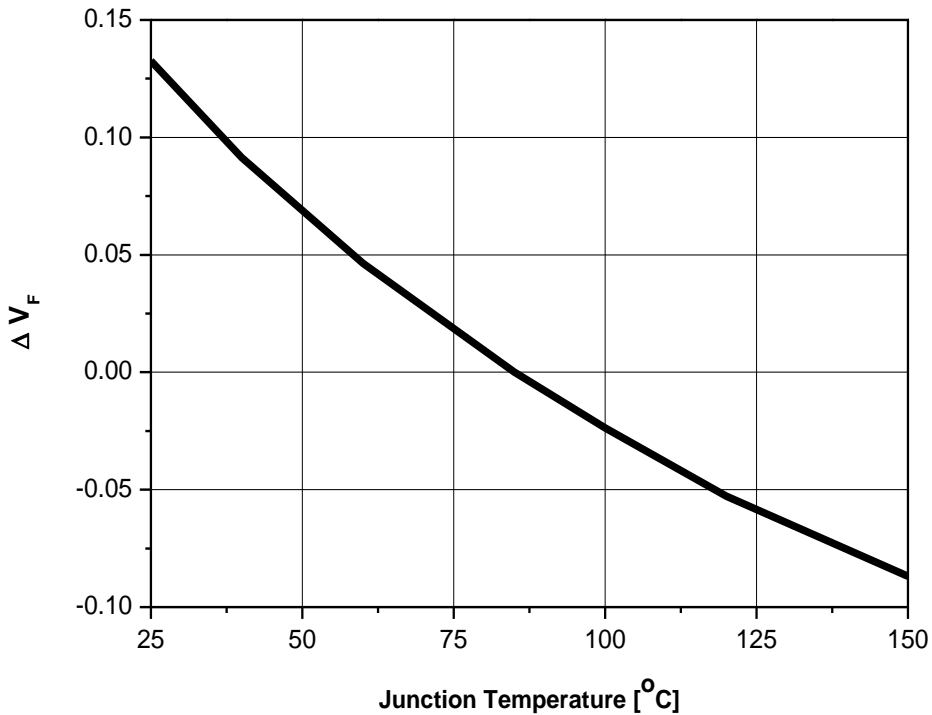
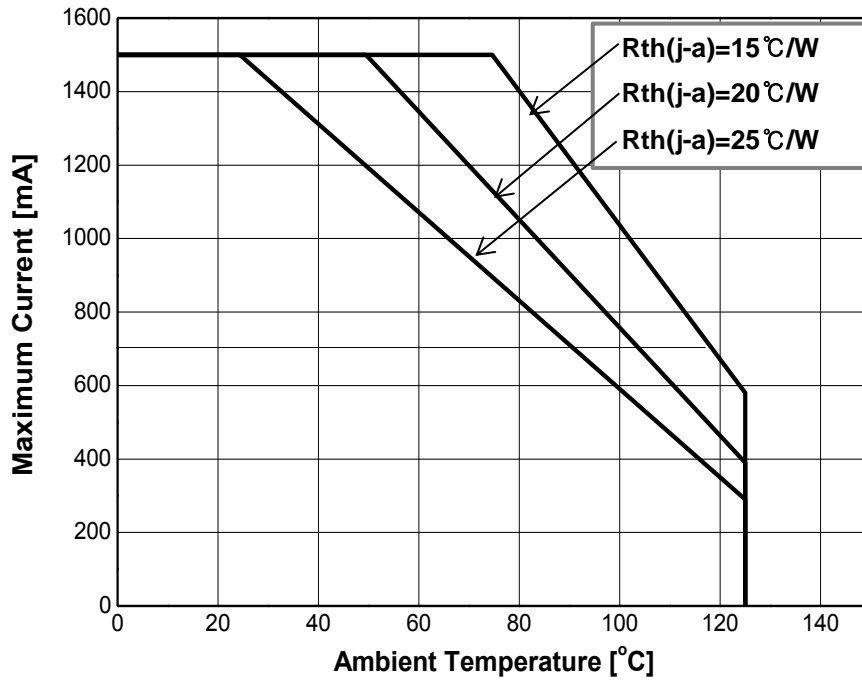

Fig 8. Relative Forward vs. Junction Temperature,  $I_F = 350\text{mA}$



## Characteristics Graph

Fig 9. Maximum Forward Current vs. Ambient Temperature,  $T_j(\text{max.})=150^\circ\text{C}$ ,  $I_F=1500\text{mA}$



## Color Bin Structure

**Table 4. Bin Code description,  $I_F=700\text{mA}$ ,  $T_J=85^\circ\text{C}$** 

Part Number	Luminous Flux [lm]*			Color Chromaticity Coordinate	Typical Forward Voltage [V <sub>F</sub> ] <sup>[1]</sup>		
	Bin Code	Min.	Max.		Bin Code	Min.	Max.
SZ5-M2-W0-00	W2	256	272	Refer to page. 12~14	G	2.75	3.0
	W3	272	285				
	W4	285	299				
	W5	299	313				
SZ5-M2-W0-C8	V3	218	240	Refer to page. 12~14	G	2.75	3.0
	W1	240	256				
	W2	256	272				
	W3	272	285				
SZ5-M2-WN-00	W1	240	256	Refer to page. 15~16	G	2.75	3.0
	W2	256	272				
	W3	272	285				
	W4	285	299				
SZ5-M2-WN-C8	V1	185	203	Refer to page. 15~16	G	2.75	3.0
	V2	203	218				
	V3	218	240				
	W1	240	256				
SZ5-M2-WW-00	V2	203	218	Refer to page. 17~19	G	2.75	3.0
	V3	218	240				
	W1	240	256				
	W2	256	272				
SZ5-M2-WW-C8	V1	185	203	Refer to page. 17~19	G	2.75	3.0
	V2	203	218				
	V3	218	240				
SZ5-M2-WW-C9	U1	132	145	Refer to page. 17~19	G	2.75	3.0
	U2	145	159				
	U3	159	185				
	V1	185	203				

**Notes :**

 (1) Tolerance is  $\pm 0.06\text{V}$  on forward voltage measurements.

## Color Bin Structure

**Table5. Flux Rank Distribution**

**CR170** Available Rank

CCT	CIE	Flux Rank						
6000 ~ 7000K	A	V2	V3	W1	W2	W3	W4	W5
5300 ~ 6000K	B	V2	V3	W1	W2	W3	W4	W5
4700 ~ 5300K	C	V2	V3	W1	W2	W3	W4	W5
4200 ~ 4700K	D	V2	V3	W1	W2	W3	W4	W5
3700 ~ 4200K	E	V2	V3	W1	W2	W3	W4	W5
3500 ~ 3700K	F	V2	V3	W1	W2	W3	W4	W5
2900 ~ 3200K	G	V2	V3	W1	W2	W3	W4	W5
2600 ~ 2900K	H	V2	V3	W1	W2	W3	W4	W5

**CR180** Available Rank

CCT	CIE	Flux Rank						
7000 ~ 8200K	Z	V1	V2	V3	W1	W2	W3	W4
6000 ~ 7000K	A	V1	V2	V3	W1	W2	W3	W4
5300 ~ 6000K	B	V1	V2	V3	W1	W2	W3	W4
4700 ~ 5300K	C	V1	V2	V3	W1	W2	W3	W4
4200 ~ 4700K	D	V1	V2	V3	W1	W2	W3	W4
3700 ~ 4200K	E	V1	V2	V3	W1	W2	W3	W4
3500 ~ 3700K	F	V1	V2	V3	W1	W2	W3	W4
2900 ~ 3200K	G	V1	V2	V3	W1	W2	W3	W4
2600 ~ 2900K	H	V1	V2	V3	W1	W2	W3	W4

**CR190** Available Rank

CCT	CIE	Flux Rank						
3500 ~ 3700K	F	U1	U2	U3	V1	V2	V3	W1
2900 ~ 3200K	G	U1	U2	U3	V1	V2	V3	W1
2600 ~ 2900K	H	U1	U2	U3	V1	V2	V3	W1

**Notes :**

 (1) Tolerance is  $\pm 0.06V$  on forward voltage measurements.

## Color Bin Structure

CIE Chromaticity Diagram,  $T_j=85^\circ\text{C}$ ,  $I_f=700\text{mA}$

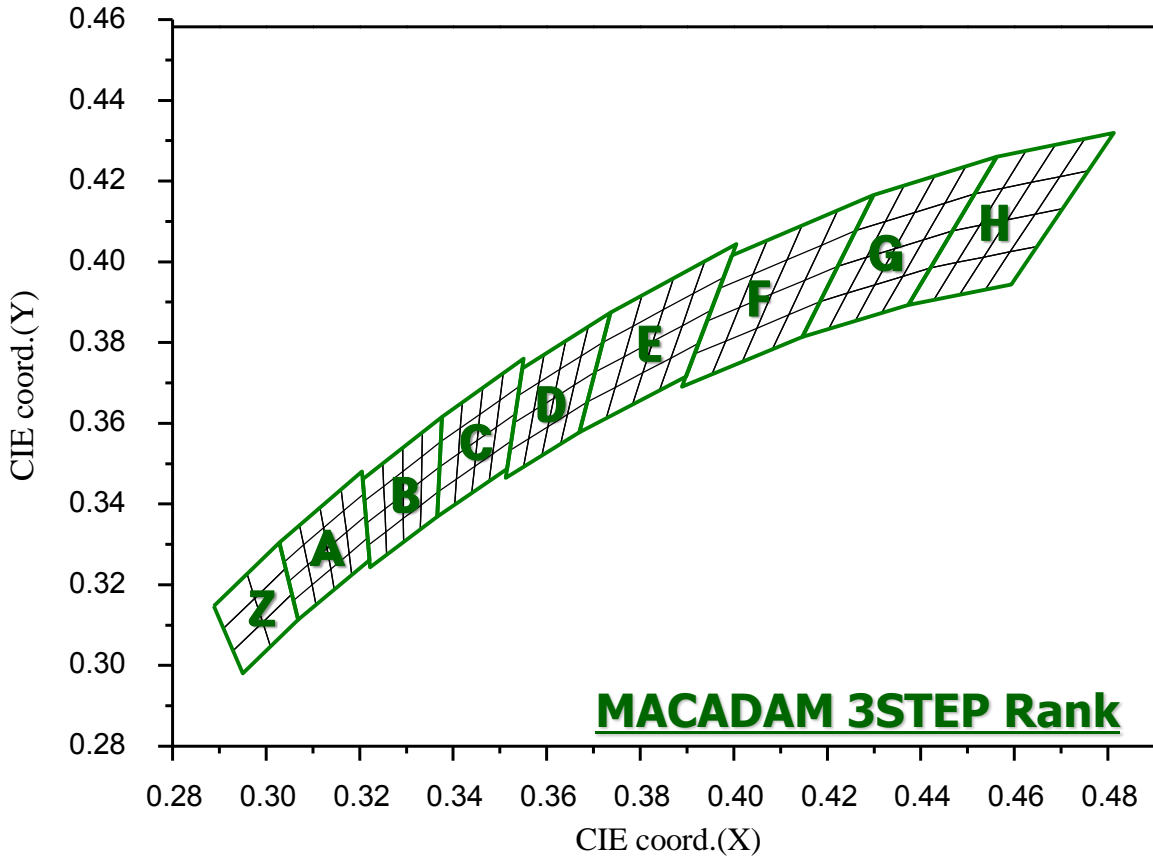

**\*Notes :**

- Energy Star binning applied to all 2600~7000K.
- Measurement Uncertainty of the Color Coordinates :  $\pm 0.005$

## Color Bin Structure

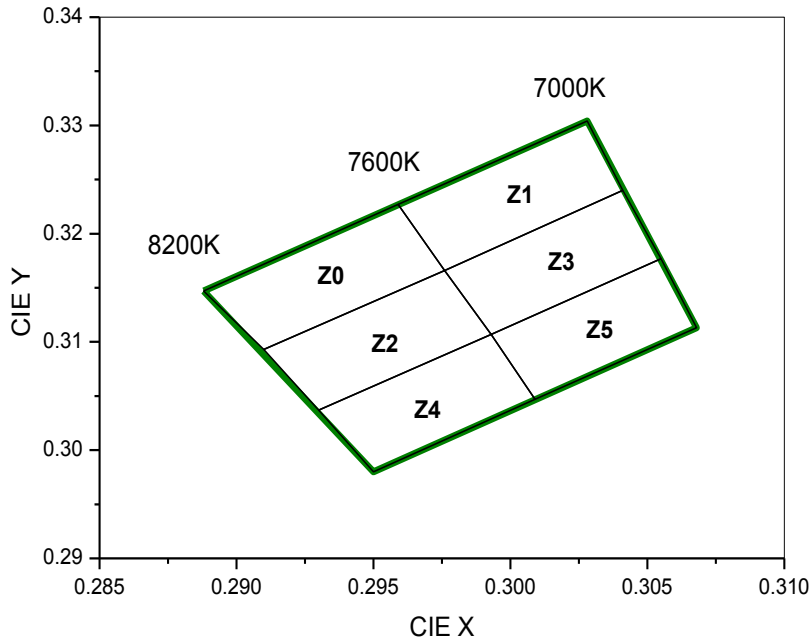
**CIE Chromaticity Diagram (Cool white),  $T_j=85^\circ\text{C}$ ,  $I_f=700\text{mA}$** 

Z0		Z1		Z2	
CIE X	CIE Y	CIE X	CIE Y	CIE X	CIE Y
0.2888	0.3147	0.2959	0.3227	0.291	0.3093
0.2959	0.3227	0.3028	0.3304	0.2976	0.3166
0.2976	0.3166	0.3041	0.324	0.2993	0.3107
0.291	0.3093	0.2976	0.3166	0.293	0.3037
Z3		Z4		Z5	
CIE X	CIE Y	CIE X	CIE Y	CIE X	CIE Y
0.2976	0.3166	0.293	0.3037	0.2993	0.3107
0.3041	0.324	0.2993	0.3107	0.3055	0.3177
0.3055	0.3177	0.3009	0.3047	0.3068	0.3113
0.2993	0.3107	0.295	0.298	0.3009	0.3047

## Color Bin Structure

CIE Chromaticity Diagram (Cool white),  $T_j=85^\circ\text{C}$ ,  $I_f=700\text{mA}$

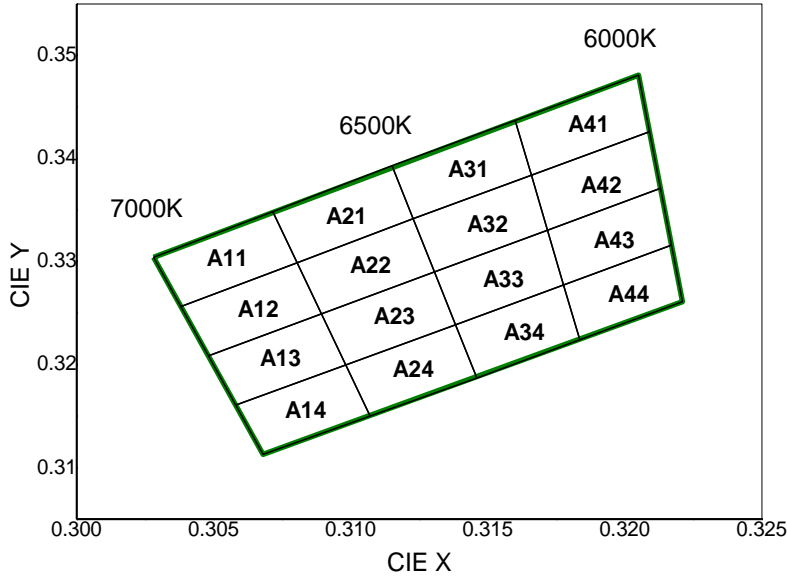

A11		A21		A31		A41	
CIE X	CIE Y	CIE X	CIE Y	CIE X	CIE Y	CIE X	CIE Y
0.3028	0.3304	0.3072	0.3349	0.3115	0.3393	0.3160	0.3437
0.3038	0.3256	0.3080	0.3299	0.3123	0.3342	0.3166	0.3384
0.3080	0.3299	0.3123	0.3342	0.3166	0.3384	0.3209	0.3426
0.3072	0.3349	0.3115	0.3393	0.3160	0.3437	0.3205	0.3481
A12		A22		A32		A42	
CIE X	CIE Y	CIE X	CIE Y	CIE X	CIE Y	CIE X	CIE Y
0.3038	0.3256	0.3080	0.3299	0.3123	0.3342	0.3166	0.3384
0.3048	0.3209	0.3089	0.3249	0.3131	0.3290	0.3172	0.3331
0.3089	0.3249	0.3131	0.3290	0.3172	0.3331	0.3213	0.3371
0.3080	0.3299	0.3123	0.3342	0.3166	0.3384	0.3209	0.3426
A13		A23		A33		A43	
CIE X	CIE Y	CIE X	CIE Y	CIE X	CIE Y	CIE X	CIE Y
0.3048	0.3209	0.3089	0.3249	0.3131	0.3290	0.3172	0.3331
0.3058	0.3161	0.3098	0.3200	0.3138	0.3239	0.3178	0.3277
0.3098	0.3200	0.3138	0.3239	0.3178	0.3277	0.3217	0.3316
0.3089	0.3249	0.3131	0.3290	0.3172	0.3331	0.3213	0.3371
A14		A24		A34		A44	
CIE X	CIE Y	CIE X	CIE Y	CIE X	CIE Y	CIE X	CIE Y
0.3058	0.3161	0.3098	0.3200	0.3138	0.3239	0.3178	0.3277
0.3068	0.3113	0.3107	0.3150	0.3146	0.3187	0.3184	0.3224
0.3107	0.3150	0.3146	0.3187	0.3184	0.3224	0.3221	0.3261
0.3098	0.3200	0.3138	0.3239	0.3178	0.3277	0.3217	0.3316

## Color Bin Structure

CIE Chromaticity Diagram (Cool white),  $T_j=85^\circ\text{C}$ ,  $I_f=700\text{mA}$

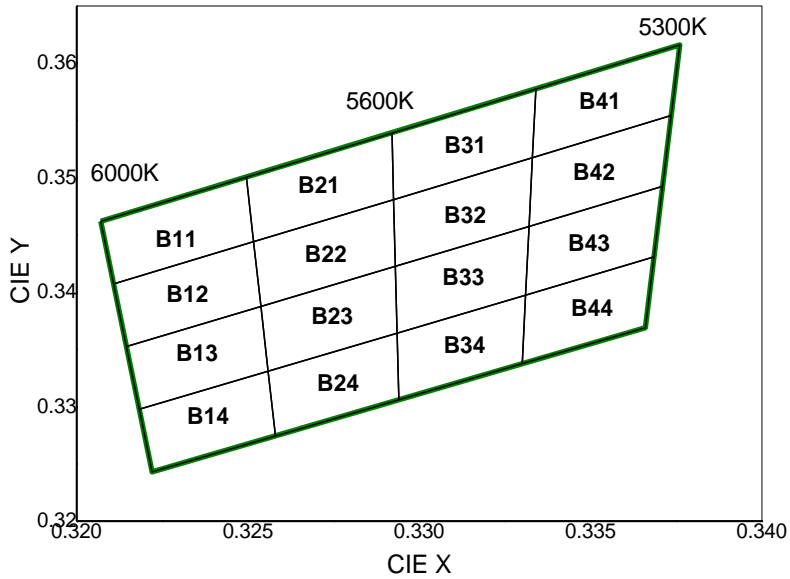

B11		B21		B31		B41	
CIE X	CIE Y	CIE X	CIE Y	CIE X	CIE Y	CIE X	CIE Y
0.3207	0.3462	0.3250	0.3501	0.3292	0.3539	0.3334	0.3578
0.3211	0.3407	0.3252	0.3444	0.3293	0.3481	0.3333	0.3518
0.3252	0.3444	0.3293	0.3481	0.3333	0.3518	0.3374	0.3554
0.3250	0.3501	0.3292	0.3539	0.3334	0.3578	0.3376	0.3616
B12		B22		B32		B42	
CIE X	CIE Y	CIE X	CIE Y	CIE X	CIE Y	CIE X	CIE Y
0.3211	0.3407	0.3252	0.3444	0.3293	0.3481	0.3333	0.3518
0.3215	0.3353	0.3254	0.3388	0.3293	0.3423	0.3332	0.3458
0.3254	0.3388	0.3293	0.3423	0.3332	0.3458	0.3371	0.3493
0.3252	0.3444	0.3293	0.3481	0.3333	0.3518	0.3374	0.3554
B13		B23		B33		B43	
CIE X	CIE Y	CIE X	CIE Y	CIE X	CIE Y	CIE X	CIE Y
0.3215	0.3353	0.3254	0.3388	0.3293	0.3423	0.3332	0.3458
0.3218	0.3298	0.3256	0.3331	0.3294	0.3364	0.3331	0.3398
0.3256	0.3331	0.3294	0.3364	0.3331	0.3398	0.3369	0.3431
0.3254	0.3388	0.3293	0.3423	0.3332	0.3458	0.3371	0.3493
B14		B24		B34		B44	
CIE X	CIE Y	CIE X	CIE Y	CIE X	CIE Y	CIE X	CIE Y
0.3218	0.3298	0.3256	0.3331	0.3294	0.3364	0.3331	0.3398
0.3222	0.3243	0.3258	0.3275	0.3294	0.3306	0.3330	0.3338
0.3258	0.3275	0.3294	0.3306	0.3330	0.3338	0.3366	0.3369
0.3256	0.3331	0.3294	0.3364	0.3331	0.3398	0.3369	0.3431

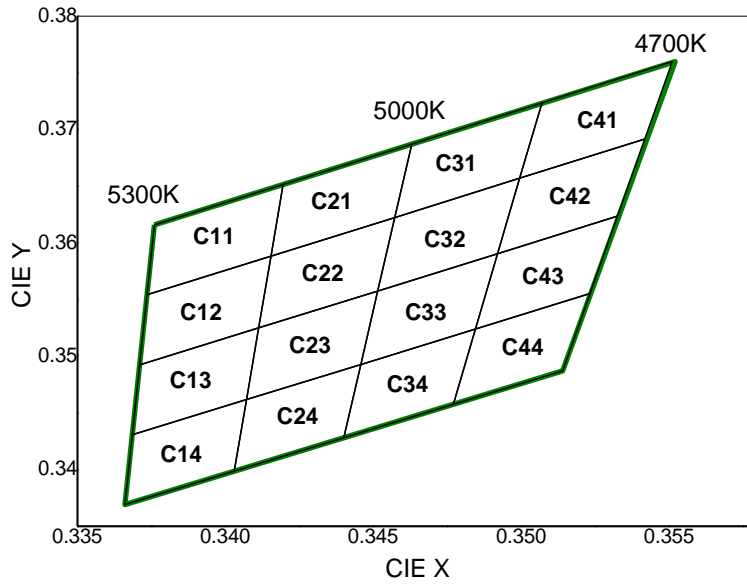

## Color Bin Structure

**CIE Chromaticity Diagram (Cool white),  $T_j=85^\circ\text{C}$ ,  $I_f=700\text{mA}$** 

C11		C21		C31		C41	
CIE X	CIE Y	CIE X	CIE Y	CIE X	CIE Y	CIE X	CIE Y
0.3376	0.3616	0.3420	0.3652	0.3463	0.3687	0.3507	0.3724
0.3374	0.3554	0.3415	0.3588	0.3457	0.3622	0.3500	0.3657
0.3415	0.3588	0.3457	0.3622	0.3500	0.3657	0.3542	0.3692
0.3420	0.3652	0.3463	0.3687	0.3507	0.3724	0.3551	0.3760
C12		C22		C32		C42	
CIE X	CIE Y	CIE X	CIE Y	CIE X	CIE Y	CIE X	CIE Y
0.3374	0.3554	0.3415	0.3588	0.3457	0.3622	0.3500	0.3657
0.3371	0.3493	0.3411	0.3525	0.3452	0.3558	0.3492	0.3591
0.3411	0.3525	0.3452	0.3558	0.3492	0.3591	0.3533	0.3624
0.3415	0.3588	0.3457	0.3622	0.3500	0.3657	0.3542	0.3692
C13		C23		C33		C43	
CIE X	CIE Y	CIE X	CIE Y	CIE X	CIE Y	CIE X	CIE Y
0.3371	0.3493	0.3411	0.3525	0.3452	0.3558	0.3492	0.3591
0.3369	0.3431	0.3407	0.3462	0.3446	0.3493	0.3485	0.3524
0.3407	0.3462	0.3446	0.3493	0.3485	0.3524	0.3523	0.3555
0.3411	0.3525	0.3452	0.3558	0.3492	0.3591	0.3533	0.3624
C14		C24		C34		C44	
CIE X	CIE Y	CIE X	CIE Y	CIE X	CIE Y	CIE X	CIE Y
0.3369	0.3431	0.3407	0.3462	0.3446	0.3493	0.3485	0.3524
0.3366	0.3369	0.3403	0.3399	0.3440	0.3428	0.3477	0.3458
0.3403	0.3399	0.3440	0.3428	0.3477	0.3458	0.3514	0.3487
0.3407	0.3462	0.3446	0.3493	0.3485	0.3524	0.3523	0.3555

## Color Bin Structure

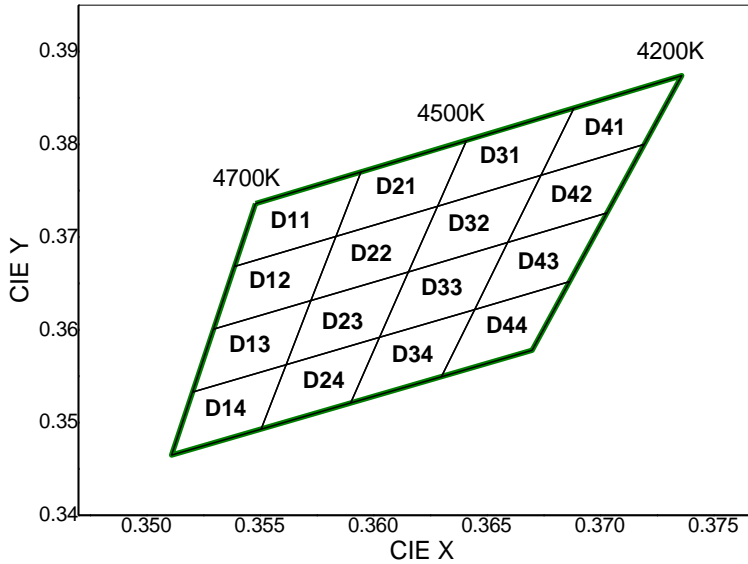
**CIE Chromaticity Diagram (Neutral White),  $T_j=85^\circ\text{C}$ ,  $I_f=700\text{mA}$** 

D11		D21		D31		D41	
CIE X	CIE Y	CIE X	CIE Y	CIE X	CIE Y	CIE X	CIE Y
0.3548	0.3736	0.3595	0.3770	0.3641	0.3804	0.3689	0.3839
0.3539	0.3668	0.3584	0.3701	0.3628	0.3733	0.3674	0.3767
0.3584	0.3701	0.3628	0.3733	0.3674	0.3767	0.3720	0.3800
0.3595	0.3770	0.3641	0.3804	0.3689	0.3839	0.3736	0.3874
D12		D22		D32		D42	
CIE X	CIE Y	CIE X	CIE Y	CIE X	CIE Y	CIE X	CIE Y
0.3539	0.3668	0.3584	0.3701	0.3628	0.3733	0.3674	0.3767
0.3530	0.3601	0.3573	0.3632	0.3616	0.3663	0.3659	0.3694
0.3573	0.3632	0.3616	0.3663	0.3659	0.3694	0.3703	0.3726
0.3584	0.3701	0.3628	0.3733	0.3674	0.3767	0.3720	0.3800
D13		D23		D33		D43	
CIE X	CIE Y	CIE X	CIE Y	CIE X	CIE Y	CIE X	CIE Y
0.3530	0.3601	0.3573	0.3632	0.3616	0.3663	0.3659	0.3694
0.3520	0.3533	0.3562	0.3562	0.3603	0.3592	0.3645	0.3622
0.3562	0.3562	0.3603	0.3592	0.3645	0.3622	0.3687	0.3652
0.3573	0.3632	0.3616	0.3663	0.3659	0.3694	0.3703	0.3726
D14		D24		D34		D44	
CIE X	CIE Y	CIE X	CIE Y	CIE X	CIE Y	CIE X	CIE Y
0.3520	0.3533	0.3562	0.3562	0.3603	0.3592	0.3645	0.3622
0.3511	0.3465	0.3551	0.3493	0.3590	0.3521	0.3630	0.3550
0.3551	0.3493	0.3590	0.3521	0.3630	0.3550	0.3670	0.3578
0.3562	0.3562	0.3603	0.3592	0.3645	0.3622	0.3687	0.3652

## Color Bin Structure

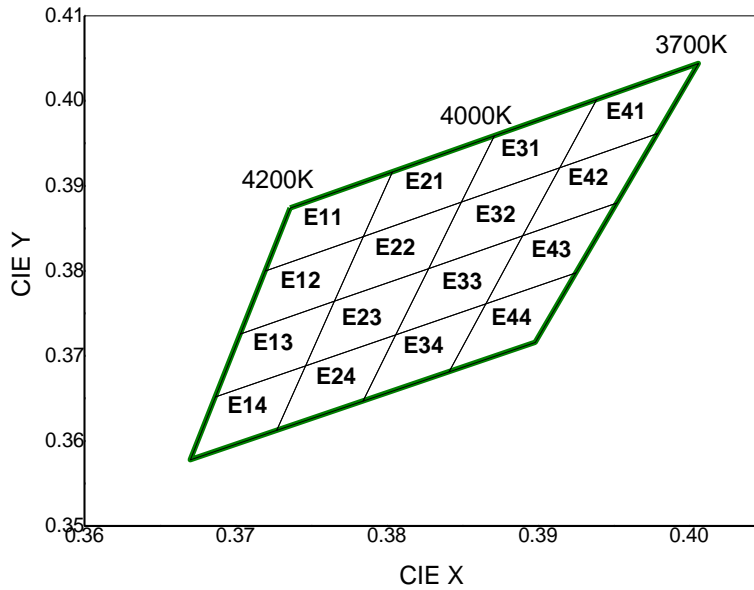
**CIE Chromaticity Diagram (Neutral White),  $T_j=85^\circ\text{C}$ ,  $I_f=700\text{mA}$** 

E11		E21		E31		E41	
CIE X	CIE Y	CIE X	CIE Y	CIE X	CIE Y	CIE X	CIE Y
0.3736	0.3874	0.3804	0.3917	0.3871	0.3959	0.3939	0.4002
0.3720	0.3800	0.3784	0.3841	0.3849	0.3881	0.3914	0.3922
0.3784	0.3841	0.3849	0.3881	0.3914	0.3922	0.3979	0.3962
0.3804	0.3917	0.3871	0.3959	0.3939	0.4002	0.4006	0.4044
E12		E22		E32		E42	
CIE X	CIE Y	CIE X	CIE Y	CIE X	CIE Y	CIE X	CIE Y
0.3720	0.3800	0.3784	0.3841	0.3849	0.3881	0.3914	0.3922
0.3703	0.3726	0.3765	0.3765	0.3828	0.3803	0.3890	0.3842
0.3765	0.3765	0.3828	0.3803	0.3890	0.3842	0.3952	0.3880
0.3784	0.3841	0.3849	0.3881	0.3914	0.3922	0.3979	0.3962
E13		E23		E33		E43	
CIE X	CIE Y	CIE X	CIE Y	CIE X	CIE Y	CIE X	CIE Y
0.3703	0.3726	0.3765	0.3765	0.3828	0.3803	0.3890	0.3842
0.3687	0.3652	0.3746	0.3689	0.3806	0.3725	0.3865	0.3762
0.3746	0.3689	0.3806	0.3725	0.3865	0.3762	0.3925	0.3798
0.3765	0.3765	0.3828	0.3803	0.3890	0.3842	0.3952	0.3880
E14		E24		E34		E44	
CIE X	CIE Y	CIE X	CIE Y	CIE X	CIE Y	CIE X	CIE Y
0.3687	0.3652	0.3746	0.3689	0.3806	0.3725	0.3865	0.3762
0.3670	0.3578	0.3727	0.3613	0.3784	0.3647	0.3841	0.3682
0.3727	0.3613	0.3784	0.3647	0.3841	0.3682	0.3898	0.3716
0.3746	0.3689	0.3806	0.3725	0.3865	0.3762	0.3925	0.3798

## Color Bin Structure

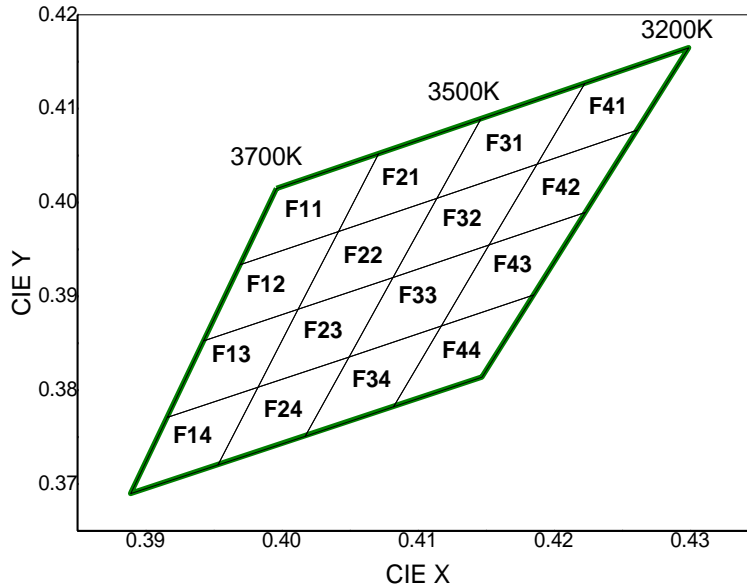
**CIE Chromaticity Diagram (Warm White),  $T_j=85^\circ\text{C}$ ,  $I_F=700\text{mA}$** 

F11		F21		F31		F41	
CIE X	CIE Y	CIE X	CIE Y	CIE X	CIE Y	CIE X	CIE Y
0.3996	0.4015	0.4071	0.4052	0.4146	0.4089	0.4223	0.4127
0.3969	0.3934	0.4042	0.3969	0.4114	0.4005	0.4187	0.4041
0.4042	0.3969	0.4114	0.4005	0.4187	0.4041	0.4261	0.4077
0.4071	0.4052	0.4146	0.4089	0.4223	0.4127	0.4299	0.4165
F12		F22		F32		F42	
CIE X	CIE Y	CIE X	CIE Y	CIE X	CIE Y	CIE X	CIE Y
0.3969	0.3934	0.4042	0.3969	0.4114	0.4005	0.4187	0.4041
0.3943	0.3853	0.4012	0.3886	0.4082	0.3920	0.4152	0.3955
0.4012	0.3886	0.4082	0.3920	0.4152	0.3955	0.4223	0.3990
0.4042	0.3969	0.4114	0.4005	0.4187	0.4041	0.4261	0.4077
F13		F23		F33		F43	
CIE X	CIE Y	CIE X	CIE Y	CIE X	CIE Y	CIE X	CIE Y
0.3943	0.3853	0.4012	0.3886	0.4082	0.3920	0.4152	0.3955
0.3916	0.3771	0.3983	0.3803	0.4049	0.3836	0.4117	0.3869
0.3983	0.3803	0.4049	0.3836	0.4117	0.3869	0.4185	0.3902
0.4012	0.3886	0.4082	0.3920	0.4152	0.3955	0.4223	0.3990
F14		F24		F34		F44	
CIE X	CIE Y	CIE X	CIE Y	CIE X	CIE Y	CIE X	CIE Y
0.3916	0.3771	0.3983	0.3803	0.4049	0.3836	0.4117	0.3869
0.3889	0.3690	0.3953	0.3721	0.4017	0.3751	0.4082	0.3783
0.3953	0.3721	0.4017	0.3751	0.4082	0.3783	0.4147	0.3814
0.3983	0.3803	0.4049	0.3836	0.4117	0.3869	0.4185	0.3902

## Color Bin Structure

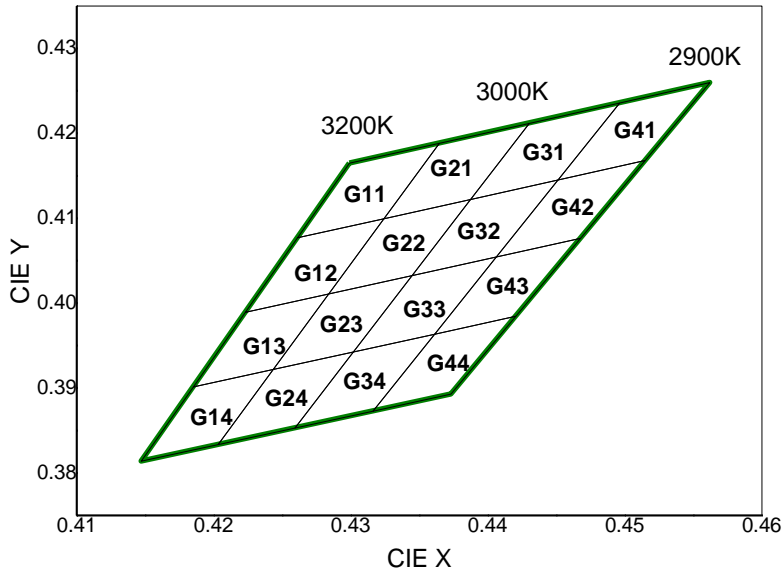
**CIE Chromaticity Diagram (Warm White),  $T_j=85^\circ\text{C}$ ,  $I_F=700\text{mA}$** 

G11		G21		G31		G41	
CIE X	CIE Y	CIE X	CIE Y	CIE X	CIE Y	CIE X	CIE Y
0.4299	0.4165	0.4364	0.4188	0.4430	0.4212	0.4496	0.4236
0.4261	0.4077	0.4324	0.4099	0.4387	0.4122	0.4451	0.4145
0.4324	0.4100	0.4387	0.4122	0.4451	0.4145	0.4514	0.4168
0.4365	0.4189	0.4430	0.4212	0.4496	0.4236	0.4562	0.4260
G12		G22		G32		G42	
CIE X	CIE Y	CIE X	CIE Y	CIE X	CIE Y	CIE X	CIE Y
0.4261	0.4077	0.4324	0.4100	0.4387	0.4122	0.4451	0.4145
0.4223	0.3990	0.4284	0.4011	0.4345	0.4033	0.4406	0.4055
0.4284	0.4011	0.4345	0.4033	0.4406	0.4055	0.4468	0.4077
0.4324	0.4100	0.4387	0.4122	0.4451	0.4145	0.4515	0.4168
G13		G23		G33		G43	
CIE X	CIE Y	CIE X	CIE Y	CIE X	CIE Y	CIE X	CIE Y
0.4223	0.3990	0.4284	0.4011	0.4345	0.4033	0.4406	0.4055
0.4185	0.3902	0.4243	0.3922	0.4302	0.3943	0.4361	0.3964
0.4243	0.3922	0.4302	0.3943	0.4361	0.3964	0.4420	0.3985
0.4284	0.4011	0.4345	0.4033	0.4406	0.4055	0.4468	0.4077
G14		G24		G34		G44	
CIE X	CIE Y	CIE X	CIE Y	CIE X	CIE Y	CIE X	CIE Y
0.4243	0.3922	0.4302	0.3943	0.4302	0.3943	0.4361	0.3964
0.4203	0.3834	0.4259	0.3853	0.4259	0.3853	0.4316	0.3873
0.4147	0.3814	0.4203	0.3834	0.4316	0.3873	0.4373	0.3893
0.4185	0.3902	0.4243	0.3922	0.4361	0.3964	0.4420	0.3985

## Color Bin Structure

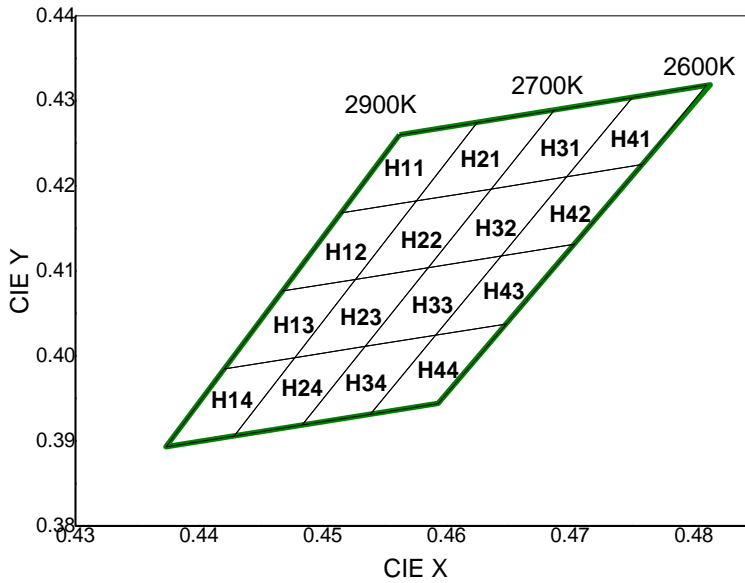
**CIE Chromaticity Diagram (Warm White),  $T_j=85^\circ\text{C}$ ,  $I_f=700\text{mA}$** 

H11		H21		H31		H41	
CIE X	CIE Y	CIE X	CIE Y	CIE X	CIE Y	CIE X	CIE Y
0.4562	0.4260	0.4625	0.4275	0.4687	0.4289	0.4750	0.4304
0.4515	0.4168	0.4575	0.4182	0.4636	0.4197	0.4697	0.4211
0.4575	0.4182	0.4636	0.4197	0.4697	0.4211	0.4758	0.4225
0.4625	0.4275	0.4687	0.4289	0.4750	0.4304	0.4810	0.4319
H12		H22		H32		H42	
CIE X	CIE Y	CIE X	CIE Y	CIE X	CIE Y	CIE X	CIE Y
0.4515	0.4168	0.4575	0.4182	0.4636	0.4197	0.4697	0.4211
0.4468	0.4077	0.4526	0.4090	0.4585	0.4104	0.4644	0.4118
0.4526	0.4090	0.4585	0.4104	0.4644	0.4118	0.4703	0.4132
0.4575	0.4182	0.4636	0.4197	0.4697	0.4211	0.4758	0.4225
H13		H23		H33		H43	
CIE X	CIE Y	CIE X	CIE Y	CIE X	CIE Y	CIE X	CIE Y
0.4468	0.4077	0.4526	0.4090	0.4585	0.4104	0.4644	0.4118
0.4420	0.3985	0.4477	0.3998	0.4534	0.4012	0.4591	0.4025
0.4477	0.3998	0.4534	0.4012	0.4591	0.4025	0.4648	0.4038
0.4526	0.4090	0.4585	0.4104	0.4644	0.4118	0.4703	0.4132
H14		H24		H34		H44	
CIE X	CIE Y	CIE X	CIE Y	CIE X	CIE Y	CIE X	CIE Y
0.4420	0.3985	0.4477	0.3998	0.4534	0.4012	0.4591	0.4025
0.4373	0.3893	0.4428	0.3906	0.4483	0.3919	0.4538	0.3932
0.4428	0.3906	0.4483	0.3919	0.4538	0.3932	0.4593	0.3944
0.4477	0.3998	0.4534	0.4012	0.4591	0.4025	0.4648	0.4038

## Mechanical Dimensions

Top View

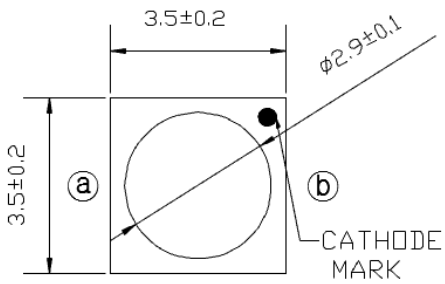

Bottom View

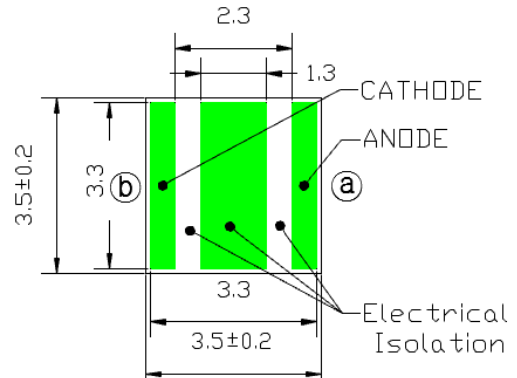

Side View

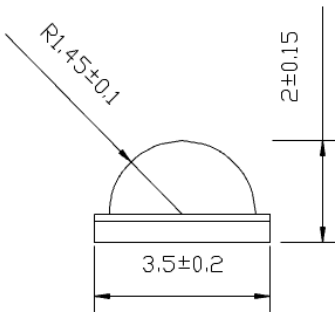

Circuit

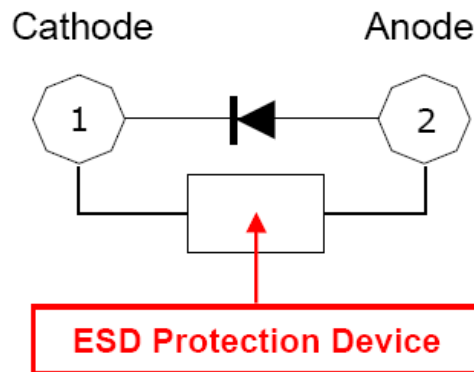

- (1) All dimensions are in millimeters.
- (2) Scale : none
- (3) Undefined tolerance is  $\pm 0.1\text{mm}$





## Reflow Soldering Characteristics

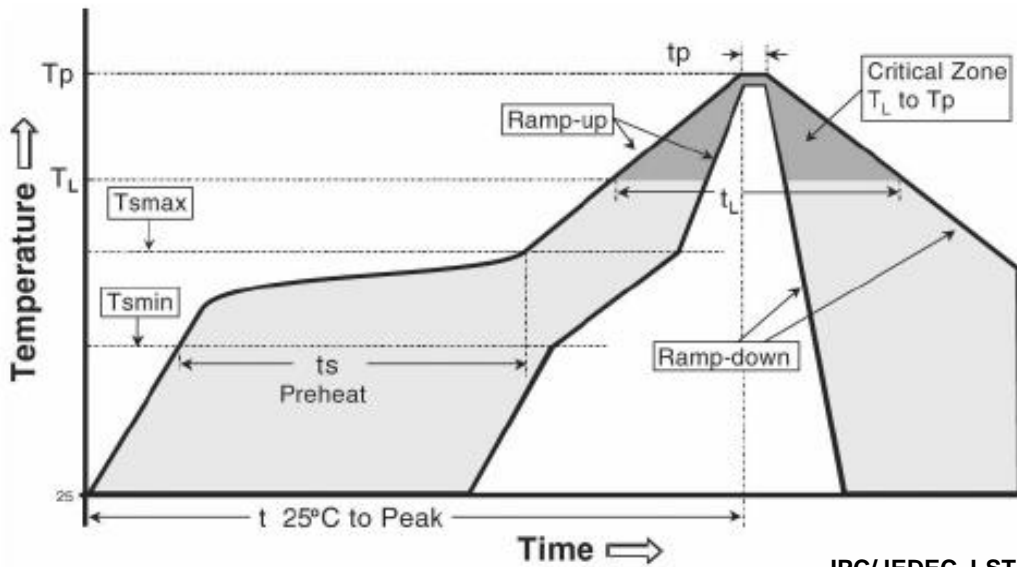

**IPC/JEDEC J-STD-020**

Profile Feature	Sn-Pb Eutectic Assembly	Pb-Free Assembly
Average ramp-up rate (T <sub>smax</sub> to T <sub>p</sub> )	3° C/second max.	3° C/second max.
Preheat - Temperature Min (T <sub>smin</sub> ) - Temperature Max (T <sub>smax</sub> ) - Time (T <sub>smin</sub> to T <sub>smax</sub> ) (t <sub>s</sub> )	100 °C 150 °C 60-120 seconds	150 °C 200 °C 60-180 seconds
Time maintained above: - Temperature (T <sub>L</sub> ) - Time (t <sub>L</sub> )	183 °C 60-150 seconds	217 °C 60-150 seconds
Peak Temperature (T <sub>p</sub> )	215 °C	260 °C
Time within 5°C of actual Peak Temperature (t <sub>p</sub> ) <sup>2</sup>	10-30 seconds	20-40 seconds
Ramp-down Rate	6 °C/second max.	6 °C/second max.
Time 25°C to Peak Temperature	6 minutes max.	8 minutes max.

### Caution

- (1) Reflow soldering is recommended not to be done more than two times. In the case of more than 24 hours passed soldering after first, LEDs will be damaged.
- (2) Repairs should not be done after the LEDs have been soldered. When repair is unavoidable, suitable tools must be used.
- (3) Die slug is to be soldered.
- (4) When soldering, do not put stress on the LEDs during heating.
- (5) After soldering, do not warp the circuit board.

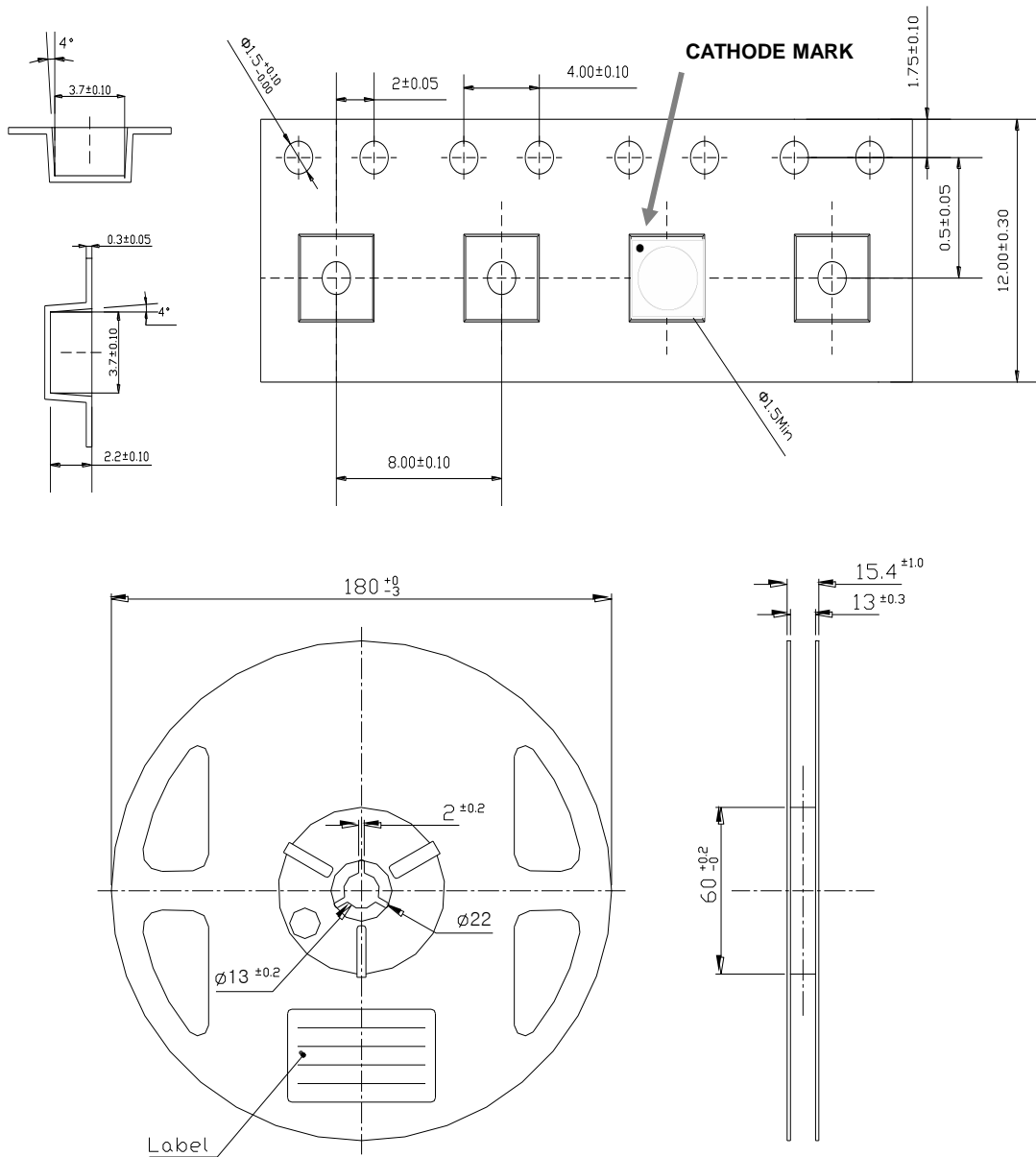
# Emitter Tape & Reel Packaging

**Notes :**

1. Quantity : 1000pcs/Reel
2. Cumulative Tolerance : Cumulative Tolerance/10 pitches to be  $\pm 0.2\text{mm}$
3. Adhesion Strength of Cover Tape : Adhesion strength to be 10-60g when the cover tape is turned off from the carrier tape at the angle of  $10^\circ$  to the carrier tape
4. Package : P/N, Manufacturing data Code No. and quantity to be indicated on a damp proof Package

## Packaging Information

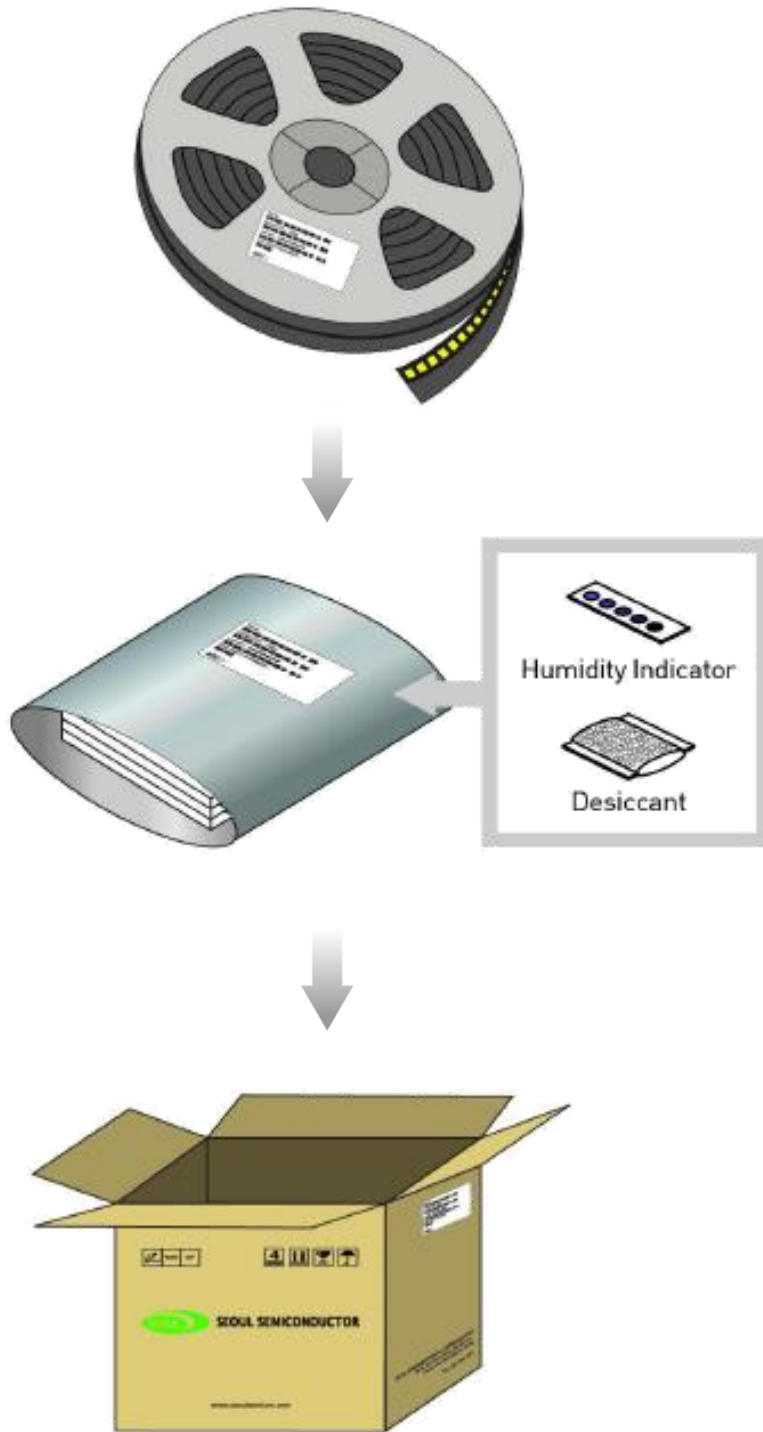

## Product Nomenclature

**Table 6. Part Numbering System : X<sub>1</sub>X<sub>2</sub>X<sub>3</sub> - X<sub>4</sub>X<sub>5</sub> - X<sub>6</sub>X<sub>7</sub> - X<sub>8</sub>X<sub>9</sub>**

Part Number Code	Description	Part Number	Value
X <sub>1</sub>	Company	S	-
X <sub>2</sub>	Z-Power LED series number	Z	-
X <sub>3</sub>	PKG series	5	-
X <sub>4</sub>	PKG series	M	M series
X <sub>5</sub>	Revision number	2	New version
X <sub>6</sub> X <sub>7</sub>	Color Specification	W0	Pure white
		WN	Neutral white
		WW	Warm white
X <sub>8</sub> X <sub>9</sub>	Color Specification	C8	CRI (min.) 80
		C9	CRI (min.) 90
		00	The others

**Table 7. Lot Numbering System : Y<sub>1</sub>Y<sub>1</sub>Y<sub>2</sub>Y<sub>3</sub>Y<sub>4</sub>Y<sub>5</sub>Y<sub>5</sub>Y<sub>5</sub> - Y<sub>6</sub>Y<sub>6</sub>Y<sub>6</sub> - Y<sub>7</sub>Y<sub>7</sub>Y<sub>7</sub> - Y<sub>8</sub>Y<sub>8</sub>Y<sub>8</sub>Y<sub>8</sub>Y<sub>8</sub>**

Lot Number Code	Description
Y <sub>1</sub>	Year
Y <sub>2</sub>	Month
Y <sub>3</sub>	Day
Y <sub>4</sub>	Production area
Y <sub>5</sub>	Mass order
Y <sub>6</sub>	Taping number
Y <sub>7</sub>	Reel number
Y <sub>8</sub>	Internal management number

## Handling of Silicone Resin for LEDs

- (1) During processing, mechanical stress on the surface should be minimized as much as possible. Sharp objects of all types should not be used to pierce the sealing compound.

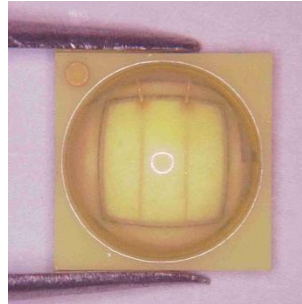

- (2) In general, LEDs should only be handled from the side. By the way, this also applies to LEDs without a silicone sealant, since the surface can also become scratched.
- (3) When populating boards in SMT production, there are basically no restrictions regarding the form of the pick and place nozzle, except that mechanical pressure on the surface of the resin must be prevented. This is assured by choosing a pick and place nozzle which is larger than the LED's reflector area.
- (4) Silicone differs from materials conventionally used for the manufacturing of LEDs. These conditions must be considered during the handling of such devices. Compared to standard encapsulants, silicone is generally softer, and the surface is more likely to attract dust. As mentioned previously, the increased sensitivity to dust requires special care during processing. In cases where a minimal level of dirt and dust particles cannot be guaranteed, a suitable cleaning solution must be applied to the surface after the soldering of components.
- (5) Seoul Semiconductor suggests using isopropyl alcohol for cleaning. In case other solvents are used, it must be assured that these solvents do not dissolve the package or resin. Ultrasonic cleaning is not recommended. Ultrasonic cleaning may cause damage to the LED.
- (6) Please do not mold this product into another resin (epoxy, urethane, etc) and do not handle this product with acid or sulfur material in sealed space.
- (7) Avoid leaving fingerprints on silicone resin parts.

## Precaution for Use

### (1) Storage

To avoid the moisture penetration, we recommend storing Z5 Series LEDs in a dry box with a desiccant. The recommended storage temperature range is 5 °C to 30 °C and a maximum humidity of RH50%.

### (2) Use Precaution after Opening the Packaging

Use proper SMD techniques when the LED is to be soldered dipped as separation of the lens may affect the light output efficiency.

Pay attention to the following:

a. Recommend conditions after opening the package

- Sealing / Temperature : 5 ~ 30 °C Humidity : less than RH60%

b. If the package has been opened more than 1 year (MSL 2) or the color of

the desiccant changes, components should be dried for 10-24hr at 65±5 °C

(3) Do not apply mechanical force or excess vibration during the cooling process to normal temperature after soldering.

(4) Do not rapidly cool device after soldering.

(5) Components should not be mounted on warped (non coplanar) portion of PCB.

(6) Radioactive exposure is not considered for the products listed here in.

(7) Gallium arsenide is used in some of the products listed in this publication. These products are dangerous if they are burned or shredded in the process of disposal. It is also dangerous to drink the liquid or inhale the gas generated by such products when chemically disposed of.

(8) This device should not be used in any type of fluid such as water, oil, organic solvent and etc. When washing is required, IPA (Isopropyl Alcohol) should be used.

(9) When the LEDs are in operation the maximum current should be decided after measuring the package temperature.

(10) The appearance and specifications of the product may be modified for improvement without notice.

(11) Long time exposure of sunlight or occasional UV exposure will cause lens discoloration.

## Precaution for Use

(12) VOCs (Volatile organic compounds) emitted from materials used in the construction of fixtures can penetrate silicone encapsulants of LEDs and discolor when exposed to heat and photonic energy. The result can be a significant loss of light output from the fixture. Knowledge of the properties of the materials selected to be used in the construction of fixtures can help prevent these issues.

(13) The slug is electrically isolated.

(14) Attaching LEDs, do not use adhesives that outgas organic vapor.

(15) The driving circuit must be designed to allow forward voltage only when it is ON or OFF. If the reverse voltage is applied to LED, migration can be generated resulting in LED damage.

(16) LEDs are sensitive to Electro-Static Discharge (ESD) and Electrical Over Stress (EOS). Below is a list of suggestions that Seoul Semiconductor purposes to minimize these effects.

### a. ESD (Electro Static Discharge)

Electrostatic discharge (ESD) is defined as the release of static electricity when two objects come into contact. While most ESD events are considered harmless, it can be an expensive problem in many industrial environments during production and storage. The damage from ESD to LEDs may cause the product to demonstrate unusual characteristics such as:

- Increase in reverse leakage current lowered turn-on voltage
- Abnormal emissions from the LED at low current

The following recommendations are suggested to help minimize the potential for an ESD event. One or more recommended work area suggestions:

- Ionizing fan setup
- ESD table/shelf mat made of conductive materials
- ESD safe storage containers

One or more personnel suggestion options:

- Antistatic wrist-strap
- Antistatic material shoes
- Antistatic clothes

Environmental controls:

- Humidity control (ESD gets worse in a dry environment)

## Precaution for Use

### b. EOS (Electrical Over Stress)

Electrical Over-Stress (EOS) is defined as damage that may occur when an electronic device is subjected to a current or voltage that is beyond the maximum specification limits of the device. The effects from an EOS event can be noticed through product performance like:

- Changes to the performance of the LED package  
(If the damage is around the bond pad area and since the package is completely encapsulated the package may turn on but flicker show severe performance degradation.)
- Changes to the light output of the luminaire from component failure
- Components on the board not operating at determined drive power

Failure of performance from entire fixture due to changes in circuit voltage and current across total circuit causing trickle down failures. It is impossible to predict the failure mode of every LED exposed to electrical overstress as the failure modes have been investigated to vary, but there are some common signs that will indicate an EOS event has occurred:

- Damaged may be noticed to the bond wires (appearing similar to a blown fuse)
- Damage to the bond pads located on the emission surface of the LED package  
(shadowing can be noticed around the bond pads while viewing through a microscope)
- Anomalies noticed in the encapsulation and phosphor around the bond wires.
- This damage usually appears due to the thermal stress produced during the EOS event.

### c. To help minimize the damage from an EOS event Seoul Semiconductor recommends utilizing:

- A surge protection circuit
- An appropriately rated over voltage protection device
- A current limiting device





## Company Information

### Published by

Seoul Semiconductor © 2013 All Rights Reserved.

### Company Information

Seoul Semiconductor ([www.SeoulSemicon.com](http://www.SeoulSemicon.com)) manufactures and packages a wide selection of light emitting diodes (LEDs) for the automotive, general illumination/lighting, Home appliance, signage and back lighting markets. The company is the world's fifth largest LED supplier, holding more than 10,000 patents globally, while offering a wide range of LED technology and production capacity in areas such as "nPola", "Acrich", the world's first commercially produced AC LED, and "Acrich MJT - Multi-Junction Technology" a proprietary family of high-voltage LEDs.

The company's broad product portfolio includes a wide array of package and device choices such as Acrich and Acirch2, high-brightness LEDs, mid-power LEDs, side-view LEDs, and through-hole type LEDs as well as custom modules, displays, and sensors.

### Legal Disclaimer

Information in this document is provided in connection with Seoul Semiconductor products. With respect to any examples or hints given herein, any typical values stated herein and/or any information regarding the application of the device, Seoul Semiconductor hereby disclaims any and all warranties and liabilities of any kind, including without limitation, warranties of non-infringement of intellectual property rights of any third party. The appearance and specifications of the product can be changed to improve the quality and/or performance without notice.

## X-ON Electronics

Largest Supplier of Electrical and Electronic Components

*Click to view similar products for [High Power LEDs - White category:](#)*

*Click to view products by [Seoul Semiconductor manufacturer:](#)*

Other Similar products are found below :

[LTW-K140SZR40](#) [B42180-08](#) [STW8Q2PA-R5-HA](#) [LTPL-P00DWS57](#) [LTW-K140SZR30](#) [LZP-D0WW00-0000](#) [SZ5-M1-WW-C8-V1/V3-FA](#) [LTW-K140SZR57](#) [LTW-K140SZR27](#) [BXRE-50C2001-C-74](#) [MP-5050-8100-27-80](#) [MP-5050-6100-65-80](#) [MP-5050-6100-50-80](#) [MP-5050-6100-40-80](#) [MP-5050-6100-30-80](#) [KW DPLS32.SB-6H6J-E5P7-EG-Z264](#) [L1V1-507003V500000](#) [KW CULPM1.TG-Z6RF7-ebvFfcbB46-65G5](#) [KW DMLS33.SG-Z6M7-EBVFFCBB46-8E8G-700-S](#) [GW PSLT33.PM-LYL3-XX56-1-G3](#) [ASMT-MW05-NMNS1](#) [KW DPLS33.KD-HIJG-D30D144-HN-22C2-120-S](#) [KW DDLM31.EH-5J6K-A737-W4A4-140-R18](#) [GW JTLRS1.CM-K1LW-XX57-1-100-Q-R33](#) [KW DDLM31.EH-5J6K-A636-W4A4-140-R18](#) [KW DDLM31.EH-5J6K-A131-W4A4-140-R18](#) [GW PSLT33.PM-LYL3-XX57-1-G3](#) [SML-LXL8047MWCTR/3](#) [L2C5-40HG1203E0900](#) [JB3030AWT-P-U27EA0000-N0000001](#) [JK3030AWT-P-U30EA0000-N0000001](#) [JK3030AWT-P-B40EB0000-N0000001](#) [JK3030AWT-P-H30EB0000-N0000001](#) [JK3030AWT-P-H40EB0000-N0000001](#) [JK3030AWT-P-U27EB0000-N0000001](#) [JK3030AWT-P-U30EB0000-N0000001](#) [XPGBWT-HE-0000-00JE5](#) [GW CSSRM2.PM-N3N5-XX53-1](#) [GW P9LMS1.EM-NRNU-30S7-0-200-R18](#) [GW PSLPS1.EC-KSKU-5R8T-1](#) [LTPL-M03614ZS50-F1](#) [LTW-2835SZK65](#) [LTW-3030AQL40](#) [LTW-3030AZL40-EU](#) [LTW-3030BSL42](#) [LTW-3030DZL30](#) [LTW-3030SZK40](#) [LTW-3030SZK65](#) [LTW-5630AQL27](#) [LTW-5630AQL30](#)