

High Power Pure White LED

**Z Power LED – W42180-08**

**P4 White Color LED**



## Product Brief

### Description

- Z-Power series is designed for high current operation and high flux output applications.
- Z-Power LED's thermal management perform exceeds other power LED solutions.
- It incorporates state of the art SMD design and Thermal emission material.
- Z Power LED is ideal light sources for general illumination applications, custom designed solutions, automotive large LCD backlights
- This application note provides binning and labeling information of Z-Power LED series.
- It includes the Z-Power LED bins for luminous flux, wavelength (or x,y coordinates), correlated color temperature (CCT) for white and forward voltage.

### Features and Benefits

- Super high flux output and high luminance
- Designed for high current operation
- Low thermal resistance
- SMT solderability
- Lead free product
- RoHS compliant

### Key Applications

- Mobile phone flash
- Automotive interior / Exterior lighting
- Automotive signal lighting
- Automotive forward lighting
- Torch
- Architectural lighting
- LCD TV / Monitor backlight
- Projector light source
- Traffic signals
- Task lighting
- Decorative / Pathway lighting
- Remote / Solar powered lighting
- Household appliances

# Table of Contents

<b>Index</b>	
• Product Brief	1
• Table of Contents	2
• Performance Characteristics	3
• Characteristics Graph	5
• Color Bin Structure	11
• Mechanical Dimensions	14
• Reflow Soldering Characteristics	15
• Emitter Tape & Reel Packing	16
• Packaging Information	17
• Product Nomenclature	18
• Handling of Silicone Resin for LEDs	19
• Precaution For Use	20
• Company Information	21

---

## Performance Characteristics

**Table 1. Electro-Optical characteristics,  $I_F=350\text{mA}$ ,  $T_a=25^\circ\text{C}$ , RH30%**

Parameter	Symbol	Value			Unit
		Min	Typ.	Max	
Luminous Flux <sup>[1]</sup>	$\Phi_V$ <sup>[2]</sup>	-	110	-	lm
	$\Phi_V (T_j=100^\circ\text{C})$	-	94	-	
Correlated Color Temperature <sup>[3]</sup>	CCT	-	6000	-	K
CRI	$R_a$	-	70	-	-
Forward Voltage <sup>[4]</sup>	$V_F$	-	3.3	-	V
Thermal resistance (J to S)	$R\theta_{J-S}$		6.2		K/W
View Angle	$2\theta_{1/2}$		123		deg.

**Notes :**

[1] SSC maintains a tolerance of  $\pm 10\%$  on flux and power measurements.

[2]  $\Phi_V$  is the total luminous flux output as measured with an integrating sphere.

[3] Correlated Color Temperature is derived from the CIE 1931 Chromaticity diagram.

Color coordinate : 0.005, CCT  $\pm 5\%$  tolerance.

[4] Tolerance is  $\pm 0.06\text{V}$  on forward voltage measurements

## Performance Characteristics

**Table 2. Absolute Maximum Ratings**

Parameter	Symbol	Value	Unit
Forward Current	$I_F$	1000	mA
		1500(1/10duty@1kHz)	
Reverse Voltage	$V_R$	5	V
Power Dissipation	$P_d$	4	W
Junction Temperature	$T_j$	145(@ $I_F \leq 1000\text{mA}$ )	°C
Operating Temperature	$T_{opr}$	-40 ~ +85	°C
Storage Temperature	$T_{stg}$	-40 ~ +100	°C
ESD Sensitivity [5]	-	±8,000V HBM	-

**Notes :**

[5] A zener diode is included to protect the product from ESD.

## Characteristics Graph

Fig 1. Color Spectrum,  $T_j=25^\circ\text{C}$ ,  $I_F=350\text{mA}$ , RH30%

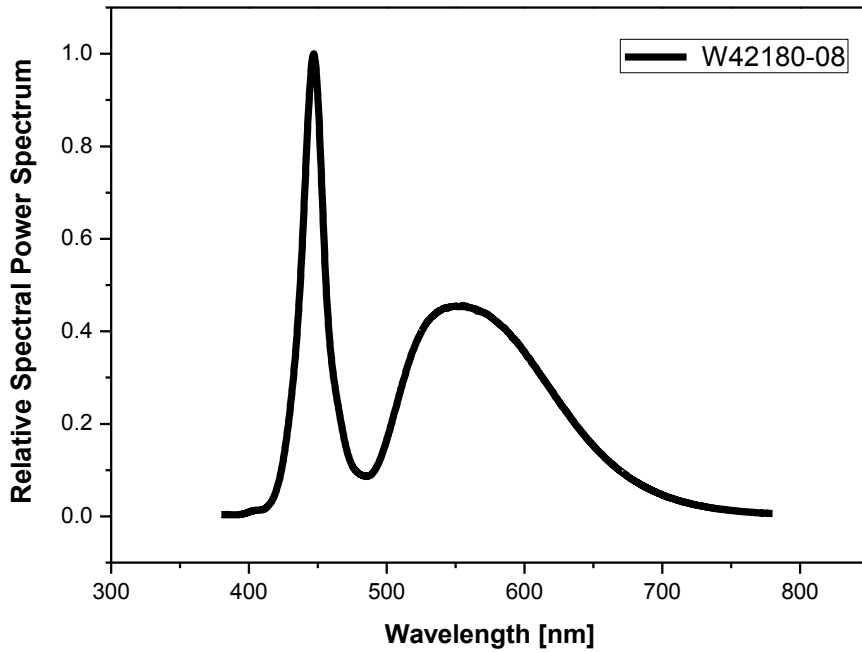
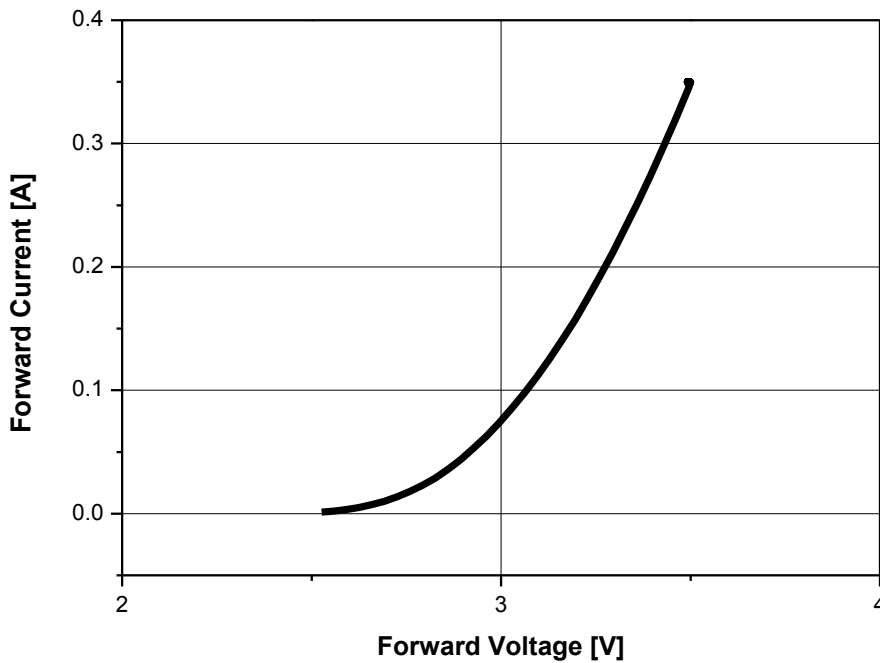

Fig 2. Forward Voltage vs. Forward Current,  $T_a=25^\circ\text{C}$



## Characteristics Graph

Fig 3. Forward Current vs. Normalized Relative Luminous Flux, Ta=25°C.

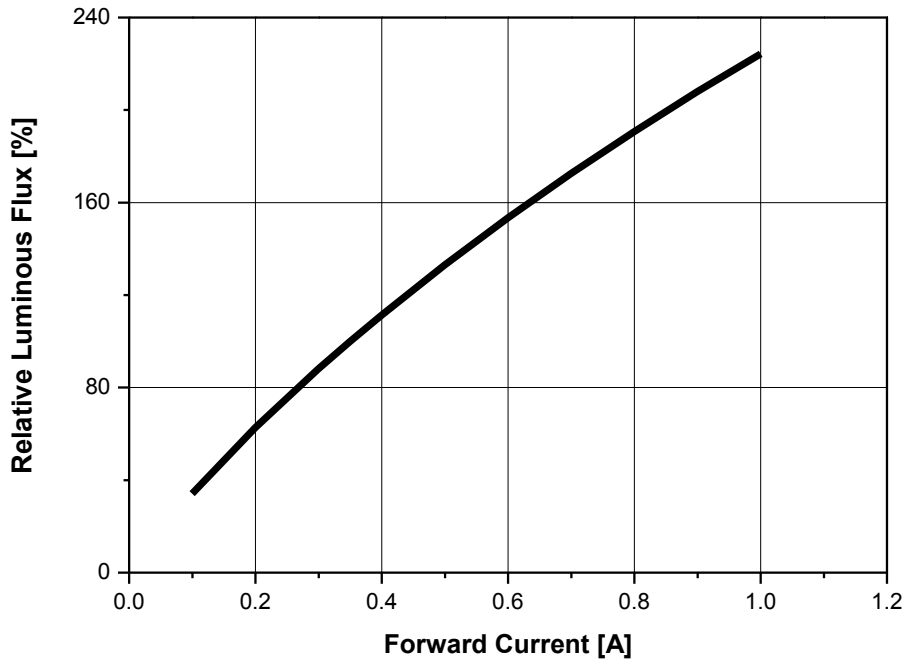
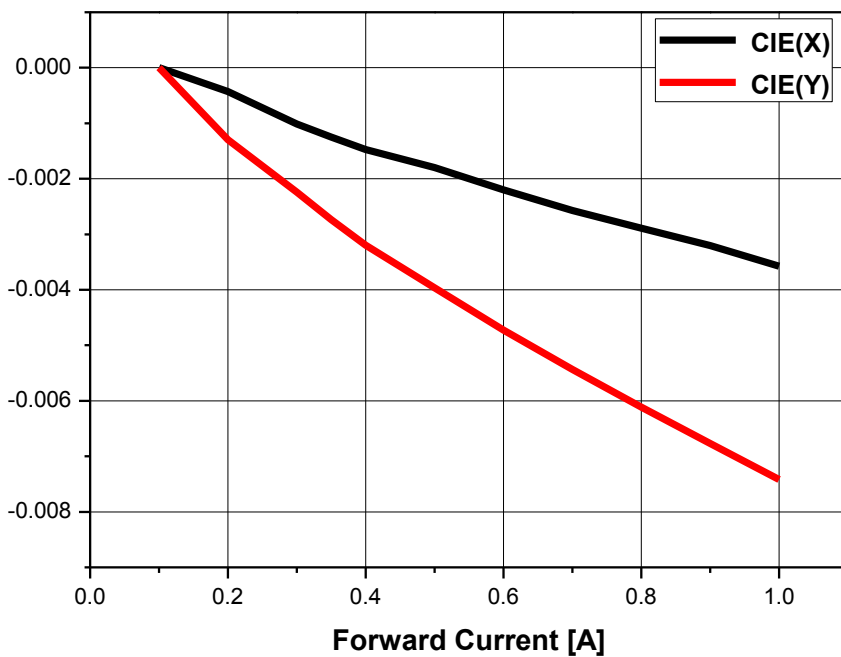
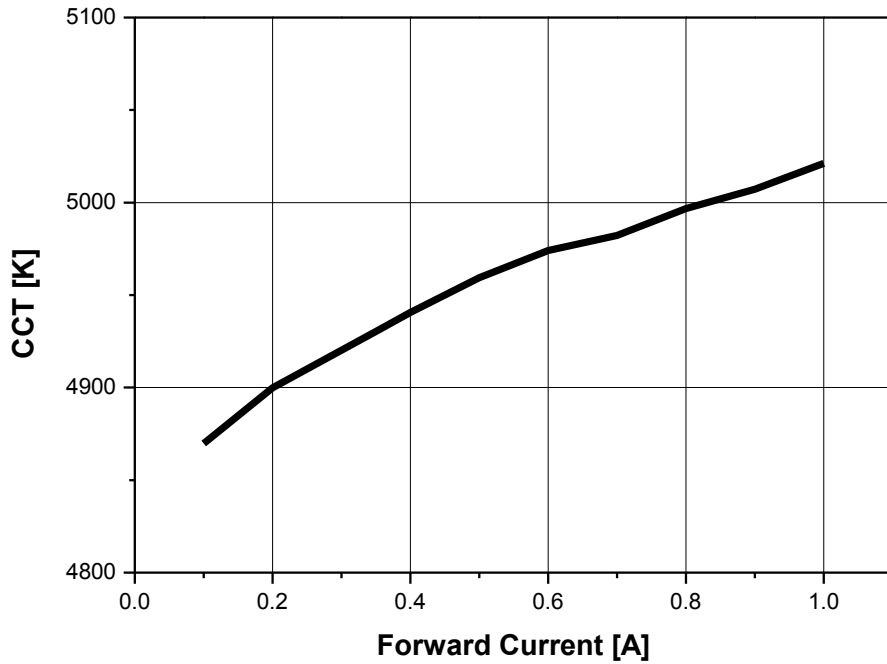

Fig 4. Forward Current vs. Chromaticity Coordinate, Ta=25°C



## Characteristics Graph

**Fig 5. Forward Current vs. CCT, Ta=25°C**



**Fig 6. Junction Temperature vs. Relative Light Output , IF=350mA**

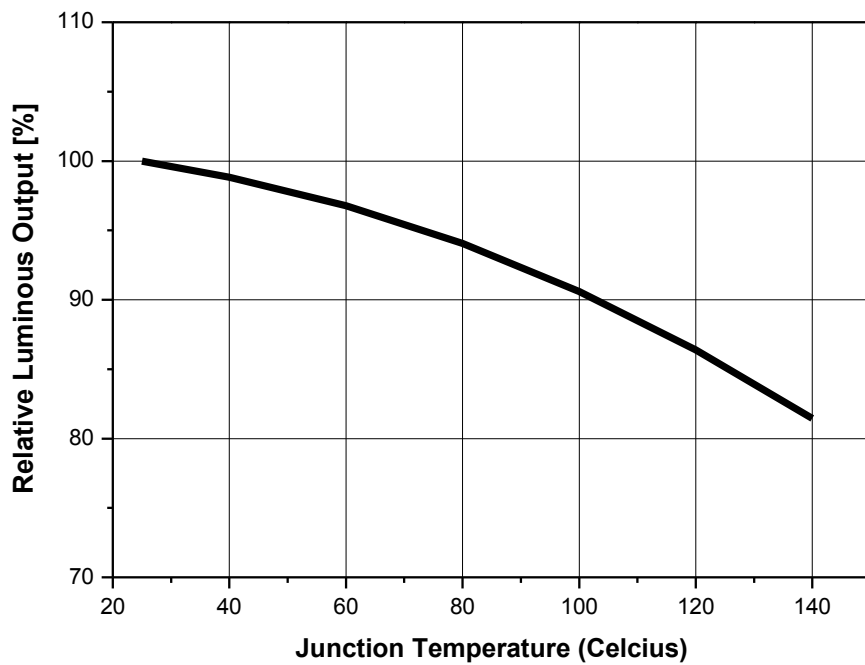

## Characteristics Graph

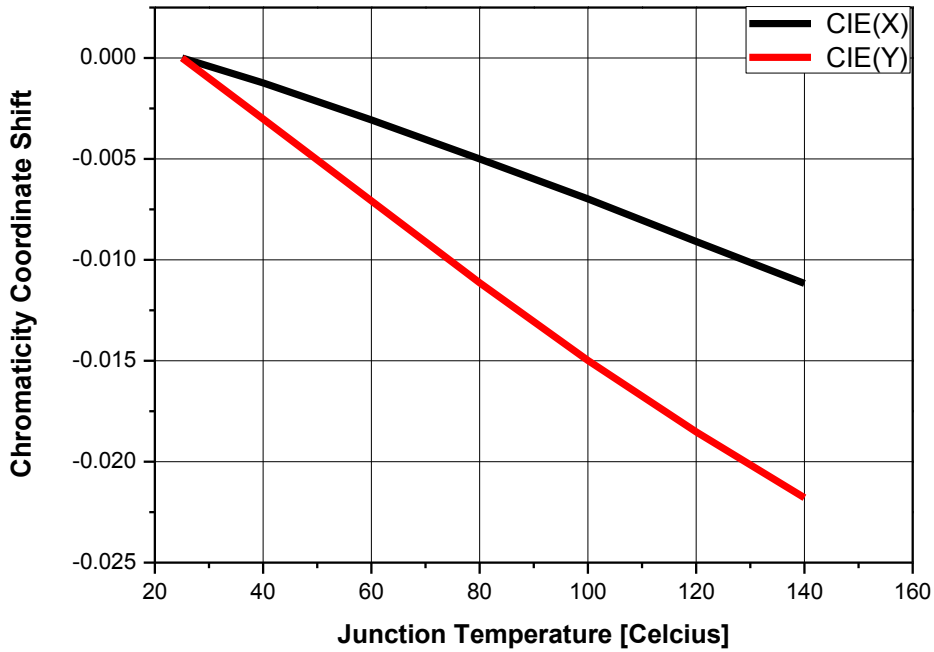
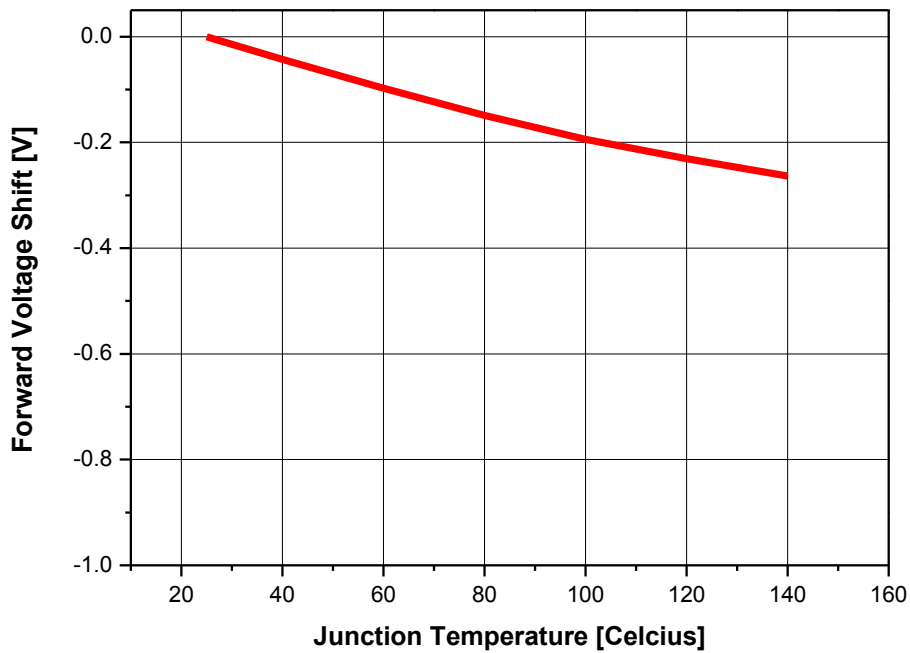
**Fig 7. Junction Temperature vs. Chromaticity Coordinate , IF=350mA**

**Fig 8. Junction Temperature vs. Forward Voltage, IF=350mA**



## Characteristics Graph

Fig 9. Junction Temperature vs. CCT, IF=350mA

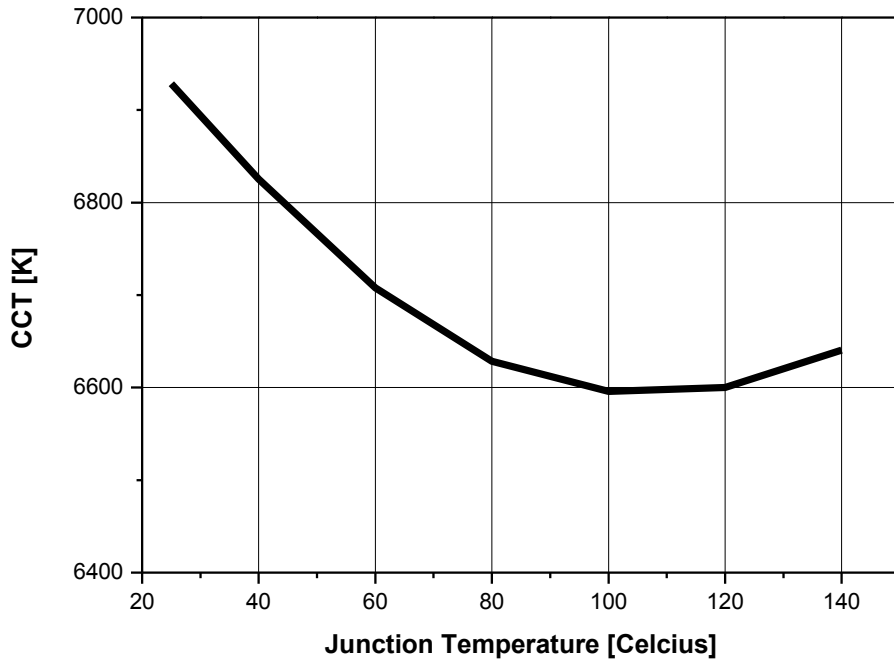
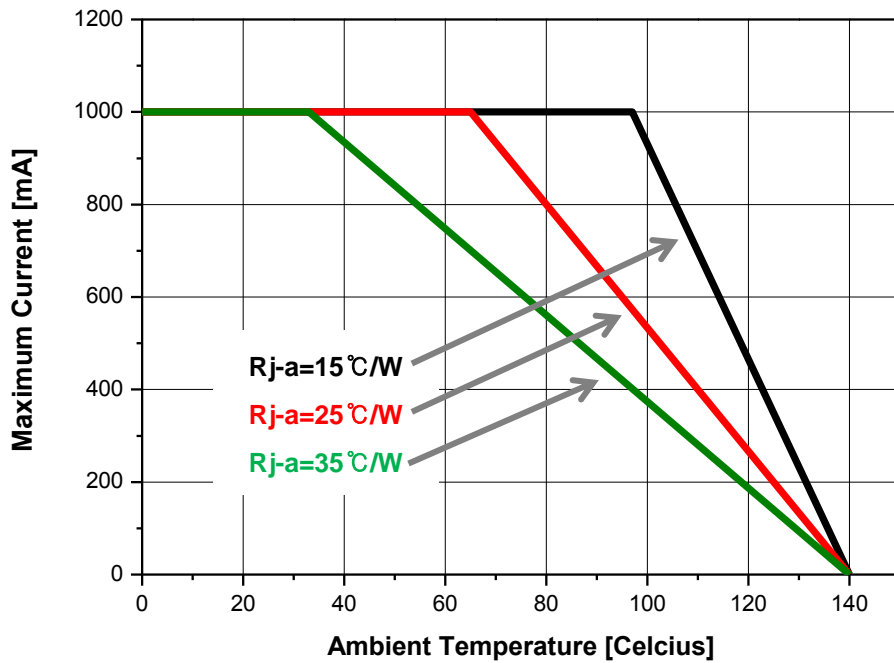
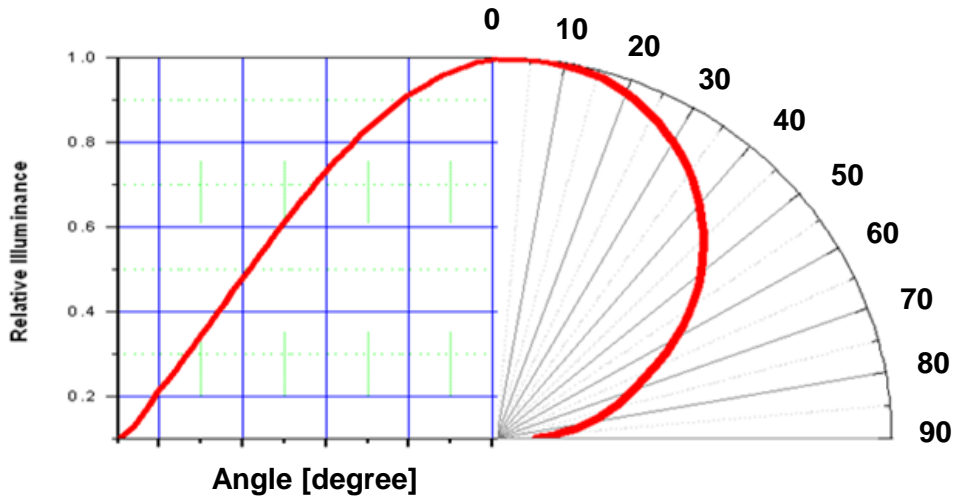

Fig 10. Ambient Temperature vs. Allowable Forward Current ( $T_j \text{ max} = 145^\circ\text{C}$ , @1A)



## Characteristics Graph

Fig 11. Radiation pattern at 350mA



## Color Bin Structure

**Table 3. Bin Code description,  $I_F = 350\text{mA}$ ,  $T_a = 25^\circ\text{C}$** 

Part Number	Luminous Flux (lm) <sup>(1)</sup>			CIE Coordinate	Forward Voltage (V)		
	Bin Code	Min.	Max.		Bin Code	Min.	Max.
W42180-08	V1	118.5	130.0	A0 ~ A9	H	3.00	3.25
	V2	130.0	140.0	B0 ~ B6	I	3.25	3.50
	V3	140.0	154.0	C0 ~ C5	J	3.50	3.75

(1) Tolerance is  $\pm 0.06\text{V}$  on forward voltage measurements.

## Color Bin Structure

CIE Chromaticity Diagram,  $T_j=25^\circ\text{C}$ ,  $I_f=350\text{mA}$

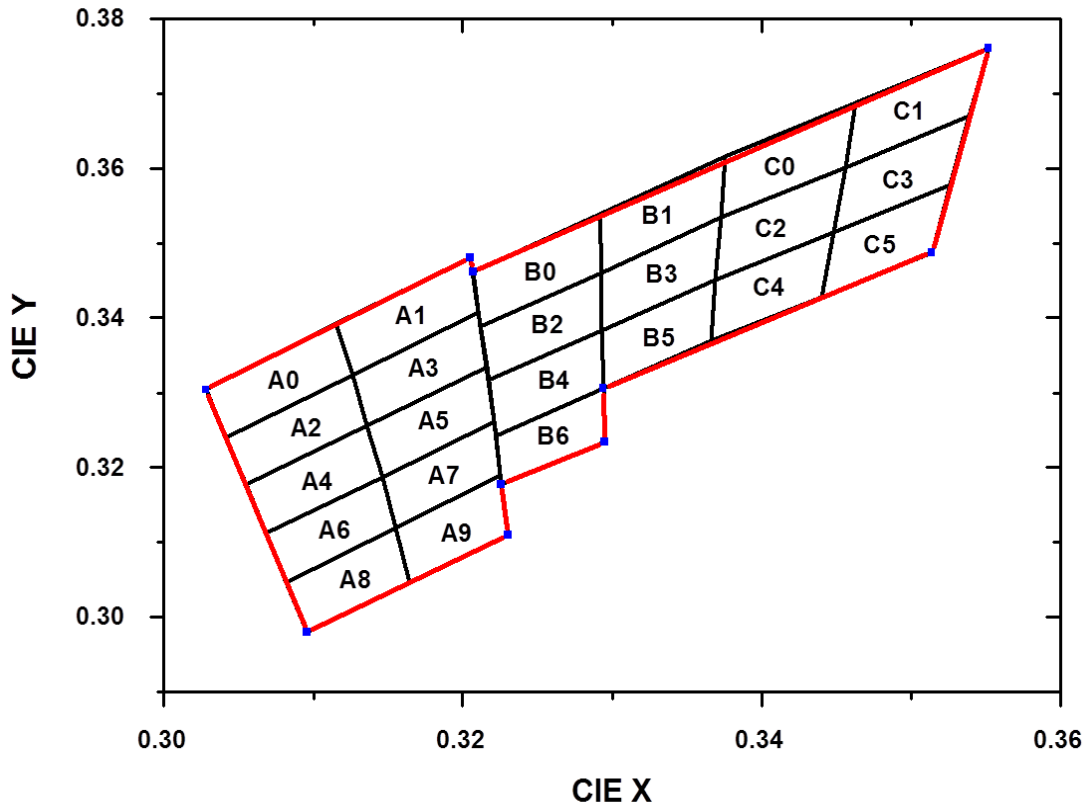

**\*Notes :**

- Measurement Uncertainty of the Color Coordinates :  $\pm 0.007$

## Color Bin Structure

**CIE Chromaticity Diagram,  $T_j=25^\circ\text{C}$ ,  $I_f=350\text{mA}$** 

	CIE x	CIE y		CIE x	CIE y		CIE x	CIE y
A0	0.3028	0.3304	B0	0.3207	0.3462	C0	0.3376	0.3616
	0.3041	0.3240		0.3212	0.3389		0.3373	0.3534
	0.3126	0.3324		0.3293	0.3461		0.3456	0.3601
	0.3115	0.3393		0.3292	0.3539		0.3463	0.3687
	0.3028	0.3304		0.3207	0.3462		0.3376	0.3616
A1	0.3115	0.3393	B1	0.3292	0.3539	C1	0.3463	0.3687
	0.3126	0.3324		0.3293	0.3461		0.3456	0.3601
	0.3210	0.3408		0.3373	0.3534		0.3539	0.3669
	0.3205	0.3481		0.3376	0.3616		0.3552	0.3760
	0.3115	0.3393		0.3292	0.3539		0.3463	0.3687
A2	0.3041	0.3240	B2	0.3212	0.3389	C2	0.3373	0.3534
	0.3055	0.3177		0.3217	0.3316		0.3369	0.3451
	0.3136	0.3256		0.3293	0.3384		0.3448	0.3514
	0.3126	0.3324		0.3293	0.3461		0.3456	0.3601
	0.3041	0.3240		0.3212	0.3389		0.3373	0.3534
A3	0.3126	0.3324	B3	0.3293	0.3461	C3	0.3456	0.3601
	0.3136	0.3256		0.3293	0.3384		0.3448	0.3514
	0.3216	0.3334		0.3369	0.3451		0.3526	0.3578
	0.3210	0.3408		0.3373	0.3534		0.3539	0.3669
	0.3126	0.3324		0.3293	0.3461		0.3456	0.3601
A4	0.3055	0.3177	B4	0.3217	0.3316	C4	0.3369	0.3451
	0.3068	0.3113		0.3222	0.3243		0.3366	0.3369
	0.3146	0.3187		0.3294	0.3306		0.3440	0.3428
	0.3136	0.3256		0.3293	0.3384		0.3448	0.3514
	0.3055	0.3177		0.3217	0.3316		0.3369	0.3451
A5	0.3136	0.3256	B5	0.3293	0.3384	C5	0.3448	0.3514
	0.3146	0.3187		0.3294	0.3306		0.3440	0.3428
	0.3221	0.3261		0.3366	0.3369		0.3514	0.3487
	0.3216	0.3334		0.3369	0.3451		0.3526	0.3578
	0.3136	0.3256		0.3293	0.3384		0.3448	0.3514
A6	0.3068	0.3113	B6	0.3222	0.3243			
	0.3082	0.3046		0.3226	0.3178			
	0.3155	0.3120		0.3295	0.3234			
	0.3146	0.3187		0.3294	0.3306			
	0.3068	0.3113		0.3222	0.3243			
A7	0.3146	0.3187						
	0.3155	0.3120						
	0.3225	0.3190						
	0.3221	0.3261						
	0.3146	0.3187						
A8	0.3082	0.3046						
	0.3096	0.2980						
	0.3164	0.3046						
	0.3155	0.3120						
	0.3082	0.3046						
A9	0.3155	0.3120						
	0.3164	0.3046						
	0.3230	0.3110						
	0.3225	0.3190						
	0.3155	0.3120						

## Mechanical Dimensions

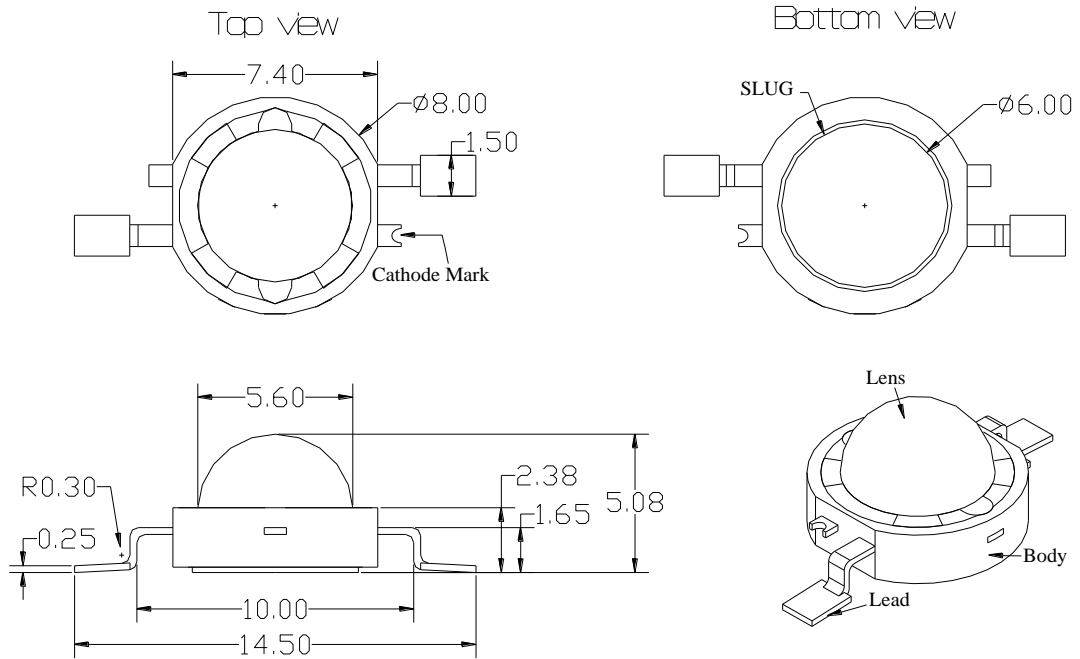
**Notes :**

1. All dimensions are in millimeters. (tolerance :  $\pm 0.2$  )
2. Scale : none
3. Slug of package is connected to anode.

\* The appearance and specifications of the product may be changed for improvement without notice.

## Reflow Soldering Characteristics

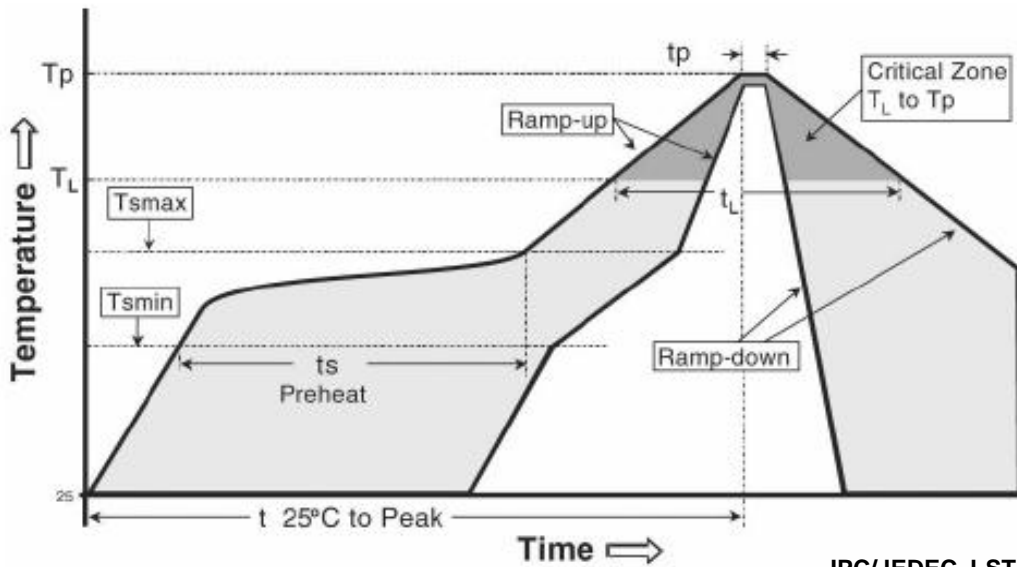

**IPC/JEDEC J-STD-020**

Profile Feature	Sn-Pb Eutectic Assembly	Pb-Free Assembly
Average ramp-up rate (T <sub>smax</sub> to T <sub>p</sub> )	3° C/second max.	3° C/second max.
Preheat - Temperature Min (T <sub>smin</sub> ) - Temperature Max (T <sub>smax</sub> ) - Time (T <sub>smin</sub> to T <sub>smax</sub> ) (t <sub>s</sub> )	100 °C 150 °C 60-120 seconds	150 °C 200 °C 60-180 seconds
Time maintained above: - Temperature (T <sub>L</sub> ) - Time (t <sub>L</sub> )	183 °C 60-150 seconds	217 °C 60-150 seconds
Peak Temperature (T <sub>p</sub> )	215 °C	260 °C
Time within 5°C of actual Peak Temperature (t <sub>p</sub> ) <sup>2</sup>	10-30 seconds	20-40 seconds
Ramp-down Rate	6 °C/second max.	6 °C/second max.
Time 25°C to Peak Temperature	6 minutes max.	8 minutes max.

### Caution

- (1) Reflow soldering is recommended not to be done more than two times. In the case of more than 24 hours passed soldering after first, LEDs will be damaged.
- (2) Repairs should not be done after the LEDs have been soldered. When repair is unavoidable, suitable tools must be used.
- (3) Die slug is to be soldered.
- (4) When soldering, do not put stress on the LEDs during heating.
- (5) After soldering, do not warp the circuit board.

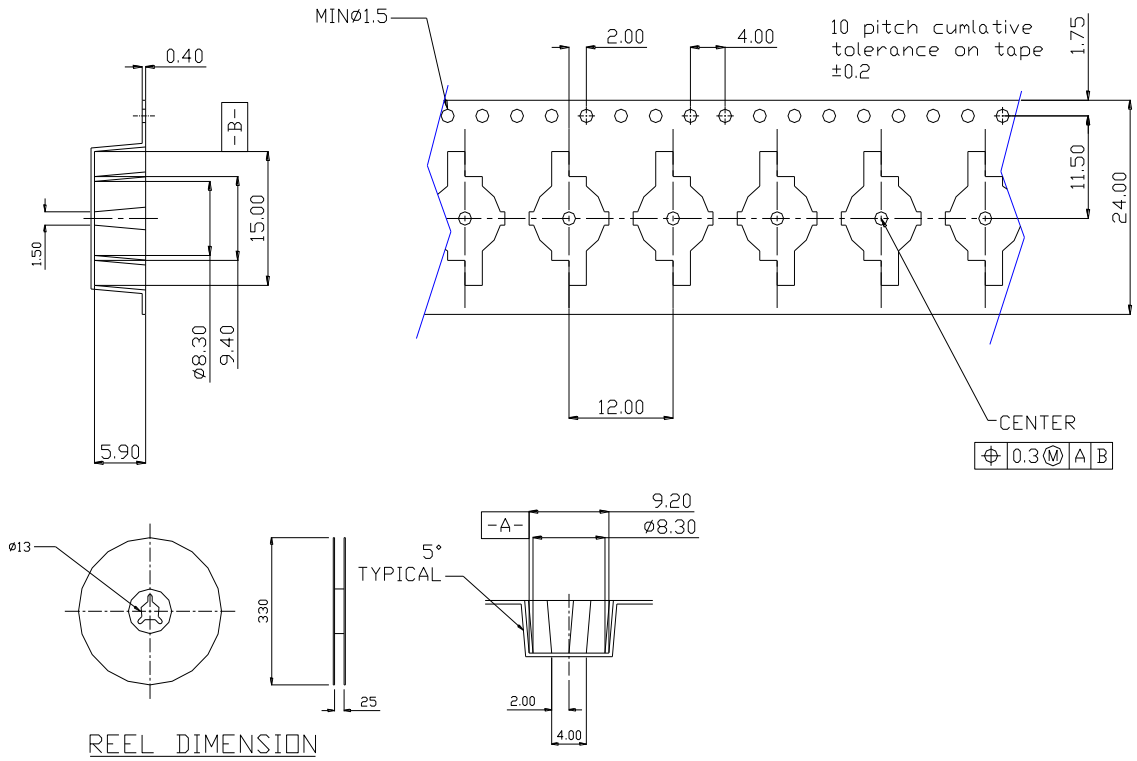
# Emitter Tape & Reel Packaging



**Notes :**

1. The number of loaded products in the reel is 500ea
2. All dimensions are in millimeters (tolerance :  $\pm 0.2$  )
3. Scale none

\*The appearance and specifications of the product may be changed for improvement without notice.

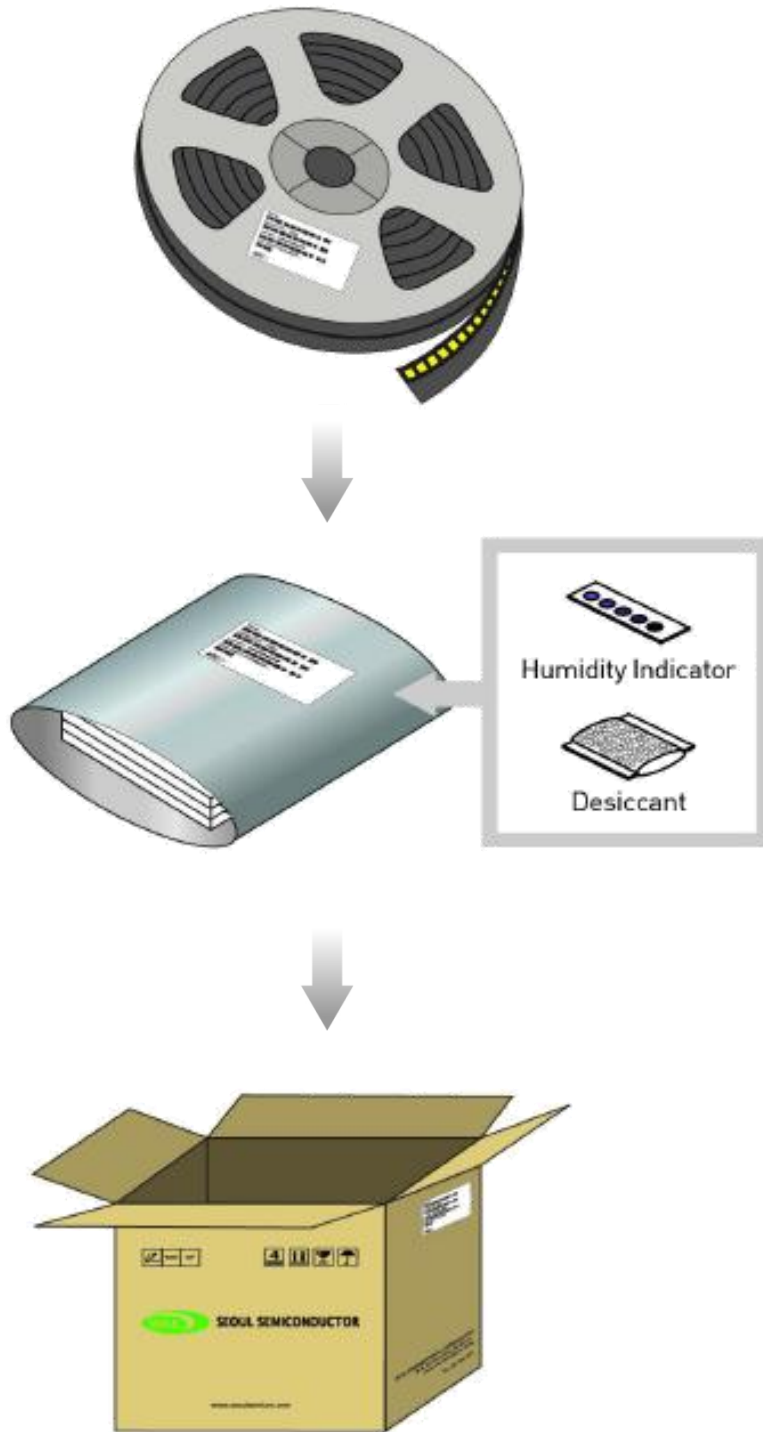

## Packaging Information

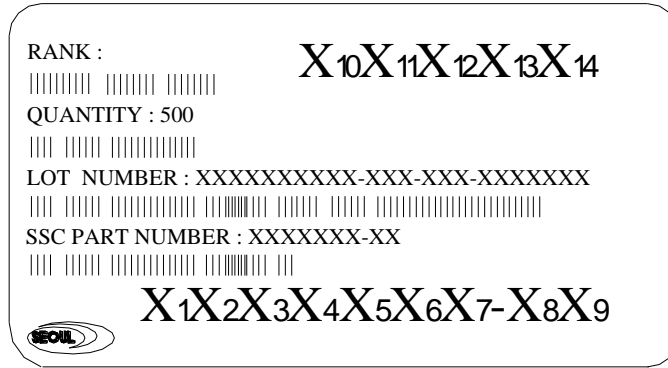

## Product Nomenclature

**Table 4. Full code form : X<sub>1</sub>X<sub>2</sub>X<sub>3</sub>X<sub>4</sub>X<sub>5</sub>X<sub>6</sub>-X<sub>7</sub>X<sub>8</sub>-X<sub>9</sub>X<sub>10</sub>X<sub>11</sub>X<sub>12</sub>X<sub>13</sub>X<sub>14</sub>**

Part Number Code	Description	Description
X <sub>1</sub>	Part Number	Color
X <sub>2</sub>		Z-Power LED Series
X <sub>3</sub>		Lens Type
X <sub>4</sub>		Chip quantity
X <sub>5</sub>		Package outline size
X <sub>6</sub>		PCB Type
X <sub>7</sub>		Grade of characteristic code
X <sub>8</sub>	Internal Number	Revision No.
X <sub>9</sub>		
X <sub>10</sub>	Code Labeling	Luminous flux
X <sub>11</sub>		X, Y coordinates rank code
X <sub>12</sub>		
X <sub>13</sub>		
X <sub>14</sub>	Forward voltage	

## Handling of Silicone Resin for LEDs

Z-Power LED is encapsulated by silicone resin for the highest flux efficiency.

Notes for handling of Silicone resin Z-Power LEDs

- Avoid touching silicone resin parts especially by sharp tools such as Pincette (Tweezers)
- Avoid leaving fingerprints on silicone resin parts.
- Dust sensitivity silicone resin need containers having cover for storage.
- When populating boards in SMT production, there are basically no restrictions regarding the form of the pick and place nozzle, except that mechanical pressure on the surface of the resin must be prevent.
- Please do not force over 2000 gf impact or pressure diagonally on the silicon lens.  
It will cause fatal damage of this product
- Please do not recommend to cover the silicone resin of the LEDs with other resin (epoxy, urethane, etc)
- Please do not mold this product into another resin (epoxy, urethane, etc) and do not handle this product with acid or sulfur material in sealed space.

## Precaution for Use

- Storage

To avoid the moisture penetration, we recommend storing Z Power LEDs in a dry box (or desiccator) with a desiccant. The recommended storage conditions are Temperature 5 to 30 degrees Centigrade. Humidity 50% maximum.

- Precaution after opening packaging

However LED is correspond SMD, when LED be soldered dip, interfacial separation may affect the light transmission efficiency, causing the light intensity to drop.

Attention in followed.

- a. Soldering should be done right after opening the package (within 24Hrs).

- b. Keeping of a fraction

- Sealing

- Temperature : 5 ~ 30℃ Humidity : less than 60%

- c. If the package has been opened more than 1week or the color of desiccant changes, components should be dried for 10-24hr at 65±5℃

- Any mechanical force or any excess vibration shall not be accepted to apply during cooling process to normal temp. after soldering.
- Please avoid rapid cooling after soldering.
- Components should not be mounted on warped direction of PCB.
- Anti radioactive ray design is not considered for the products listed here in.
- Gallium arsenide is used in some of the products listed in this publication. These products are dangerous if they are burned or shredded in the process of disposal. It is also dangerous to drink the liquid or inhale the gas generated by such products when chemically disposed.
- This device should not be used in any type of fluid such as water, oil, organic solvent and etc. When washing is required, IPA(Isopropyl Alcohol) should be used.
- When the LEDs are illuminating, operating current should be decided after considering the package maximum temperature.
- LEDs must be stored to maintain a clean atmosphere. If the LEDs are stored for 3 months or more after being shipped from SSC, a sealed container with a nitrogen atmosphere should be used for storage.
- The appearance and specifications of the product may be modified for improvement without notice.
- Long time exposure of sunlight or occasional UV exposure will cause lens discoloration.
- The slug is connected to the anode. Therefore, we recommend to isolate the heat sink.
- Attaching LEDs, don't use adhesives to generate organic vapor.



## Company Information

### Published by

Seoul Semiconductor © 2013 All Rights Reserved.

### Company Information

Seoul Semiconductor ([www.SeoulSemicon.com](http://www.SeoulSemicon.com)) manufactures and packages a wide selection of light emitting diodes (LEDs) for the automotive, general illumination/lighting, Home appliance, signage and back lighting markets. The company is the world's fifth largest LED supplier, holding more than 10,000 patents globally, while offering a wide range of LED technology and production capacity in areas such as "nPola", "Acrich", the world's first commercially produced AC LED, and "Acrich MJT - Multi-Junction Technology" a proprietary family of high-voltage LEDs.

The company's broad product portfolio includes a wide array of package and device choices such as Acrich and Acirch2, high-brightness LEDs, mid-power LEDs, side-view LEDs, and through-hole type LEDs as well as custom modules, displays, and sensors.

### Legal Disclaimer

Information in this document is provided in connection with Seoul Semiconductor products. With respect to any examples or hints given herein, any typical values stated herein and/or any information regarding the application of the device, Seoul Semiconductor hereby disclaims any and all warranties and liabilities of any kind, including without limitation, warranties of non-infringement of intellectual property rights of any third party. The appearance and specifications of the product can be changed to improve the quality and/or performance without notice.

## X-ON Electronics

Largest Supplier of Electrical and Electronic Components

*Click to view similar products for [High Power LEDs - White category:](#)*

*Click to view products by [Seoul Semiconductor manufacturer:](#)*

Other Similar products are found below :

[LTW-K140SZR40](#) [B42180-08](#) [STW8Q2PA-R5-HA](#) [LTPL-P00DWS57](#) [LTW-K140SZR30](#) [LZP-D0WW00-0000](#) [SZ5-M1-WW-C8-V1/V3-FA](#) [LTW-K140SZR57](#) [LTW-K140SZR27](#) [BXRE-50C2001-C-74](#) [MP-5050-8100-27-80](#) [MP-5050-6100-65-80](#) [MP-5050-6100-50-80](#) [MP-5050-6100-40-80](#) [MP-5050-6100-30-80](#) [KW DPLS32.SB-6H6J-E5P7-EG-Z264](#) [L1V1-507003V500000](#) [KW DMLS33.SG-Z6M7-EBVFFCBB46-8E8G-700-S](#) [ASMT-MW05-NMNS1](#) [KW DPLS33.KD-HIJG-D30D144-HN-22C2-120-S](#) [KW DDLM31.EH-5J6K-A737-W4A4-140-R18](#) [GW JTLRS1.CM-K1LW-XX57-1-100-Q-R33](#) [KW DDLM31.EH-5J6K-A636-W4A4-140-R18](#) [KW DDLM31.EH-5J6K-A131-W4A4-140-R18](#) [SML-LXL8047MWCTR/3](#) [L2C5-40HG1203E0900](#) [JB3030AWT-P-U27EA0000-N0000001](#) [JK3030AWT-P-U30EA0000-N0000001](#) [JK3030AWT-P-B40EB0000-N0000001](#) [JK3030AWT-P-H30EB0000-N0000001](#) [JK3030AWT-P-H40EB0000-N0000001](#) [JK3030AWT-P-U27EB0000-N0000001](#) [JK3030AWT-P-U30EB0000-N0000001](#) [XPGBWT-HE-0000-00JE5](#) [GW JCLPS2.EM-H3H8-A131-1-65-2-R33](#) [GW PUSTA1.PM-PAPC-XX53-1-1050-R18](#) [GW CSSRM2.PM-N3N5-XX53-1](#) [GW P9LMS1.EM-NRNU-30S7-0-200-R18](#) [GW PSLPS1.EC-KSKU-5R8T-1](#) [LTPL-M03614ZS50-F1](#) [LTW-2835SZK65](#) [LTW-3030AQL40](#) [LTW-3030AZL40-EU](#) [LTW-3030BSL42](#) [LTW-3030DZL30](#) [LTW-3030SZK40](#) [LTW-3030SZK65](#) [LTW-5630AQL27](#) [LTW-5630AQL30](#) [LTW-5630AZL40-EU](#)