

**4.0 A Single-Phase Silicon Bridge Rectifier**  
Rectifier Reverse Voltage 50 to 1000V

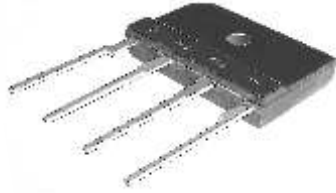

**Features**

- This series is UL listed under the Recognized Component Index, file number E142814
- Plastic package has Underwriters Laboratory Flammability Classification 94V-0
- High case dielectric strength of 1500VRMS Ideal for printed circuit boards
- High surge current capability

**Mechanical Data**

Case : Molded plastic body over passivated junctions  
 Terminals : Plated leads solderable per MIL-STD-750, Method 2026  
 Polarity : Polarity symbols molded on body  
 Mounting Position : Any(3)  
 Mounting Torque : 5 in-lbs max.  
 Weight : 0.15 ounce, 4.0 grams (approx)

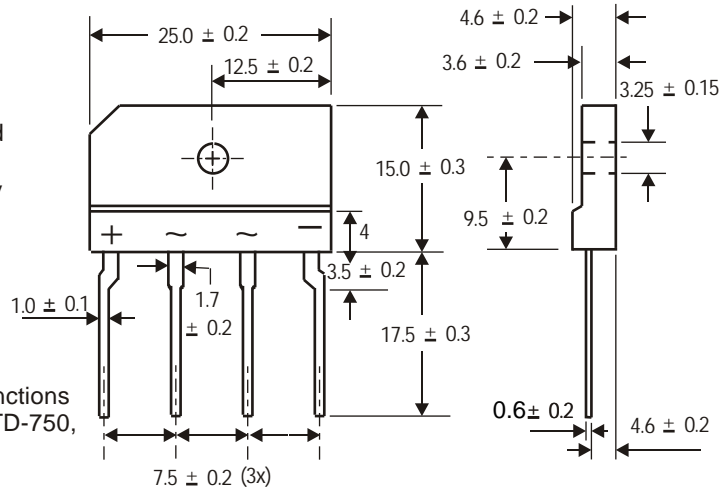

Dimensions in millimeters(1mm =0.0394")

**Maximum Ratings & Thermal Characteristics**

Rating at 25°C ambient temperature unless otherwise specified, Resistive or Inductive load, 60 Hz.  
 For Capacitive load derate current by 20%.

Parameter	Symbol	KBJ 4005	KBJ 401	KBJ 402	KBJ 404	KBJ 406	KBJ 408	KBJ 410	Unit
Maximum repetitive peak reverse voltage	VRRM	50	100	200	400	600	800	1000	V
Maximum RMS voltage	VRMS	35	70	140	280	420	560	700	V
Maximum DC blocking voltage	VDC	50	100	200	400	600	800	1000	V
Maximum average forward rectified output current T <sub>c</sub> =100°C T <sub>A</sub> =25°C	IF(AV)	4.0(1) 2.3(2)							A
Peak forward surge current single sine-wave superimposed on rated load (JEDEC Method)	IFSM	135							A
Rating for fusing ( t<8.3ms)	I <sup>2</sup> t	75							A <sup>2</sup> sec
Maximum thermal resistance per leg	RejA RejC	2.6(2) 5 (1)							°C / W
Operating junction and storage temperature range	T <sub>J</sub> , T <sub>STG</sub>	-55 to + 150							°C

**Electrical Characteristics**

Rating at 25°C ambient temperature unless otherwise specified. Resistive or Inductive load, 60Hz.  
 For Capacitive load derate by 20 %.

Parameter	Symbol	KBJ 4005	KBJ 401	KBJ 402	KBJ 404	KBJ 406	KBJ 408	KBJ 410	Unit
Maximum instantaneous forward voltage drop per leg at 4.0A	V <sub>F</sub>	1.1							V
Maximum DC reverse current at rated DC blocking voltage per leg T <sub>A</sub> =25°C T <sub>A</sub> =125°C	I <sub>R</sub>	10 250							μA

- Notes:** (1)Unit case mounted on Al plate heatsink.  
 (2)Units mounted on P.C.B. with 0.5x0.5"(12x12mm) copper pads and 0.375"(9.5) lead length.  
 (3)Recommended mounting position is to bolt down on heat sink with silicone thermal compound for maximum heat transfer with #6 screw.

**Rating and Characteristic Curves ( TA=25°C Unless otherwise noted )**  
**KBJ4005 thru KBJ410**

**Fig. 1 Derating Curve for Output Rectified Current**

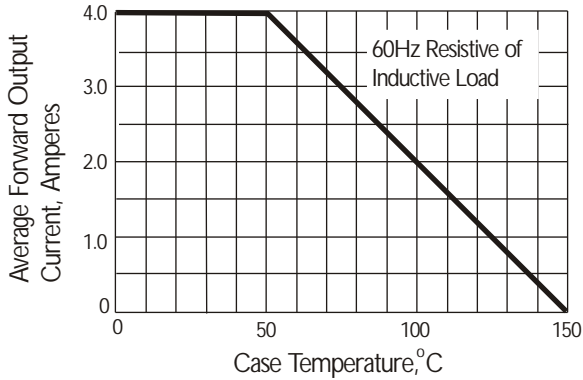

**Fig. 2 Maximum Non-repetitive Peak Forward Surge Current**

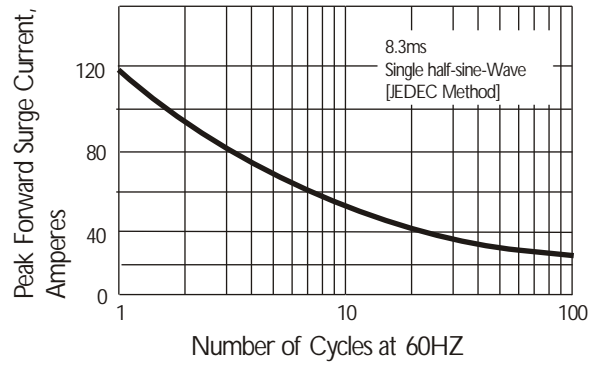

**Fig. 3 Typical Instantaneous Forward Characteristics**

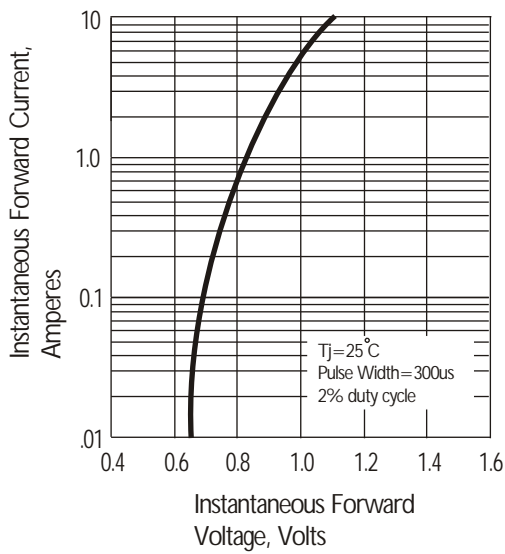

**Fig. 4 Typical Reverse Characteristics at Tj=25°C**

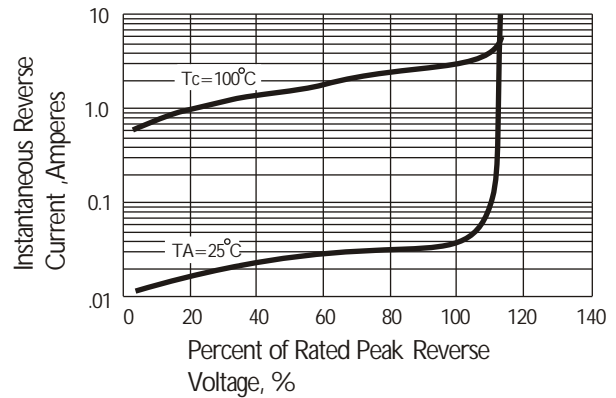

**Fig. 5 Typical Junction Capacitance**

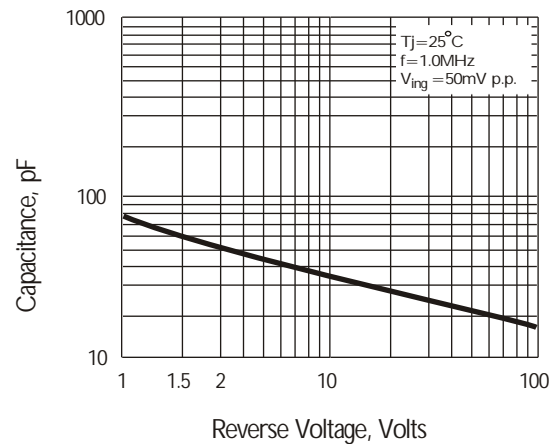

## X-ON Electronics

Largest Supplier of Electrical and Electronic Components

*Click to view similar products for [Bridge Rectifiers](#) category:*

*Click to view products by [SEP](#) manufacturer:*

Other Similar products are found below :

[MB2510](#) [MB252](#) [MB356G](#) [MB358G](#) [90MT160KPBF](#) [GBJ1504-BP](#) [GBU10B-BP](#) [GBU15K-BP](#) [GBU4A-BP](#) [GBU4D-BP](#) [GBU6B-E3/45](#)  
[DB101-BP](#) [DF01](#) [DF10SA-E345](#) [BU1508-E3/45](#) [BU1510-E3/45](#) [KBPC50-10S](#) [RS405GL-BP](#) [GBJ1502-BP](#) [GBU6M](#) [GSIB1520-E3/45](#)  
[2KBB10](#) [36MB140A](#) [TB102M](#) [MB1510](#) [MB86](#) [TL401G](#) [MDA920A2](#) [TU602](#) [TU810](#) [MP5010W-BP](#) [MP501W-BP](#) [MP502-BP](#)  
[BR84DTP204](#) [BU1508-E3/51](#) [KBPC25-02](#) [VS-110MT120KPBF](#) [VS-2KBB60](#) [VS-60MT120KPBF](#) [VS-60MT80KPBF](#) [DB105-BP](#) [DF1510S](#)  
[VS-40MT160PAPBF](#) [VISKBU8K-E4/51](#) [36MT100](#) [GBU4G-BP](#) [GBU6B-E3/51](#) [DF15005S-E3/77](#) [GSIB15A80-E3/45](#) [DB104-BP](#)