

8.0 A Single-Phase Silicon Bridge Rectifier
Rectifier Reverse Voltage 50 to 1000V

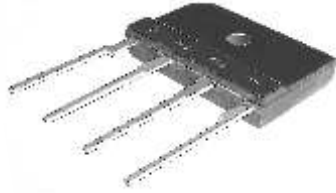

Features

- This series is UL listed under the Recognized Component Index, file number E142814
- Plastic package has Underwriters Laboratory Flammability Classification 94V-0
- High case dielectric strength of 1500VRMS Ideal for printed circuit boards
- High surge current capability

Mechanical Data

Case : Molded plastic body over passivated junctions
 Terminals : Plated leads solderable per MIL-STD-750, Method 2026
 Polarity : Polarity symbols molded on body
 Mounting Position : Any(3)
 Mounting Torque : 5 in-lbs max.
 Weight : 0.15 ounce, 4.0 grams (approx)

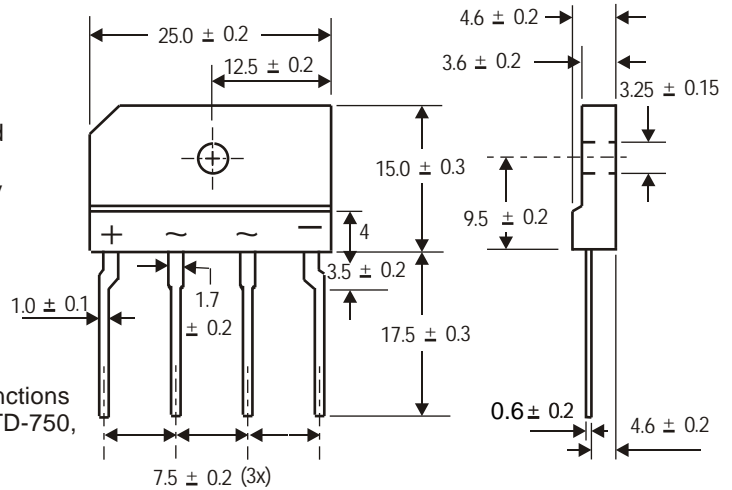

Dimensions in millimeters(1mm =0.0394")

Maximum Ratings & Thermal Characteristics

Rating at 25°C ambient temperature unless otherwise specified, Resistive or Inductive load, 60 Hz.
 For Capacitive load derate current by 20%.

Parameter	Symbol	KBJ 8005	KBJ 801	KBJ 802	KBJ 804	KBJ 8J	KBJ 808	KBJ 810	Unit
Maximum repetitive peak reverse voltage	VRRM	50	100	200	400	600	800	1000	V
Maximum RMS voltage	VRMS	35	70	140	280	420	560	700	V
Maximum DC blocking voltage	VDC	50	100	200	400	600	800	1000	V
Maximum average forward rectified output current <small>T_c =100°C T_A =25°C</small>	IF(AV)	8.0							A
Peak forward surge current single sine-wave superimposed on rated load (JEDEC Method)	IFSM	175							A
Rating for fusing (t<8.3ms)	I ² t	125							A ² sec
Maximum thermal resistance per leg	RejA RejC	2.6(2) 5 (1)							°C / W
Operating junction and storage temperature range	TJ, TSTG	-55 to + 150							°C

Electrical Characteristics

Rating at 25°C ambient temperature unless otherwise specified. Resistive or Inductive load, 60Hz.
 For Capacitive load derate by 20 %.

Parameter	Symbol	KBJ 8005	KBJ 801	KBJ 802	KBJ 804	KBJ 8J	KBJ 808	KBJ 810	Unit
Maximum instantaneous forward voltage drop per leg at 4.0A	VF	1.0							V
Maximum DC reverse current at rated DC blocking voltage per leg <small>T_A =25°C T_A =125°C</small>	IR	10 250							μA

- Notes:** (1)Unit case mounted on Al plate heatsink.
 (2)Units mounted on P.C.B. with 0.5x0.5"(12x12mm) copper pads and 0.375"(9.5) lead length.
 (3)Recommended mounting position is to bolt down on heat sink with silicone thermal compound for maximum heat transfer with #6 screw.

Rating and Characteristic Curves ($T_A=25^{\circ}\text{C}$ Unless otherwise noted)

KBJ8005 thru KBJ810

Fig. 1 Derating Curve for Output Rectified Current

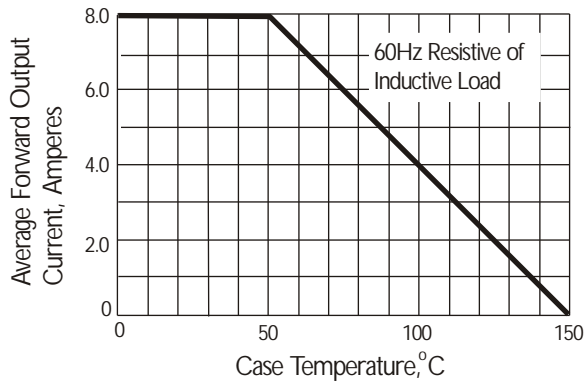

Fig. 2 Maximum Non-repetitive Peak Forward Surge Current

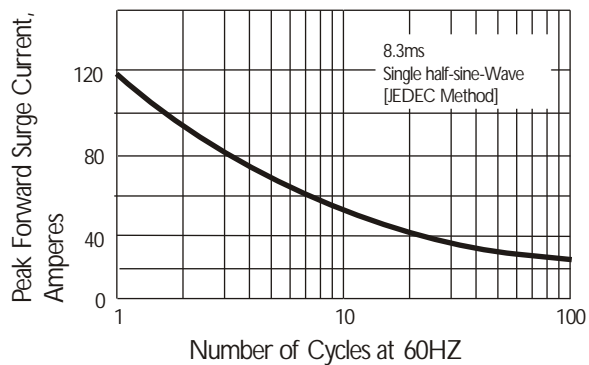

Fig. 3 Typical Instantaneous Forward Characteristics

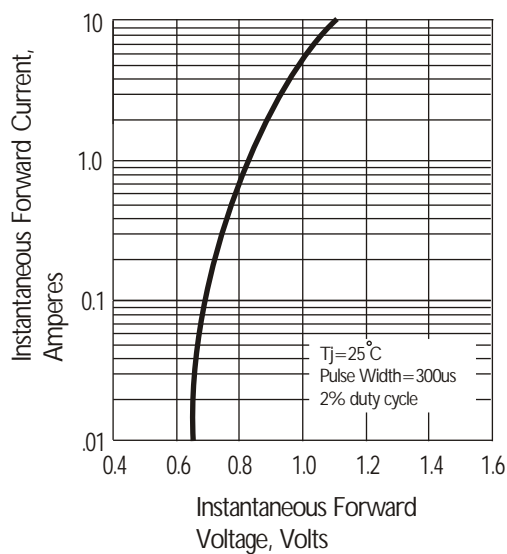

Fig. 4 Typical Reverse Characteristics at $T_J=25^{\circ}\text{C}$

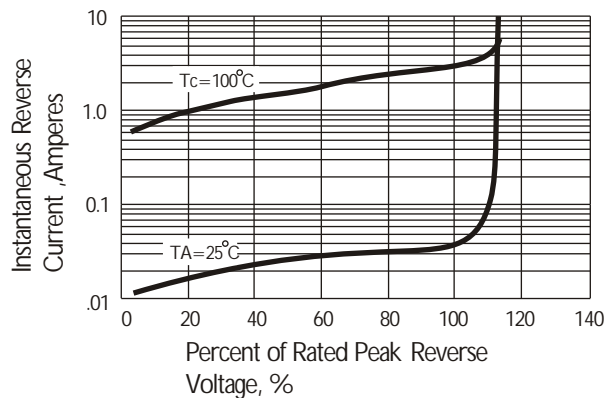
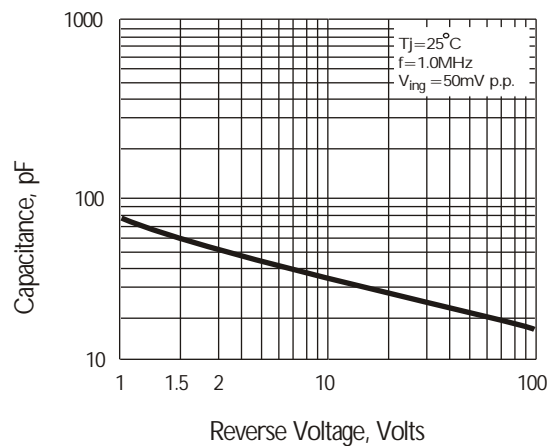

Fig. 5 Typical Junction Capacitance



X-ON Electronics

Largest Supplier of Electrical and Electronic Components

Click to view similar products for [Bridge Rectifiers](#) category:

Click to view products by [SEP](#) manufacturer:

Other Similar products are found below :

[MB2510](#) [MB252](#) [MB356G](#) [MB358G](#) [90MT160KPBF](#) [GBJ1504-BP](#) [GBU10B-BP](#) [GBU15K-BP](#) [GBU4A-BP](#) [GBU4D-BP](#) [GBU6B-E3/45](#)
[DB101-BP](#) [DF01](#) [DF10SA-E345](#) [BU1508-E3/45](#) [BU1510-E3/45](#) [KBPC50-10S](#) [RS405GL-BP](#) [GBJ1502-BP](#) [GBU6M](#) [GSIB1520-E3/45](#)
[2KBB10](#) [36MB140A](#) [TB102M](#) [MB1510](#) [MB86](#) [TL401G](#) [MDA920A2](#) [TU602](#) [TU810](#) [MP5010W-BP](#) [MP501W-BP](#) [MP502-BP](#)
[BR84DTP204](#) [BU1508-E3/51](#) [KBPC25-02](#) [VS-110MT120KPBF](#) [VS-2KBB60](#) [VS-60MT120KPBF](#) [VS-60MT80KPBF](#) [DB105-BP](#) [DF1510S](#)
[VS-40MT160PAPBF](#) [VISKBU8K-E4/51](#) [36MT100](#) [GBU4G-BP](#) [GBU6B-E3/51](#) [DF15005S-E3/77](#) [GSIB15A80-E3/45](#) [DB104-BP](#)