

# KBU15005 thru KBU1510

## 15 A Single-Phase Silicon Bridge Rectifier Rectifier Reverse Voltage 50 to 1000V

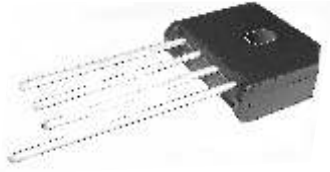

### Features

- Ideal for P.C. Board mounting
- High surge current capability
- This series is UL listed under the Recognized Component Index, file number E142814
- The plastic material used carries Underwriters Laboratory flammability recognition 94V-0
- High temperature soldering guaranteed 265°C /10 seconds at 5 lbs (2.3kg) tension

### Mechanical Data

Case: Molded plastic body  
 Terminals: Plated leads solderable per MIL-STD-202, Method 208  
 Polarity: Polarity symbols molded on body  
 Mounting Position:: Any  
 Mounting Torque: 5 in-lbs max.  
 Weight: 0.3 ounce, 8.0 grams (approx)

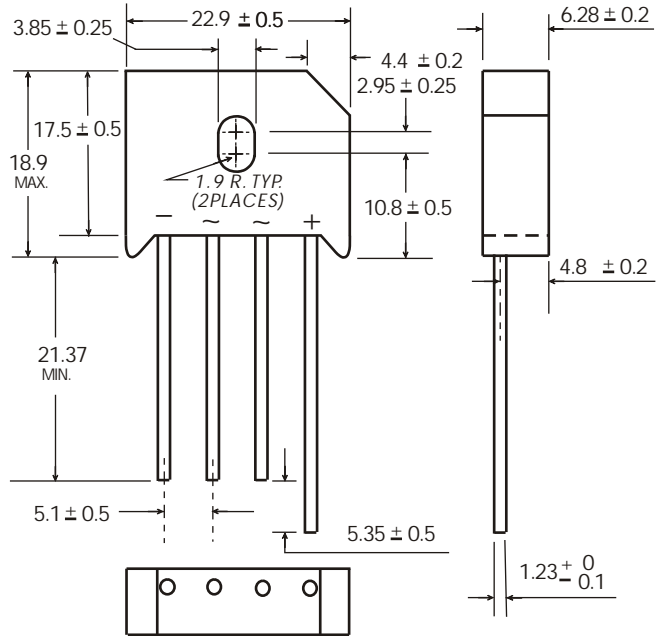

Dimensions in millimeters(1mm =0.0394")

### Maximum Ratings & Thermal Characteristics

Rating at 25°C ambient temperature unless otherwise specified, Resistive or Inductive load, 60 Hz.  
 For Capacitive load derate current by 20%.

Parameter	Symbol	KBU 15005	KBU 1501	KBU 1502	KBU 1504	KBU 1506	KBU 1508	KBU 1510	unit
Maximum repetitive peak reverse voltage	VRRM	50	100	200	400	600	800	1000	V
Maximum RMS bridge input voltage	VRMS	35	70	140	280	420	560	700	V
Maximum DC blocking voltage	VDC	50	100	200	400	600	800	1000	V
Maximum average forward rectified output current at TA=100°C	IF(AV)	15(7.5)							A
Peak forward surge current single sine-wave superimposed on rated load (JEDEC Method)	IFSM	300							A
Rating for fusing ( t<8.3ms)	I <sup>2</sup> t	300							A <sup>2</sup> sec
Typical thermal resistance per element (1)	ReJA	2.7							°C / W
Operating junction and storage temperature range	TJ, TSTG	-55 to + 150							°C

### Electrical Characteristics

Rating at 25°C ambient temperature unless otherwise specified. Resistive or Inductive load, 60Hz.  
 For Capacitive load derate by 20 %.

Parameter	Symbol	KBU 15005	KBU 1501	KBU 1502	KBU 1504	KBU 1506	KBU 1508	KBU 1510	Unit
Maximum instantaneous forward voltage drop per leg at 10A	VF	1.05							V
Maximum DC reverse current at rated TA =25°C DC blocking voltage per element TA =125°C	IR	10 500							μA

**Notes:** (1)Thermal resistance from Junction to Ambient on P.C.board mounting.

# Rating and Characteristic Curves ( $T_A=25^{\circ}\text{C}$ Unless otherwise noted )

## KBU15005 thru KBU1510

**Fig. 1 Derating Curve for Output Rectified Current**

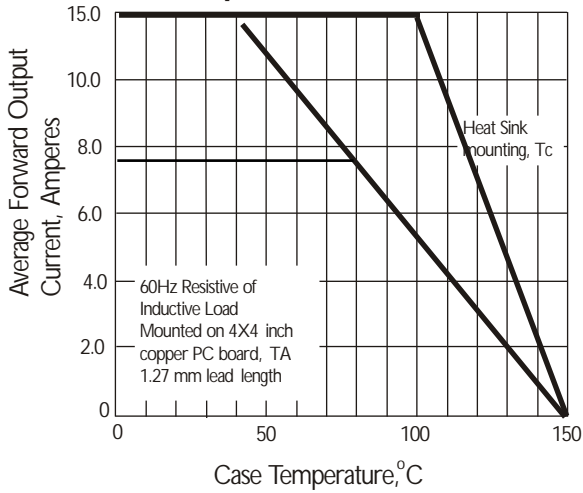

**Fig. 2 Maximum Non-repetitive Peak Forward Surge Current**

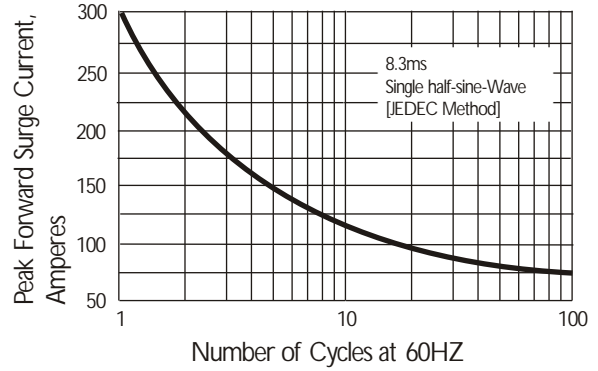

**Fig. 3 Typical Instantaneous Forward Characteristics**

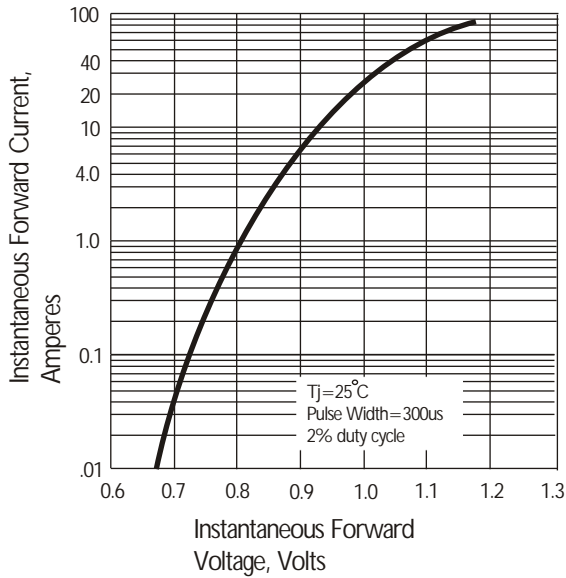

**Fig. 4 Typical Reverse Characteristics**

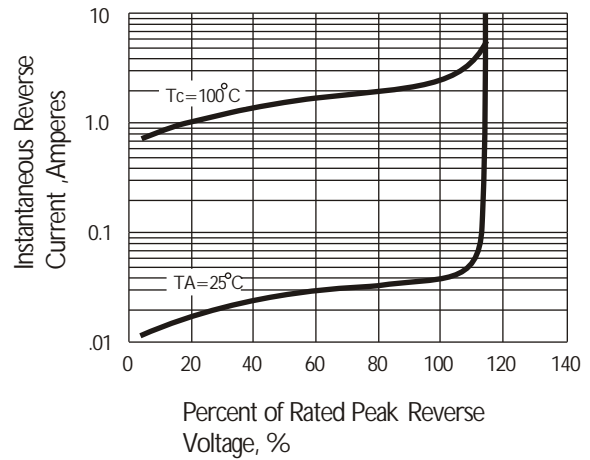

**Fig. 5 Typical Junction Capacitance**

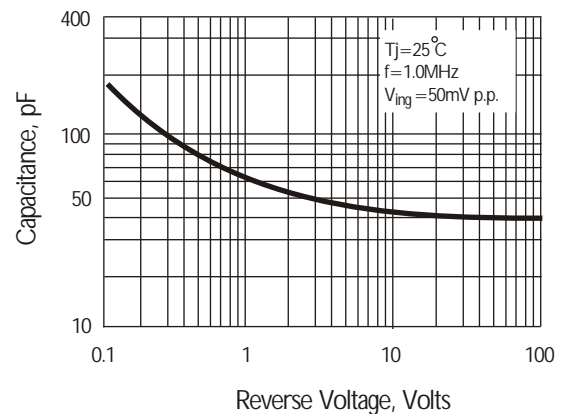

## X-ON Electronics

Largest Supplier of Electrical and Electronic Components

*Click to view similar products for [Bridge Rectifiers](#) category:*

*Click to view products by [SEP](#) manufacturer:*

Other Similar products are found below :

[MB2510](#) [MB252](#) [MB356G](#) [MB358G](#) [MP358-BP](#) [90MT160KPBF](#) [GBJ1504-BP](#) [GBU10B-BP](#) [GBU15J-BP](#) [GBU15K-BP](#) [GBU4A-BP](#)  
[GBU4D-BP](#) [GSIB680-E3/45](#) [DB101-BP](#) [DF01](#) [DF10SA-E345](#) [BU1508-E3/45](#) [BU1510-E3/45](#) [KBPC50-10S](#) [RS405GL-BP](#) [G5SBA60-](#)  
[E3/51](#) [GBJ1502-BP](#) [GBU10J-BP](#) [GBU4J-BP](#) [GBU6M](#) [GBU8D-BP](#) [GBU8J-BP](#) [GSIB1520-E3/45](#) [TB102M](#) [MB1510](#) [MB6M-G](#) [MB86](#)  
[TL401G](#) [MDA920A2](#) [TU602](#) [TU810](#) [MP501W-BP](#) [MP502-BP](#) [BR1005-BP](#) [BR101-BP](#) [BR84DTP204](#) [BU1010A-E3/51](#) [BU1508-E3/51](#)  
[BU2006-E3/45](#) [BU2008-E3/51](#) [US15KB80R-7000](#) [KBPC25-02](#) [VS-60MT120KPBF](#) [DB105-BP](#) [DF1510S](#)