

压敏电阻

Metal Oxide Varistor (MOV)

SFV20D 系列



描述

金属氧化物压敏电阻 Metal Oxide Varistor (MOV) 是以氧化锌 (ZnO) 为主要成分的非线性电阻元件。其电阻对外加电压的变化敏感, 在阈值电压以下, 电阻非常高, 流过的电流极小, 相当于关闭的阀门, 当电压超过阈值时, 电阻急剧下降, 流过的电流激增, 相当于阀门打开, 利用该特性, 可以抑制电路中经常出现的异常过电压, 保护电路免受过电压的损害。

金属氧化物压敏电阻 Metal Oxide Varistor (MOV) 广泛应用于光伏、通信、防雷器、电源和插座等领域, 限制电路中的瞬态过电压和吸收浪涌能量。

赛尔特(SETsafe | SETfuse) 公司的金属氧化物压敏电阻 Metal Oxide Varistor (MOV) 具有最大峰值电流: (0.75~70) kA; 最大连续工作电压: (14~750) VAC; 安规认证UL、cUL、TUV、CQC; 符合RoHS、REACH要求。

产品结构

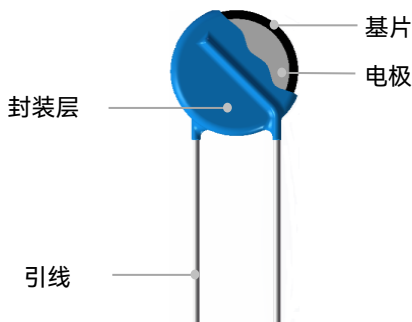

引线类型

引线类型		代码
直型引线		A
外弯型引线		C
微直型引线		I
Y型引线		D

认证信息

认证标志	执行标准	赛尔特获得的档案号、认证号
	UL 1449 5 th Edition	E322662
	CSA C22.2 NO.269.5-17	E322662
	EN IEC 61051-1:2018 EN IEC 61051-2:2021 IEC 61051-2-2:1991 Annex G.8.1 of IEC 62368-1:2018	J 50239739
	GB/T 10193-1997 GB/T 10194-1997 GB 4943.1-2022 IEC 61051-2:1991+Amd1:2009	CQC12001084355

应用领域

- 电源
- 家用电器
- 工业设备
- 防雷插座
- 通信电源

压敏电阻

Metal Oxide Varistor (MOV)

SFV20D 系列

产品标识

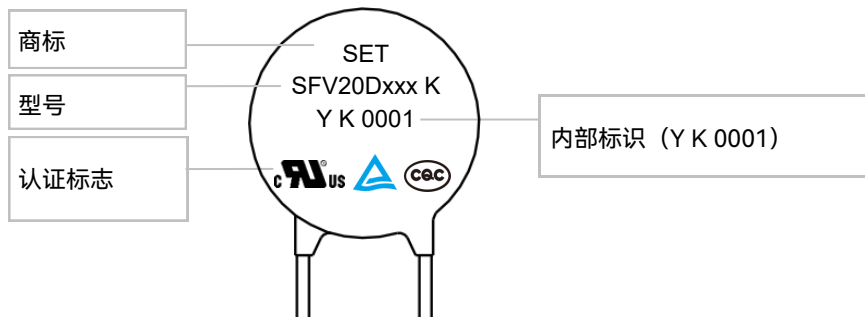

温度降额曲线

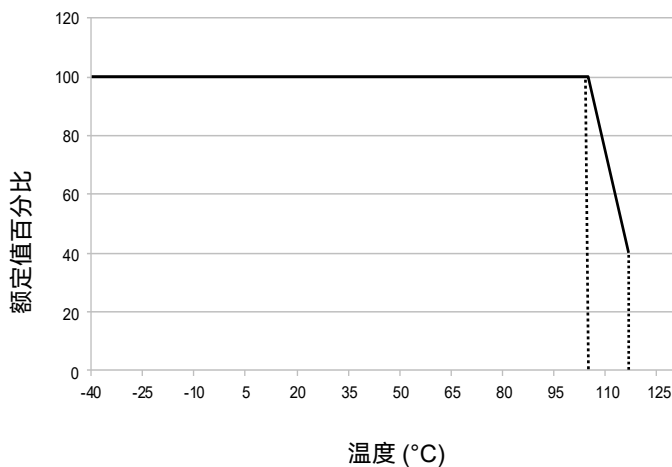

105 °C 系列温度降额曲线

备注:

应用环境温度超过 105 °C 时，峰值电流和能量额定值应按照上述曲线相应的降低。

温度降额的技术参数

项目	值	单位
工作温度	-40 ~ +105	°C
存储温度	-40 ~ +125	°C
耐电压	≥2500	V _{ac}
绝缘电阻	≥100	MΩ

压敏电阻

Metal Oxide Varistor (MOV)

SFV20D 系列

尺寸 (mm)

型号	L (Min.)	H (Max.)	T (Max.)	D (Max.)	d	F	F ₁	A (Max.)
SFV20D220K	20	25.5	5.3	23	1.00±0.05	10.0±0.5	1.3 ~ 2.7	27.5
SFV20D270K	20	25.5	5.6	23	1.00±0.05	10.0±0.5	1.4 ~ 2.9	27.5
SFV20D330K	20	25.5	5.9	23	1.00±0.05	10.0±0.5	1.5 ~ 3.1	27.5
SFV20D390K	20	25.5	6.2	23	1.00±0.05	10.0±0.5	1.6 ~ 3.3	27.5
SFV20D470K	20	25.5	5.4	23	1.00±0.05	10.0±0.5	1.4 ~ 2.9	27.5
SFV20D560K	20	25.5	5.6	23	1.00±0.05	10.0±0.5	1.5 ~ 3.1	27.5
SFV20D680K	20	25.5	5.9	23	1.00±0.05	10.0±0.5	1.6 ~ 3.4	27.5
SFV20D820K	20	25.5	4.8	23	1.00±0.05	10.0±0.5	1.4 ~ 2.8	27.5
SFV20D101K	20	25.5	5.0	23	1.00±0.05	10.0±0.5	1.5 ~ 3.0	27.5
SFV20D121K	20	25.5	5.2	23	1.00±0.05	10.0±0.5	1.6 ~ 3.2	27.5
SFV20D151K	20	25.5	5.5	23	1.00±0.05	10.0±0.5	1.7 ~ 3.5	27.5
SFV20D181K	20	25.5	4.7	23	1.00±0.05	10.0±0.5	1.0 ~ 2.9	27.5
SFV20D201K	20	25.5	4.8	23	1.00±0.05	10.0±0.5	1.0 ~ 3.0	27.5
SFV20D221K	20	25.5	4.9	23	1.00±0.05	10.0±0.5	1.0 ~ 3.0	27.5
SFV20D241K	20	25.5	5.0	23	1.00±0.05	10.0±0.5	1.1 ~ 3.1	27.5
SFV20D271K	20	25.5	5.2	23	1.00±0.05	10.0±0.5	1.3 ~ 3.3	27.5
SFV20D301K	20	25.5	5.3	23	1.00±0.05	10.0±0.5	1.4 ~ 3.4	27.5
SFV20D331K	20	25.5	5.5	23	1.00±0.05	10.0±0.5	1.6 ~ 3.6	27.5
SFV20D361K	20	25.5	5.6	23	1.00±0.05	10.0±0.5	1.7 ~ 3.7	27.5
SFV20D391K	20	25.5	5.8	23	1.00±0.05	10.0±0.5	1.9 ~ 3.9	27.5
SFV20D431K	20	25.5	6.0	23	1.00±0.05	10.0±0.5	2.0 ~ 4.0	27.5
SFV20D471K	20	25.5	6.2	23	1.00±0.05	10.0±0.5	2.2 ~ 4.2	27.5
SFV20D511K	20	25.5	6.4	23	1.00±0.05	10.0±0.5	2.4 ~ 4.4	27.5
SFV20D561K	20	25.5	6.6	23	1.00±0.05	10.0±0.5	2.7 ~ 4.7	27.5
SFV20D621K	20	25.5	6.9	23	1.00±0.05	10.0±0.5	3.0 ~ 5.0	27.5
SFV20D681K	20	25.5	7.2	23	1.00±0.05	10.0±0.5	3.2 ~ 5.2	27.5
SFV20D751K	20	25.5	7.6	23	1.00±0.05	10.0±0.5	3.6 ~ 5.6	27.5
SFV20D821K	20	25.5	7.9	23	1.00±0.05	10.0±0.5	3.9 ~ 5.9	27.5
SFV20D911K	20	25.5	8.4	23	1.00±0.05	10.0±0.5	4.3 ~ 6.3	27.5
SFV20D102K	20	25.5	8.8	23	1.00±0.05	10.0±0.5	4.8 ~ 6.8	27.5
SFV20D112K	20	25.5	9.3	23	1.00±0.05	10.0±0.5	5.2 ~ 7.2	27.5
SFV20D122K	20	25.5	9.8	23	1.00±0.05	10.0±0.5	5.7 ~ 7.7	27.5

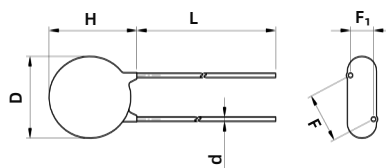
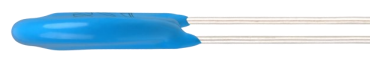

直型引线 (代码 A)

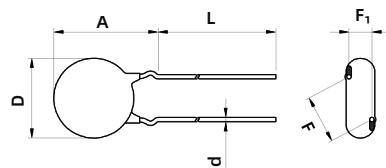

外弯型引线 (代码 C)

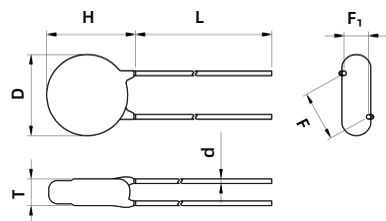

微直型引线 (代码 I)

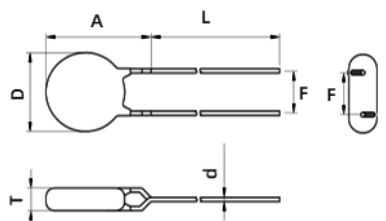

Y型引线 (代码 D)

备注：以上数据仅供参考。

压敏电阻

Metal Oxide Varistor (MOV)

SFV20D 系列

型号说明

SFV 20 D 471 - K P K A BUL - 001

流水号

包装 & 引脚长度

散装: 散装+标准长度 (L28)

散装: 散装+切脚至长度 3.5 mm (范围: 2.5 ~ 6 mm)

散装: 散装+特殊脚长 (范围: 28 ~ 32 mm)

编带+盒装 (孔距12.7 mm)

编带+盒装 (孔距15.0 mm)

编带+卷轴 (孔距12.7 mm)

编带+卷轴 (孔距15.0 mm)

备注: 0 / 1表示产品的位置

0: 代表两孔中间

1: 代表跨孔

引脚类型

A: 直线型引线

C: 外弯型引线

D: Y型引线

I: 微直线型引线

浪涌等级

S: 通用型

K: 标准型

H: 高能型

Q: 耐冲击型

工作温度

P: 环氧树脂包封 105 °C

电压公差

K: $\pm 10\%$

标称压敏电压

220: $22 \times 10^0 = 22 \text{ V}$ 471: $47 \times 10^1 = 470 \text{ V}$ 122: $12 \times 10^2 = 1200 \text{ V}$

形状

D: 圆形

基片尺寸

圆形 20: 20 mm

产品类别

压敏电阻

*提示:





产品目录中的“型号说明”仅供选型用，下订单前请联系销售人员获取“产品规格书”，请使用“产品规格书”里面的“型号”以及对应的“产品编码 Product Code”，确保交易产品的“产品编码 Product Code”是唯一的。

压敏电阻

Metal Oxide Varistor (MOV)

SFV20D 系列

技术参数





型号	浪涌等级	最大连续工作电压		压敏电压		箝制电压		最大峰值电流	最大能量	静态电容	认证信息			
		VAC	VDC	Min.	Max.	V _C	I _P	S		(pF)				
		(V)	(V)	(V)	(V)	(V)	(A)	(kA)	(J)		UL	cUL	TUV	CQC
SFV20D220K	S	14	18	20	24	43	20	2.0	14	18500	●	●	●	●
SFV20D270K	S	17	22	24	31	53	20	2.0	16	13000	●	●	●	●
SFV20D330K	S	20	26	30	36	65	20	2.0	23	11500	●	●	●	●
SFV20D390K	S	25	31	35	43	77	20	2.0	26	8500	●	●	●	●
SFV20D470K	S	30	38	42	52	93	20	2.0	30	8000	●	●	●	●
SFV20D560K	S	35	45	50	62	110	20	2.0	41	7000	●	●	●	●
SFV20D680K	S	40	56	61	75	135	20	2.0	46	6200	●	●	●	●
SFV20D820K	S	50	65	74	90	135	100	6.5	38	4900	●	●	●	●
SFV20D101K	S	60	85	90	110	165	100	6.5	45	4000	●	●	●	●
SFV20D121K	S	75	100	108	132	200	100	6.5	55	3400	●	●	●	●
SFV20D151K	S	95	125	135	165	250	100	6.5	70	2700	●	●	●	●
SFV20D181K	S	115	150	162	198	300	100	6.5	85	2200	●	●	●	●
SFV20D201K	S	130	170	180	220	340	100	6.5	95	2000	●	●	●	●
SFV20D221K	S	140	180	198	242	360	100	6.5	100	1800	●	●	●	●
SFV20D241K	S	150	200	216	264	395	100	6.5	108	1650	●	●	●	●
SFV20D271K	S	175	225	243	297	455	100	6.5	127	1500	●	●	●	●
SFV20D301K	S	190	250	270	330	500	100	6.5	136	1300	●	●	●	●
SFV20D331K	S	210	275	297	363	550	100	6.5	150	1200	●	●	●	●
SFV20D361K	S	230	300	324	396	595	100	6.5	163	1100	●	●	●	●
SFV20D391K	S	250	320	351	429	650	100	6.5	180	1000	●	●	●	●
SFV20D431K	S	275	350	387	473	710	100	6.5	190	930	●	●	●	●
SFV20D471K	S	300	385	423	517	775	100	6.5	220	850	●	●	●	●
SFV20D511K	S	320	415	459	561	845	100	6.5	220	780	●	●	●	●
SFV20D561K	S	350	460	504	616	925	100	6.5	220	710	●	●	●	●
SFV20D621K	S	385	505	558	682	1025	100	6.5	220	650	●	●	●	●
SFV20D681K	S	420	560	612	748	1120	100	6.5	230	600	●	●	●	●
SFV20D751K	S	460	615	675	825	1240	100	6.5	255	530	●	●	●	●
SFV20D821K	S	510	670	738	902	1355	100	6.5	282	500	●	●	●	●
SFV20D911K	S	550	745	819	1001	1500	100	6.5	310	440	●	●	●	●
SFV20D102K	S	625	825	900	1100	1650	100	6.5	342	400	●	●	●	●
SFV20D112K	S	680	895	990	1210	1815	100	6.5	383	360	●	●	●	●
SFV20D122K	S	750	990	1080	1320	1980	100	6.5	408	320	●	●	●	●

备注：● 已认证 ○ 无认证 ● 满足RoHS、REACH要求

压敏电阻

Metal Oxide Varistor (MOV)

SFV20D 系列

型号	浪涌等级	最大连续工作电压		压敏电压		箝制电压		最大峰值电流	最大能量	静态电容	认证信息			
		VAC	VDC	Min.	Max.	V _C	I _P	K		(pF)				
		(V)	(V)	(V)	(V)	(V)	(A)	(kA)	(J)		UL	cUL	TUV	CQC
SFV20D220K	K	14	18	20	24	43	20	3	16	18500	●	●	●	●
SFV20D270K	K	17	22	24	31	53	20	3	19	13000	●	●	●	●
SFV20D330K	K	20	26	30	36	65	20	3	24	11500	●	●	●	●
SFV20D390K	K	25	31	35	43	77	20	3	28	8500	●	●	●	●
SFV20D470K	K	30	38	42	52	93	20	3	34	8000	●	●	●	●
SFV20D560K	K	35	45	50	62	110	20	3	41	7000	●	●	●	●
SFV20D680K	K	40	56	61	75	135	20	3	49	6200	●	●	●	●
SFV20D820K	K	50	65	74	90	135	100	10	56	4900	●	●	●	●
SFV20D101K	K	60	85	90	110	165	100	10	70	4000	●	●	●	●
SFV20D121K	K	75	100	108	132	200	100	10	85	3400	●	●	●	●
SFV20D151K	K	95	125	135	165	250	100	10	106	2700	●	●	●	●
SFV20D181K	K	115	150	162	198	300	100	10	130	2200	●	●	●	●
SFV20D201K	K	130	170	180	220	340	100	10	140	2000	●	●	●	●
SFV20D221K	K	140	180	198	242	360	100	10	155	1800	●	●	●	●
SFV20D241K	K	150	200	216	264	395	100	10	168	1650	●	●	●	●
SFV20D271K	K	175	225	243	297	455	100	10	190	1500	●	●	●	●
SFV20D301K	K	190	250	270	330	500	100	10	210	1300	●	●	●	●
SFV20D331K	K	210	275	297	363	550	100	10	228	1200	●	●	●	●
SFV20D361K	K	230	300	324	396	595	100	10	255	1100	●	●	●	●
SFV20D391K	K	250	320	351	429	650	100	10	275	1000	●	●	●	●
SFV20D431K	K	275	350	387	473	710	100	10	305	930	●	●	●	●
SFV20D471K	K	300	385	423	517	775	100	10	350	850	●	●	●	●
SFV20D511K	K	320	415	459	561	845	100	10	360	780	●	●	●	●
SFV20D561K	K	350	460	504	616	925	100	10	380	710	●	●	●	●
SFV20D621K	K	385	505	558	682	1025	100	10	390	650	●	●	●	●
SFV20D681K	K	420	560	612	748	1120	100	10	400	600	●	●	●	●
SFV20D751K	K	460	615	675	825	1240	100	10	420	530	●	●	●	●
SFV20D821K	K	510	670	738	902	1355	100	10	460	500	●	●	●	●
SFV20D911K	K	550	745	819	1001	1500	100	10	510	440	●	●	●	●
SFV20D102K	K	625	825	900	1100	1650	100	10	565	400	●	●	●	●
SFV20D112K	K	680	895	990	1210	1815	100	10	620	360	●	●	●	●
SFV20D122K	K	750	990	1080	1320	1980	100	10	660	320	●	●	●	●

备注: ● 已认证 ○ 无认证 ● 满足RoHS、REACH要求

压敏电阻

Metal Oxide Varistor (MOV)

SFV20D 系列

技术参数

型号	浪涌等级	最大连续工作电压		压敏电压		箝制电压		最大峰值电流	最大能量	静态电容	认证信息			
		VAC	VDC	Min.	Max.	V _C	I _P	H		(pF)				
		(V)	(V)	(V)	(V)	(V)	(A)	(kA)	(J)		UL	cUL	TUV	CQC
SFV20D201K	H	130	170	180	220	340	100	13	300	2000	●	●	●	●
SFV20D221K	H	140	180	198	242	360	100	13	320	1800	●	●	●	●
SFV20D241K	H	150	200	216	264	395	100	13	340	1650	●	●	●	●
SFV20D271K	H	175	225	243	297	455	100	13	380	1500	●	●	●	●
SFV20D301K	H	190	250	270	330	500	100	13	400	1300	●	●	●	●
SFV20D331K	H	210	275	297	363	550	100	13	440	1200	●	●	●	●
SFV20D361K	H	230	300	324	396	595	100	13	470	1100	●	●	●	●
SFV20D391K	H	250	320	351	429	650	100	13	510	1000	●	●	●	●
SFV20D431K	H	275	350	387	473	710	100	13	550	930	●	●	●	●
SFV20D471K	H	300	385	423	517	775	100	13	600	850	●	●	●	●
SFV20D511K	H	320	415	459	561	845	100	13	650	780	●	●	●	●
SFV20D561K	H	350	460	504	616	925	100	13	700	710	●	●	●	●
SFV20D621K	H	385	505	558	682	1025	100	13	700	650	●	●	●	●
SFV20D681K	H	420	560	612	748	1120	100	13	800	600	●	●	●	●

备注：● 已认证 ○ 无认证 ● 满足RoHS、REACH要求

压敏电阻

Metal Oxide Varistor (MOV)

SFV20D 系列

技术参数

型号	浪涌等级	最大连续工作电压		压敏电压		箝制电压		最大峰值电流	最大能量	静态电容	认证信息			
		VAC	VDC	Min.	Max.	V_C	I_P	Q		(pF)				
		(V)	(V)	(V)	(V)	(V)	(A)	(kV)	(J)		UL	cUL	TUV	CQC
SFV20D201K	Q	130	170	180	220	340	100	10	140	2000	●	●	●	●
SFV20D221K	Q	140	180	198	242	360	100	10	155	1800	●	●	●	●
SFV20D241K	Q	150	200	216	264	395	100	10	168	1650	●	●	●	●
SFV20D271K	Q	175	225	243	297	455	100	10	190	1500	●	●	●	●
SFV20D301K	Q	190	250	270	330	500	100	10	210	1300	●	●	●	●
SFV20D331K	Q	210	275	297	363	550	100	10	228	1200	●	●	●	●
SFV20D361K	Q	230	300	324	396	595	100	10	255	1100	●	●	●	●
SFV20D391K	Q	250	320	351	429	650	100	10	275	1000	●	●	●	●
SFV20D431K	Q	275	350	387	473	710	100	10	305	930	●	●	●	●
SFV20D471K	Q	300	385	423	517	775	100	10	350	850	●	●	●	●
SFV20D511K	Q	320	415	459	561	845	100	10	360	780	●	●	●	●
SFV20D561K	Q	350	460	504	616	925	100	10	380	710	●	●	●	●
SFV20D621K	Q	385	505	558	682	1025	100	10	390	650	●	●	●	●
SFV20D681K	Q	420	560	612	748	1120	100	10	400	600	●	●	●	●

备注：● 已认证 ○ 无认证 ● 满足RoHS、REACH要求

压敏电阻

Metal Oxide Varistor (MOV)

SFV20D 系列

性能曲线 (仅供参考)

● 最大峰值电流降额曲线

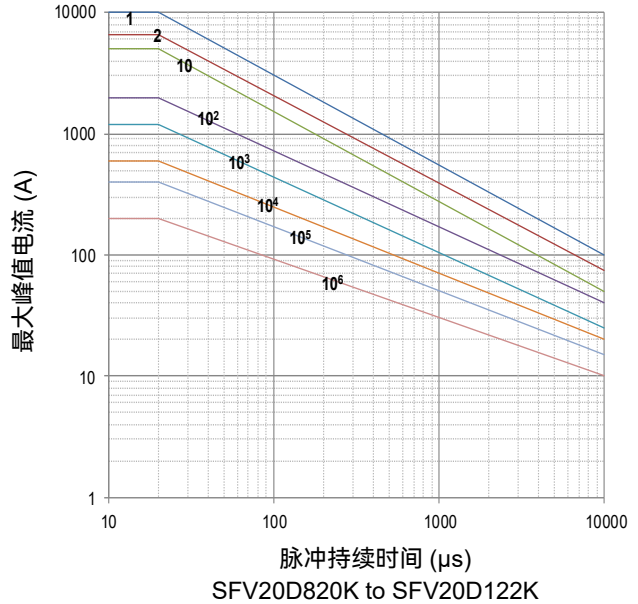
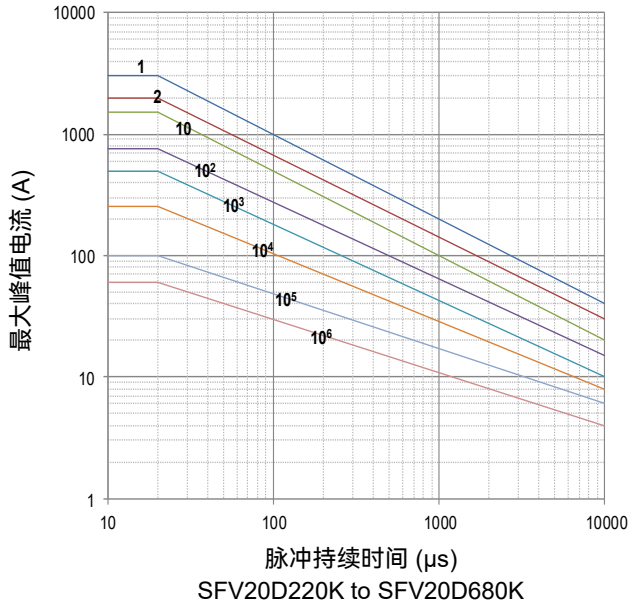

备注：1,2,10,10²,10³,10⁴,10⁵,10⁶ 表示重复冲击次数。

● 伏安特性曲线

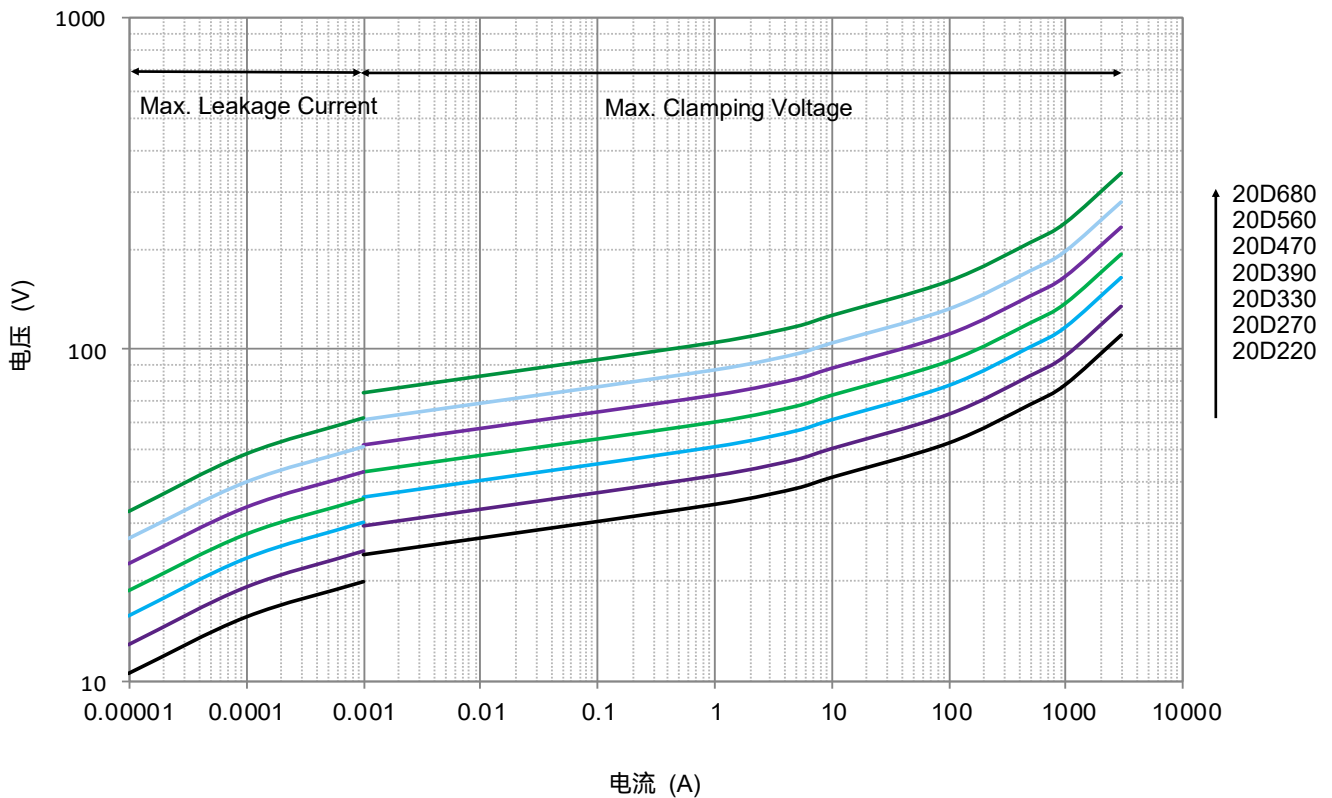

压敏电阻

Metal Oxide Varistor (MOV)

SFV20D 系列

● 伏安特性曲线

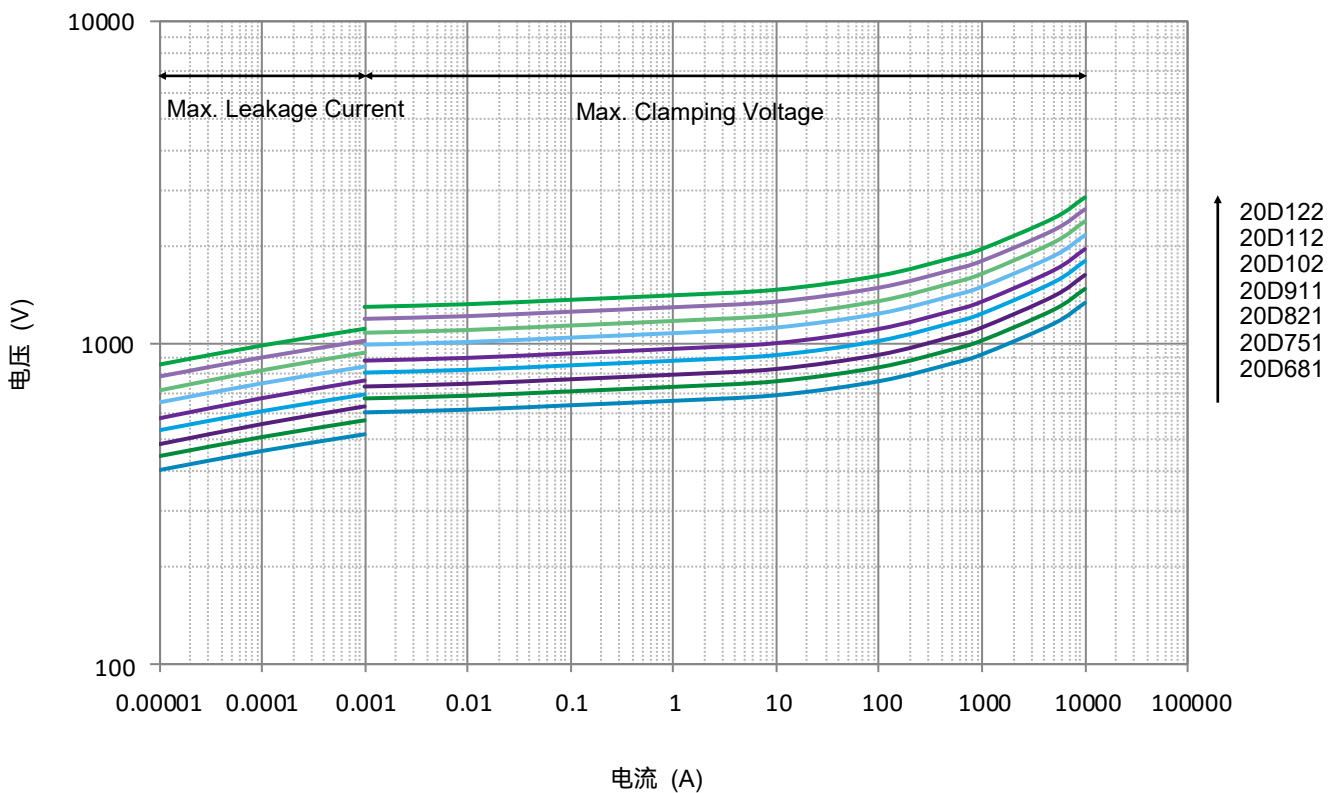
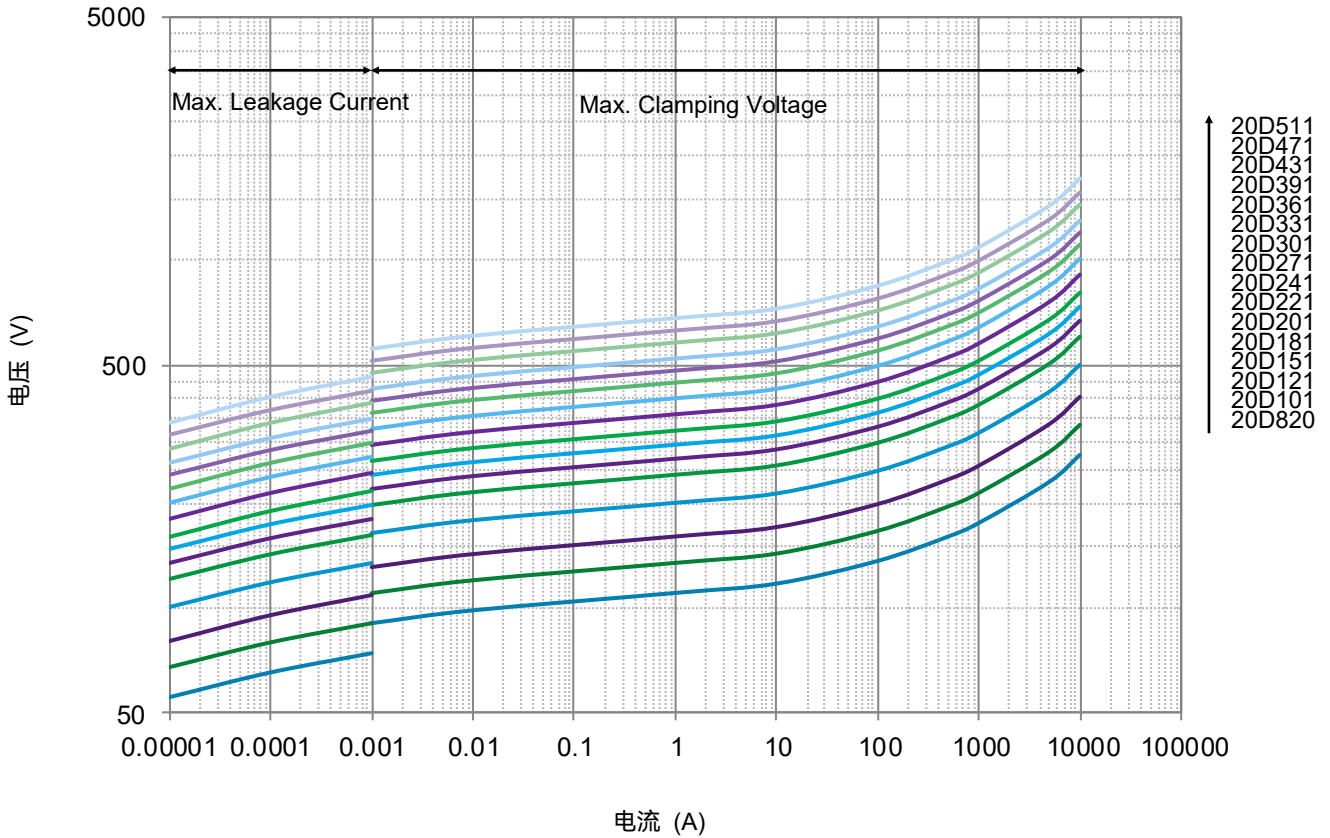

压敏电阻

Metal Oxide Varistor (MOV)

SFV20D 系列

包装

- 散装包装
- 散装包装数量和重量

系列	标称压敏电压 (V _N)	PE袋	数量/盒	数量/箱	毛重/箱 (365 × 265 × 245)
	(V)	(PCS)	(PCS)	(PCS)	(kg)±10%
SFV20D 系列	220 ~ 471	250	500	3000	8 ~ 18
	511 ~ 821	200	400	2400	16 ~ 23
	911 ~ 122	100	200	1200	12 ~ 13

备注：其他引脚长度的包装请咨询赛尔特。

单位 (mm)

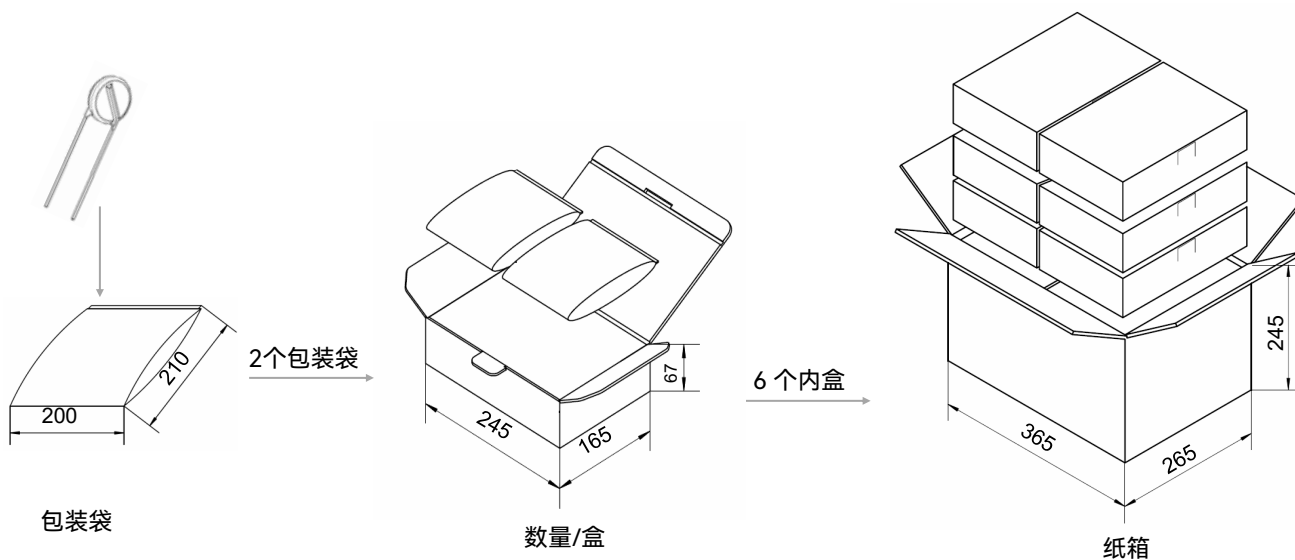

压敏电阻

Metal Oxide Varistor (MOV)

SFV20D 系列

包装

- 编带包装 (跨孔)

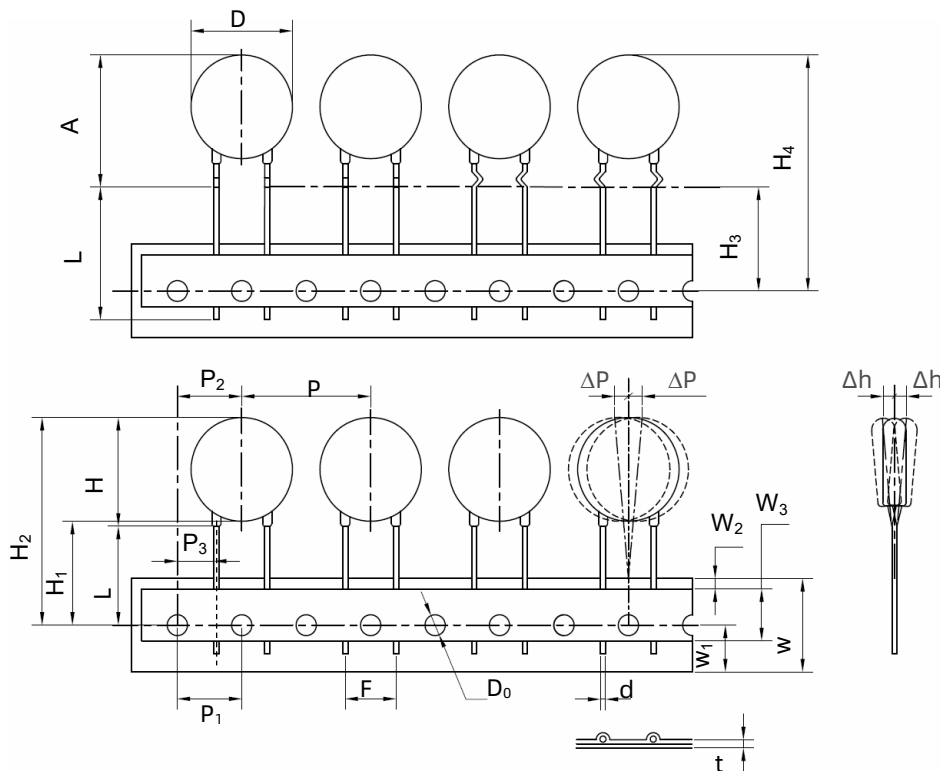

尺寸 (mm)	
P	25.4±1.0
P ₁	12.7±0.3
P ₂	12.7±1.3
P ₃	7.7±0.7
ΔP(max.)	1.0
W	18.0±1.0
W ₁	9.0±1.0
W ₂ (max.)	3.0
W ₃	10.0±2.0
H(max.)	25.5
H ₁	18.0
H ₂ (max.)	45.0 ^{+2.0} ₋₀
H ₃	18.0
H ₄ (max.)	48.0 ^{+2.0} ₋₀
Δh(max.)	2.0
t(max.)	0.6
D(max.)	23.0
D ₀	4.0±0.2
d	1.00±0.05
A(max.)	27.5
F	10.0±1.0
L(min.)	编带

- 编带包装数量和重量

系列	标称压敏电压 (V _N)	数量/盒	数量/箱	毛重/箱 (365 × 265 × 415)
20D	(V)	(PCS)	(PCS)	(kg)±10%
	102 ~ 122	250	1500	18 ~ 22
	751 ~ 911	300	1800	17 ~ 20
	621 ~ 681	350	2100	17 ~ 18
	471 ~ 561	400	2400	16 ~ 17
	391 ~ 431	450	2700	15 ~ 16
	680			16
	301 ~ 361	500	3000	15 ~ 16
	560			15
	221 ~ 271	550	3300	13 ~ 15
	151			15
	390 ~ 470			13 ~ 15
	181 ~ 201	600	3600	13 ~ 14
	820 ~ 121			11 ~ 14
220 ~ 330	11 ~ 14			

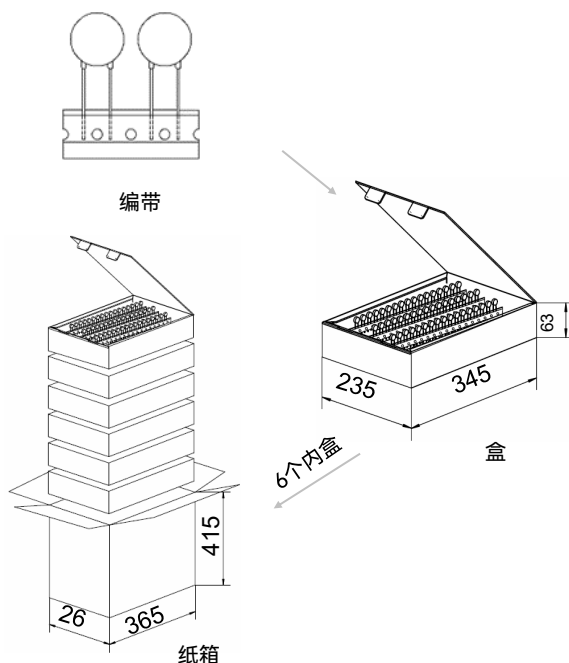

压敏电阻

Metal Oxide Varistor (MOV)

SFV20D 系列

包装

- 编带包装 (跨孔)

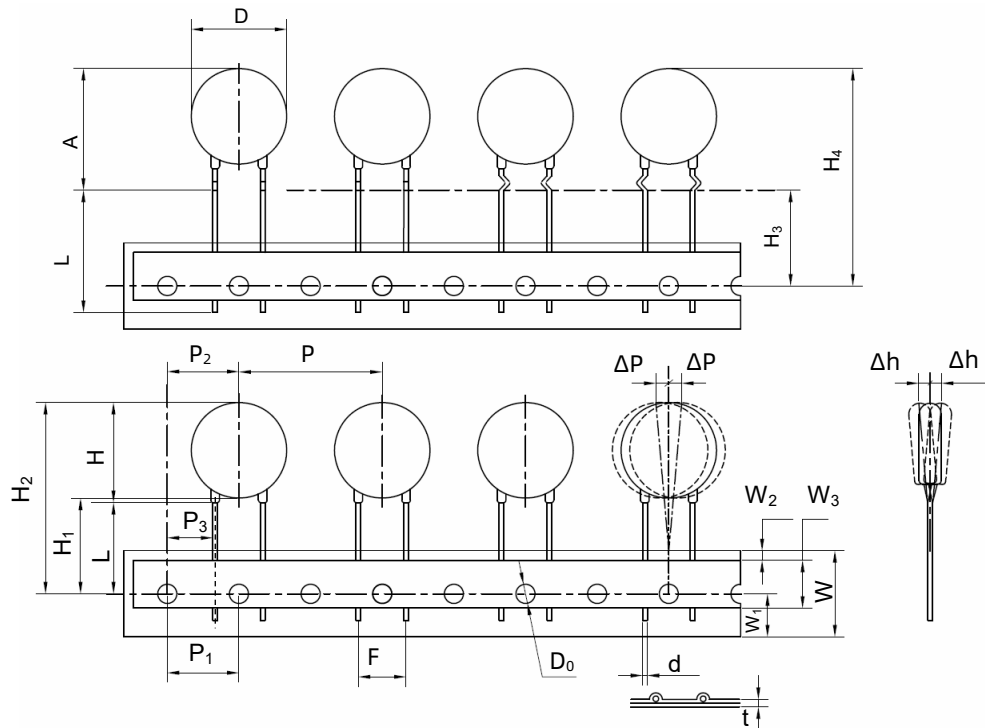

尺寸 (mm)	
P	30.0±1.0
P ₁	15.0±0.3
P ₂	15.0±1.3
P ₃	10.0±1.0
ΔP(max.)	1.0
W	18.0±1.0
W ₁	9.0±1.0
W ₂ (max.)	3.0
W ₃	10.0±2.0
H(max.)	25.5
H ₁	18.0
H ₂ (max.)	45.0 ^{+2.0} ₋₀
H ₃	18.0
H ₄ (max.)	48.0 ^{+2.0} ₋₀
Δh(max.)	2.0
t(max.)	0.6
D(max.)	23.0
D ₀	4.0±0.2
d	1.00±0.05
A(max.)	27.5
F	10.0±0.5
L(min.)	编带

- 编带包装数量和重量

系列	标称压敏电压 (V _N)	数量/盒	数量/箱	毛重/箱 G. W / Carton
20D	(V)	(PCS)	(PCS)	(kg)±10%
	102 ~ 122	200	1200	14 ~ 16
	251 ~ 911	250	1500	14 ~ 16
	561 ~ 681	300	1800	13 ~ 15
	431 ~ 511	350	2100	13 ~ 14
	331 ~ 391	400	2400	12 ~ 13
	560 ~ 680			
	241 ~ 301	450	2700	11 ~ 12
	390 ~ 470			
	181 ~ 221	500	3000	10 ~ 12
	820 ~ 121			10 ~ 11
	220 ~ 330			9 ~ 11

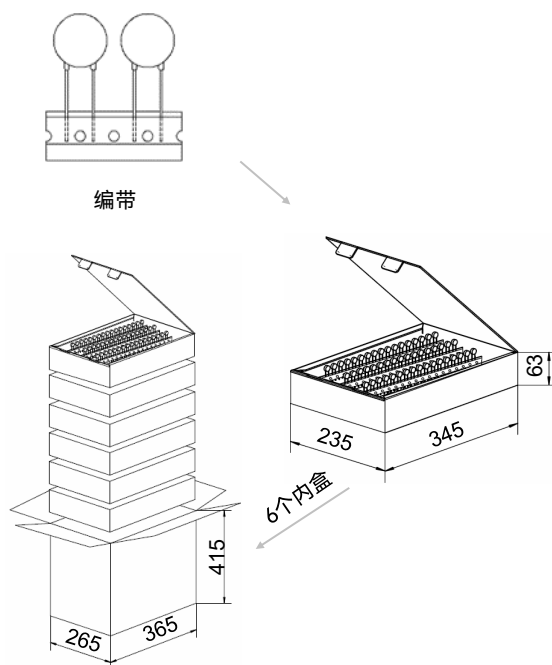

压敏电阻

Metal Oxide Varistor (MOV)

SFV20D 系列

安装

机械应力

安装时应避免敲击压敏电阻，以免造成机械损伤。

焊接参数

波峰焊参数

本波峰焊参数仅供参考，实际使用时应做相关的试验进行验证。

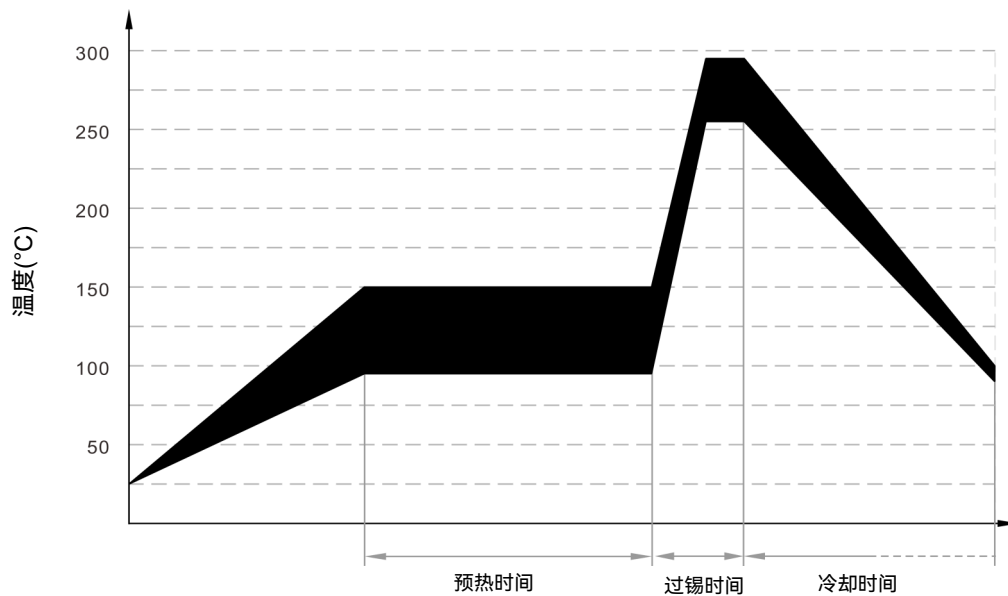

波峰焊曲线

项目	温度 (°C)	时间 (s)
预热	90 ~ 150	<150
过锡	255 ~ 290	3 ~ 10

手工焊参数

项目	条件
烙铁头部温度	350 °C (max.)
焊接时间	4 s (max.)

压敏电阻

Metal Oxide Varistor (MOV)

SFV20D 系列

术语

项目	描述
V_N	标准压敏电压 在规定持续时间的脉冲电流下测得MOV两端的电压。 — (GB 18802.331) — (IEC 61051-1)
I_L	漏电流 在25°C或规定的其它温度下, 施加最大直流电压时, 通过压敏电阻器中的电流。 — (GB/T 10193) — (IEC 61051-1)
UCT	上限类别温度 压敏电阻器设计所确定的能够连续工作的最高环境温度。 — (GB/T 10193) — (IEC 61051-1)
LCT	下限类别温度 压敏电阻器设计所确定的能够连续工作的最低环境温度。 — (GB/T 10193) — (IEC 61051-1)
Max. Peak Current	最大峰值电流 在环境温度25°C时, 对于规定的脉冲次数而言, 压敏电阻器中允许通过的每个脉冲的最大电流值。 — (GB/T 10193) — (IEC 61051-1)
V_C	箝制电压 规定脉冲峰值电流及规定波形下测得MOV两端的电压峰值。 — (GB 18802.331) — (IEC 61051-1)
Voltage Proof	耐电压 连续可施加在压敏电阻器引出端和导电性安装之间的最大峰值电压。 — (GB/T 10193) — (IEC 61051-1)
C_V	电容量 MOV两端之间的电容量, 其测量应在规定的正弦频率和电压以及规定的温度下进行。除非另有规定, 推荐采用25°C下, 1 V r.m.s., 1 kHz的信号。 — (GB 18802.331) — (IEC 61051-1)
V_{ac}	最大连续交流电压 在环境温度25°C时, 可以施加在元件上连续工作的、波形基本是正弦波 (总谐波畸变小于5%) 的最大交流电压有效值。当温度高于25°C时, 详细规范应给出降额曲线。 — (GB/T 10193) — (IEC 61051-1)
V_{dc}	最大连续直流电压 在环境温度25°C时, 可以施加在元件上连续工作的最大直流电压 (波纹小于5%)。当温度高于25°C时, 详细规范应给出降额曲线。 — (GB/T 10193) — (IEC 61051-1)

压敏电阻

Metal Oxide Varistor (MOV)

SFV20D 系列



注意

使用

1. 压敏电阻的使用环境温度不能超出技术条件规定的范围。
2. 请不要用酮类、酯类、苯类、卤代烃等强极性溶剂清洗本产品，以免破坏产品的封装层。
3. 请不要强烈的振动、冲击或施加压力，以免压敏电阻表面树脂或元件产生裂痕。
4. 对引线进行弯曲加工或切断加工时，请固定元件端引线。折弯距离引线绝缘覆盖部分至少2 mm。

更换

如发现压敏电阻外观有损伤，请更换。

贮存

1. 存储温度：(-40 to +125) °C。
2. 相对湿度：≤75% RH。
3. 海拔高度：<2000 m。
4. 压敏电阻的存储应避免高温、高湿、阳光直射和腐蚀性气体的场合，以免影响引脚的可焊性，产品出厂后请于1年内使用。

不适宜环境条件

1. 压敏电阻不应直接暴露在露天工作。
2. 压敏电阻应避免在雨水，水蒸汽等高温高湿的条件下工作。
3. 压敏电阻应避免在沙尘、盐雾、有害气体的条件下工作。

压敏电阻的固有电容

压敏电阻的固有电容最大参考值已在规格表中列出，供设计师在高频电路中选择时参考。

压敏电阻 (MOV) 特性与型号概览

AC	DC	0.5	1	1.75	2	3	3.5	6	10	20	70	最大连续工作电压 U_n (V)		
												AC	DC	
480V	500V	○	○	○	○	○	SFV10D122K(T)	SFV14D122K(T)	SFV20D122K(T)	SFV25D122K(T)	SFV53D122K	750	990	
		○	○	○	○	○	SFV10D112K(T)	SFV14D112K(T)	SFV20D112K(T)	SFV25D112K(T)	SFV53D112K	680	895	
		○	○	○	○	○	SFV10D102K(T)	SFV14D102K(T)	SFV20D102K(T)	SFV25D102K(T)	SFV53D102K	625	825	
		○	○	○	○	○	SFV10D911K(T)	SFV14D911K(T)	SFV20D911K(T)	SFV25D911K(T)	SFV53D911K	550	745	
		○	○	SFV7D821K(T)	○	○	SFV10D821K(T)	SFV14D821K(T)	SFV20D821K(T)	SFV25D821K(T)	SFV53D821K	510	670	
		○	○	SFV7D751K(T)	○	○	SFV10D751K(T)	SFV14D751K(T)	SFV20D751K(T)	SFV25D751K(T)	SFV53D751K	460	615	
	380V	240V	○	○	SFV7D681K(T)	○	○	SFV10D681K(T)	SFV14D681K(T)	SFV20D681K(T)	SFV25D681K(T)	SFV53D681K	420	560
			○	○	SFV7D621K(T)	○	○	SFV10D621K(T)	SFV14D621K(T)	SFV20D621K(T)	SFV25D621K(T)	SFV53D621K	385	505
			○	○	SFV7D561K(T)	○	○	SFV10D561K(T)	SFV14D561K(T)	SFV20D561K(T)	SFV25D561K(T)	SFV53D561K	350	460
			○	○	SFV7D511K(T)	○	○	SFV10D511K(T)	SFV14D511K(T)	SFV20D511K(T)	SFV25D511K(T)	SFV53D511K	320	415
			○	○	SFV7D471K(T)	○	○	SFV10D471K(T)	SFV14D471K(T)	SFV20D471K(T)	SFV25D471K(T)	SFV53D471K	300	385
			○	○	SFV7D431K(T)	○	○	SFV10D431K(T)	SFV14D431K(T)	SFV20D431K(T)	SFV25D431K(T)	SFV53D431K	275	350
100V	250V	○	○	SFV7D391K(T)	○	○	SFV10D391K(T)	SFV14D391K(T)	SFV20D391K(T)	SFV25D391K(T)	SFV53D391K	250	320	
		○	○	SFV7D361K(T)	○	○	SFV10D361K(T)	SFV14D361K(T)	SFV20D361K(T)	SFV25D361K(T)	SFV53D361K	230	300	
		○	○	SFV7D331K(T)	○	○	SFV10D331K(T)	SFV14D331K(T)	SFV20D331K(T)	SFV25D331K(T)	SFV53D331K	210	275	
		○	○	SFV7D301K(T)	○	○	SFV10D301K(T)	SFV14D301K(T)	SFV20D301K(T)	SFV25D301K(T)	SFV53D301K	190	250	
		○	○	SFV7D271K(T)	○	○	SFV10D271K(T)	SFV14D271K(T)	SFV20D271K(T)	SFV25D271K(T)	SFV53D271K	175	225	
		○	○	SFV7D241K(T)	○	○	SFV10D241K(T)	SFV14D241K(T)	SFV20D241K(T)	SFV25D241K(T)	SFV53D241K	150	200	
100V	120V	○	○	SFV7D221K(T)	○	○	SFV10D221K(T)	SFV14D221K(T)	SFV20D221K(T)	SFV25D221K(T)	SFV53D221K	140	180	
		○	○	SFV7D201K(T)	○	○	SFV10D201K(T)	SFV14D201K(T)	SFV20D201K(T)	SFV25D201K(T)	SFV53D201K	130	170	
		○	○	SFV7D181K(T)	○	○	SFV10D181K(T)	SFV14D181K(T)	SFV20D181K(T)	SFV25D181K(T)	SFV53D181K	115	150	
		○	○	SFV7D151K(T)	○	○	SFV10D151K(T)	SFV14D151K(T)	SFV20D151K(T)	SFV25D151K(T)	SFV53D151K	95	125	
		○	○	SFV7D121K(T)	○	○	SFV10D121K(T)	SFV14D121K(T)	SFV20D121K(T)	SFV25D121K(T)	SFV53D121K	75	100	
		○	○	SFV7D101K(T)	○	○	SFV10D101K(T)	SFV14D101K(T)	SFV20D101K(T)	SFV25D101K(T)	SFV53D101K	60	85	
48V	12V	○	○	SFV7D820K(T)	○	○	SFV10D820K(T)	SFV14D820K(T)	SFV20D820K(T)	SFV25D820K(T)	SFV53D820K	50	65	
		○	○	SFV7D680K(T)	SFV10D680K(T)	○	SFV14D680K(T)	SFV20D680K(T)	○	SFV25D680K(T)	○	○	40	56
		○	○	SFV7D560K(T)	SFV10D560K(T)	○	SFV14D560K(T)	SFV20D560K(T)	○	SFV25D560K(T)	○	○	35	45
		○	○	SFV7D470K(T)	SFV10D470K(T)	○	SFV14D470K(T)	SFV20D470K(T)	○	SFV25D470K(T)	○	○	30	38
		○	○	SFV7D390K(T)	SFV10D390K(T)	○	SFV14D390K(T)	SFV20D390K(T)	○	SFV25D390K(T)	○	○	25	31
		○	○	SFV7D330K(T)	SFV10D330K(T)	○	SFV14D330K(T)	SFV20D330K(T)	○	SFV25D330K(T)	○	○	20	26
24V	12V	○	○	SFV7D270K(T)	SFV10D270K(T)	○	SFV14D270K(T)	SFV20D270K(T)	○	SFV25D270K(T)	○	○	17	22
		○	○	SFV7D220K(T)	SFV10D220K(T)	○	SFV14D220K(T)	SFV20D220K(T)	○	SFV25D220K(T)	○	○	14	18

型号

最大峰值电流 (8/20 μs) (kA)

压敏电阻 (MOV) 特性与型号概览

额定工作电压 U_n (V)	AC	DC	型号				最大连续工作电压 U_n (V)		
			1.75	3.5	6	10	20	AC	DC
500V	480V			SFV10D122KM	SFV14D122KM	SFV20D122KM	SFV25D122KM	750	990
				SFV10D112KM	SFV14D112KM	SFV20D112KM	SFV25D112KM	680	895
	415V			SFV10D102KM	SFV14D102KM	SFV20D102KM	SFV25D102KM	625	825
				SFV10D911KM	SFV14D911KM	SFV20D911KM	SFV25D911KM	550	745
380V			SFV7D821KM	SFV10D821KM	SFV14D821KM	SFV20D821KM	SFV25D821KM	510	670
			SFV7D751KM	SFV10D751KM	SFV14D751KM	SFV20D751KM	SFV25D751KM	460	615
100V			SFV7D681KM	SFV10D681KM	SFV14D681KM	SFV20D681KM	SFV25D681KM	420	560
			SFV7D621KM	SFV10D621KM	SFV14D621KM	SFV20D621KM	SFV25D621KM	385	505
240V			SFV7D561KM	SFV10D561KM	SFV14D561KM	SFV20D561KM	SFV25D561KM	350	460
			SFV7D511KM	SFV10D511KM	SFV14D511KM	SFV20D511KM	SFV25D511KM	320	415
100V			SFV7D471KM	SFV10D471KM	SFV14D471KM	SFV20D471KM	SFV25D471KM	300	385
	220V		SFV7D431KM	SFV10D431KM	SFV14D431KM	SFV20D431KM	SFV25D431KM	275	350
250V			SFV7D391KM	SFV10D391KM	SFV14D391KM	SFV20D391KM	SFV25D391KM	250	320
			SFV7D361KM	SFV10D361KM	SFV14D361KM	SFV20D361KM	SFV25D361KM	230	300
			SFV7D331KM	SFV10D331KM	SFV14D331KM	SFV20D331KM	SFV25D331KM	210	275
	120V		SFV7D301KM	SFV10D301KM	SFV14D301KM	SFV20D301KM	SFV25D301KM	190	250
125V			SFV7D271KM	SFV10D271KM	SFV14D271KM	SFV20D271KM	SFV25D271KM	175	225
			SFV7D241KM	SFV10D241KM	SFV14D241KM	SFV20D241KM	SFV25D241KM	150	200
			SFV7D221KM	SFV10D221KM	SFV14D221KM	SFV20D221KM	SFV25D221KM	140	180
			SFV7D201KM	SFV10D201KM	SFV14D201KM	SFV20D201KM	SFV25D201KM	130	170
48V			SFV7D181KM	SFV10D181KM	SFV14D181KM	SFV20D181KM	SFV25D181KM	115	150
			SFV7D151KM	SFV10D151KM	SFV14D151KM	SFV20D151KM	SFV25D151KM	95	125
			SFV7D121KM	SFV10D121KM	SFV14D121KM	SFV20D121KM	SFV25D121KM	75	100
			SFV7D101KM	SFV10D101KM	SFV14D101KM	SFV20D101KM	SFV25D101KM	60	85
24V			SFV7D820KM	SFV10D820KM	SFV14D820KM	SFV20D820KM	SFV25D820KM	50	65
					SFV25D680KM			40	56
					SFV25D560KM			35	45
					SFV25D470KM			30	38
12V								25	31
								20	26
								17	22
								14	18

最大峰值电流 (8/20 μ s) (kA)

压敏电阻 (MOV) 特性与型号概览

额定工作电压 U_n (V)		型号										最大连续工作电压 U_n (V)		
AC	DC	2	3	5	6	8	10	15	20	25	40	AC	DC	
480V	500V							SFV20S122K		SFV25S122K	SFV34S122K	750	990	
								SFV20S112K		SFV25S112K	SFV34S112K	680	895	
								SFV20S102K		SFV25S102K	SFV34S102K	625	825	
								SFV20S911K		SFV25S911K	SFV34S911K	550	745	
								SFV20S821K		SFV25S821K	SFV34S821K	510	670	
	415V				SFV10S821K			SFV15S821K	SFV20S821K		SFV25S821K	SFV34S821K	460	615
					SFV10S751K			SFV15S751K	SFV20S751K		SFV25S751K	SFV34S751K	420	560
					SFV10S681K			SFV15S681K	SFV20S681K		SFV25S681K	SFV34S681K	385	505
					SFV10S621K			SFV15S621K	SFV20S621K		SFV25S621K	SFV34S621K	350	460
					SFV10S561K			SFV15S561K	SFV20S561K		SFV25S561K	SFV34S561K	320	415
380V	250V							SFV15S511K	SFV20S511K		SFV25S511K	SFV34S511K	300	385
								SFV15S471K	SFV20S471K		SFV25S471K	SFV34S471K	275	350
								SFV15S431K	SFV20S431K		SFV25S431K	SFV34S431K	250	320
								SFV15S391K	SFV20S391K		SFV25S391K	SFV34S391K	230	300
								SFV15S361K	SFV20S361K		SFV25S361K	SFV34S361K	210	275
	100V				SFV10S331K			SFV15S331K	SFV20S331K		SFV25S331K	SFV34S331K	190	250
					SFV10S301K			SFV15S301K	SFV20S301K		SFV25S301K	SFV34S301K	175	225
					SFV10S271K			SFV15S271K	SFV20S271K		SFV25S271K	SFV34S271K	150	200
					SFV10S241K			SFV15S241K	SFV20S241K		SFV25S241K	SFV34S241K	140	180
					SFV10S221K			SFV15S221K	SFV20S221K		SFV25S221K	SFV34S221K	130	170
240V	125V							SFV15S201K	SFV20S201K		SFV25S201K	SFV34S201K	115	150
								SFV15S181K	SFV20S181K		SFV25S181K	SFV34S181K	95	125
								SFV15S151K	SFV20S151K		SFV25S151K	SFV34S151K	75	100
					SFV10S121K			SFV15S121K	SFV20S121K		SFV25S121K	SFV34S121K	60	85
					SFV10S101K			SFV15S101K	SFV20S101K		SFV25S101K	SFV34S101K	50	65
	100V				SFV10S820K			SFV15S820K	SFV20S820K		SFV25S820K	SFV34S820K	40	56
			24V	SFV10S680K	SFV15S680K	SFV20S680K			SFV25S680K		SFV34S680K		35	45
				SFV10S560K	SFV15S560K	SFV20S560K			SFV25S560K		SFV34S560K		30	38
				SFV10S470K	SFV15S470K	SFV20S470K		SFV25S470K			SFV34S470K		25	31
				SFV10S390K	SFV15S390K SFV20S390K			SFV25S390K					20	26
100V	12V			SFV10S330K			SFV25S330K					17	22	
				SFV10S270K	SFV15S270K SFV20S270K		SFV25S270K					14	18	
				SFV10S220K	SFV15S220K SFV20S220K SFV25S220K									

最大峰值电流 (8/20 μ s) (kA)

X-ON Electronics

Largest Supplier of Electrical and Electronic Components

Click to view similar products for [Varistors](#) category:

Click to view products by [SETfuse](#) manufacturer:

Other Similar products are found below :

[R71ZOV151HC](#) [B72205S271K111](#) [B72214S251K151](#) [NTE1V020](#) [NTE1V130](#) [25FN511K](#) [S10K11G5S5](#) [ERZ-C14DK361U](#) [ERZ-C20DK221U](#) [207869-1](#) [AS-13](#) [B72540E 350K 62](#) [B72590D360A60](#) [B72650M301K93](#) [B72670M1140K72](#) [TVZ18EC271KBS](#) [TVZ20EB911KBS](#) [TVZ25D201KBS](#) [TVZ25D241KBS](#) [VDRH20X230BSE](#) [VZ07D220KBS](#) [VZ40D241KQ-N](#) [VZ40D241K](#) [VZ25D511KBS-N](#) [VZ20E511KBSX](#) [VZ20E221KBSX](#) [VZ10D471KBS-N](#) [20A9FN241K](#) [B72650M350K72](#) [TVZ25D301KBS](#) [TVZ20EC911KBS](#) [TVZ20EBN911KBS](#) [TVZ18EC471KBS](#) [B72220S350K101](#) [NTE1V030](#) [NTE1V275](#) [NTE2V015](#) [NTE2V035](#) [NTE2V115](#) [VZ20D391KBS-N](#) [VZ10D241KBS-N](#) [VZ07D390KBS-N](#) [VDRH14V060TSE](#) [VDRH20X300BKE](#) [V300LT4PX1841](#) [NTE1V017](#) [NTE1V115](#) [NTE1V150](#) [NTE1V300](#) [NTE2V025](#)