



# SGM2036

## 300mA, Low Power, Low Dropout, RF Linear Regulators

### GENERAL DESCRIPTION

The SGM2036 series low-power, low-dropout, CMOS linear voltage regulators operate from a 1.6V to 5.5V input voltage and deliver up to 300mA output current. They are the perfect choice for low voltage, low power applications. A low ground current makes this part attractive for battery operated power systems. The SGM2036 series also offer low dropout voltage to prolong battery life in portable electronics. Systems requiring a quiet voltage source, such as RF applications, will benefit from the SGM2036 series' low output noise and high PSRR.

Other features include a 10nA logic-controlled shutdown mode, short current limit and thermal shutdown protection.

The SGM2036 has auto-discharge function to quickly discharge  $V_{OUT}$  in the disable status.

The SGM2036 is available in Green UTDFN-1×1-4L, SOT-23-5 and SC70-5 packages. It operates over an ambient temperature range of -40°C to +85°C.

### FEATURES

- Low Dropout Voltage
- Thermal Overload Protection
- Built-In Fold Back Protection Circuit
- 20 $\mu$ A Low Supply Current
- 10nA Logic-Controlled Shutdown
- 1.6V to 5.5V Input Voltage Range
- Fixed Outputs of 0.8V, 0.9V, 1.0V, 1.05V, 1.1V, 1.2V, 1.3V, 1.35V, 1.5V, 1.8V, 1.85V, 2.1V, 2.2V, 2.3V, 2.5V, 2.6V, 2.7V, 2.8V, 2.85V, 2.9V, 3.0V, 3.1V, 3.3V, 3.6V, 4.2V, 4.4V and 5.0V
- Adjustable Output from 0.8V to 5.0V
- Short Auto-Discharge Function
- 300mA Output Current
- High Output Voltage Accuracy
- Quick Start-Up Time
- -40°C to +85°C Operating Temperature Range
- Available in Green UTDFN-1×1-4L, SOT-23-5 and SC70-5 Packages

### APPLICATIONS

Cellular Telephones  
Cordless Telephones  
PCMCIA Cards  
Modems  
MP3 Player  
Hand-Held Instruments  
Palmtop Computers  
Electronic Planners  
Portable/Battery-Powered Equipment

## PACKAGE/ORDERING INFORMATION

MODEL	V <sub>OUT</sub> (V)	PACKAGE DESCRIPTION	ORDERING NUMBER	PACKAGE MARKING	PACKING OPTION
SGM2036-0.8	0.8	UTDFN-1×1-4L	SGM2036-0.8YUDH4G/TR	SF	Tape and Reel, 10000
SGM2036-0.9	0.9	UTDFN-1×1-4L	SGM2036-0.9YUDH4G/TR	NE	Tape and Reel, 10000
SGM2036-1.0	1.0	UTDFN-1×1-4L	SGM2036-1.0YUDH4G/TR	J3	Tape and Reel, 10000
SGM2036-1.05	1.05	UTDFN-1×1-4L	SGM2036-1.05YUDH4G/TR	NF	Tape and Reel, 10000
SGM2036-1.1	1.1	UTDFN-1×1-4L	SGM2036-1.1YUDH4G/TR	O0	Tape and Reel, 10000
SGM2036-1.2	1.2	UTDFN-1×1-4L	SGM2036-1.2YUDH4G/TR	HE	Tape and Reel, 10000
SGM2036-1.3	1.3	UTDFN-1×1-4L	SGM2036-1.3YUDH4G/TR	O1	Tape and Reel, 10000
SGM2036-1.35	1.35	UTDFN-1×1-4L	SGM2036-1.35YUDH4G/TR	Z7	Tape and Reel, 10000
SGM2036-1.5	1.5	UTDFN-1×1-4L	SGM2036-1.5YUDH4G/TR	HF	Tape and Reel, 10000
SGM2036-1.8	1.8	UTDFN-1×1-4L	SGM2036-1.8YUDH4G/TR	I0	Tape and Reel, 10000
SGM2036-1.85	1.85	UTDFN-1×1-4L	SGM2036-1.85YUDH4G/TR	O2	Tape and Reel, 10000
SGM2036-2.1	2.1	UTDFN-1×1-4L	SGM2036-2.1YUDH4G/TR	O3	Tape and Reel, 10000
SGM2036-2.2	2.2	UTDFN-1×1-4L	SGM2036-2.2YUDH4G/TR	O4	Tape and Reel, 10000
SGM2036-2.3	2.3	UTDFN-1×1-4L	SGM2036-2.3YUDH4G/TR	SA	Tape and Reel, 10000
SGM2036-2.5	2.5	UTDFN-1×1-4L	SGM2036-2.5YUDH4G/TR	O5	Tape and Reel, 10000
SGM2036-2.6	2.6	UTDFN-1×1-4L	SGM2036-2.6YUDH4G/TR	N6	Tape and Reel, 10000
SGM2036-2.7	2.7	UTDFN-1×1-4L	SGM2036-2.7YUDH4G/TR	O6	Tape and Reel, 10000
SGM2036-2.8	2.8	UTDFN-1×1-4L	SGM2036-2.8YUDH4G/TR	I1	Tape and Reel, 10000
SGM2036-2.85	2.85	UTDFN-1×1-4L	SGM2036-2.85YUDH4G/TR	O7	Tape and Reel, 10000
SGM2036-2.9	2.9	UTDFN-1×1-4L	SGM2036-2.9YUDH4G/TR	O8	Tape and Reel, 10000
SGM2036-3.0	3.0	UTDFN-1×1-4L	SGM2036-3.0YUDH4G/TR	I2	Tape and Reel, 10000
SGM2036-3.3	3.3	UTDFN-1×1-4L	SGM2036-3.3YUDH4G/TR	I3	Tape and Reel, 10000
SGM2036-0.8	0.8	SOT-23-5	SGM2036-0.8YN5G/TR	SS7XX	Tape and Reel, 3000
SGM2036-0.9	0.9	SOT-23-5	SGM2036-0.9YN5G/TR	SP0XX	Tape and Reel, 3000
SGM2036-1.0	1.0	SOT-23-5	SGM2036-1.0YN5G/TR	SP1XX	Tape and Reel, 3000
SGM2036-1.05	1.05	SOT-23-5	SGM2036-1.05YN5G/TR	SP2XX	Tape and Reel, 3000
SGM2036-1.1	1.1	SOT-23-5	SGM2036-1.1YN5G/TR	SP3XX	Tape and Reel, 3000
SGM2036-1.2	1.2	SOT-23-5	SGM2036-1.2YN5G/TR	SP4XX	Tape and Reel, 3000
SGM2036-1.3	1.3	SOT-23-5	SGM2036-1.3YN5G/TR	SP5XX	Tape and Reel, 3000
SGM2036-1.5	1.5	SOT-23-5	SGM2036-1.5YN5G/TR	SP6XX	Tape and Reel, 3000
SGM2036-1.8	1.8	SOT-23-5	SGM2036-1.8YN5G/TR	SP7XX	Tape and Reel, 3000
SGM2036-1.85	1.85	SOT-23-5	SGM2036-1.85YN5G/TR	SP8XX	Tape and Reel, 3000
SGM2036-2.1	2.1	SOT-23-5	SGM2036-2.1YN5G/TR	SP9XX	Tape and Reel, 3000
SGM2036-2.2	2.2	SOT-23-5	SGM2036-2.2YN5G/TR	SPAXX	Tape and Reel, 3000
SGM2036-2.3	2.3	SOT-23-5	SGM2036-2.3YN5G/TR	SS9XX	Tape and Reel, 3000
SGM2036-2.5	2.5	SOT-23-5	SGM2036-2.5YN5G/TR	SPBXX	Tape and Reel, 3000
SGM2036-2.6	2.6	SOT-23-5	SGM2036-2.6YN5G/TR	SN5XX	Tape and Reel, 3000
SGM2036-2.7	2.7	SOT-23-5	SGM2036-2.7YN5G/TR	SPCXX	Tape and Reel, 3000
SGM2036-2.8	2.8	SOT-23-5	SGM2036-2.8YN5G/TR	SPDXX	Tape and Reel, 3000
SGM2036-2.85	2.85	SOT-23-5	SGM2036-2.85YN5G/TR	SPEXX	Tape and Reel, 3000
SGM2036-2.9	2.9	SOT-23-5	SGM2036-2.9YN5G/TR	SPFXX	Tape and Reel, 3000

## PACKAGE/ORDERING INFORMATION (continued)

MODEL	V <sub>OUT</sub> (V)	PACKAGE DESCRIPTION	ORDERING NUMBER	PACKAGE MARKING	PACKING OPTION
SGM2036-3.0	3.0	SOT-23-5	SGM2036-3.0YN5G/TR	SQ0XX	Tape and Reel, 3000
SGM2036-3.1	3.1	SOT-23-5	SGM2036-3.1YN5G/TR	SQ1XX	Tape and Reel, 3000
SGM2036-3.3	3.3	SOT-23-5	SGM2036-3.3YN5G/TR	SQ2XX	Tape and Reel, 3000
SGM2036-3.6	3.6	SOT-23-5	SGM2036-3.6YN5G/TR	SQ3XX	Tape and Reel, 3000
SGM2036-4.2	4.2	SOT-23-5	SGM2036-4.2YN5G/TR	SQ4XX	Tape and Reel, 3000
SGM2036-4.4	4.4	SOT-23-5	SGM2036-4.4YN5G/TR	SQ5XX	Tape and Reel, 3000
SGM2036-5.0	5.0	SOT-23-5	SGM2036-5.0YN5G/TR	SQ6XX	Tape and Reel, 3000
SGM2036-ADJ	Adjustable	SOT-23-5	SGM2036-ADJYN5G/TR	SQ7XX	Tape and Reel, 3000
SGM2036-0.8	0.8	SC70-5	SGM2036-0.8YC5G/TR	SSBXX	Tape and Reel, 3000
SGM2036-0.9	0.9	SC70-5	SGM2036-0.9YC5G/TR	SQ8XX	Tape and Reel, 3000
SGM2036-1.0	1.0	SC70-5	SGM2036-1.0YC5G/TR	SQ9XX	Tape and Reel, 3000
SGM2036-1.05	1.05	SC70-5	SGM2036-1.05YC5G/TR	SQAXX	Tape and Reel, 3000
SGM2036-1.1	1.1	SC70-5	SGM2036-1.1YC5G/TR	SQBXX	Tape and Reel, 3000
SGM2036-1.2	1.2	SC70-5	SGM2036-1.2YC5G/TR	SQCXX	Tape and Reel, 3000
SGM2036-1.3	1.3	SC70-5	SGM2036-1.3YC5G/TR	SQDXX	Tape and Reel, 3000
SGM2036-1.5	1.5	SC70-5	SGM2036-1.5YC5G/TR	SQEXX	Tape and Reel, 3000
SGM2036-1.8	1.8	SC70-5	SGM2036-1.8YC5G/TR	SQFXX	Tape and Reel, 3000
SGM2036-1.85	1.85	SC70-5	SGM2036-1.85YC5G/TR	SR0XX	Tape and Reel, 3000
SGM2036-2.1	2.1	SC70-5	SGM2036-2.1YC5G/TR	SR1XX	Tape and Reel, 3000
SGM2036-2.2	2.2	SC70-5	SGM2036-2.2YC5G/TR	SR2XX	Tape and Reel, 3000
SGM2036-2.3	2.3	SC70-5	SGM2036-2.3YC5G/TR	SS8XX	Tape and Reel, 3000
SGM2036-2.5	2.5	SC70-5	SGM2036-2.5YC5G/TR	SR3XX	Tape and Reel, 3000
SGM2036-2.6	2.6	SC70-5	SGM2036-2.6YC5G/TR	SN4XX	Tape and Reel, 3000
SGM2036-2.7	2.7	SC70-5	SGM2036-2.7YC5G/TR	SR4XX	Tape and Reel, 3000
SGM2036-2.8	2.8	SC70-5	SGM2036-2.8YC5G/TR	SR5XX	Tape and Reel, 3000
SGM2036-2.85	2.85	SC70-5	SGM2036-2.85YC5G/TR	SR6XX	Tape and Reel, 3000
SGM2036-2.9	2.9	SC70-5	SGM2036-2.9YC5G/TR	SR7XX	Tape and Reel, 3000
SGM2036-3.0	3.0	SC70-5	SGM2036-3.0YC5G/TR	SR8XX	Tape and Reel, 3000
SGM2036-3.1	3.1	SC70-5	SGM2036-3.1YC5G/TR	SR9XX	Tape and Reel, 3000
SGM2036-3.3	3.3	SC70-5	SGM2036-3.3YC5G/TR	SRAXX	Tape and Reel, 3000
SGM2036-3.6	3.6	SC70-5	SGM2036-3.6YC5G/TR	SRBXX	Tape and Reel, 3000
SGM2036-4.2	4.2	SC70-5	SGM2036-4.2YC5G/TR	SRCXX	Tape and Reel, 3000
SGM2036-4.4	4.4	SC70-5	SGM2036-4.4YC5G/TR	SRDXX	Tape and Reel, 3000
SGM2036-5.0	5.0	SC70-5	SGM2036-5.0YC5G/TR	SREXX	Tape and Reel, 3000
SGM2036-ADJ	Adjustable	SC70-5	SGM2036-ADJYC5G/TR	SRFXX	Tape and Reel, 3000

## NOTE:

1. XX = Date Code.

Green (RoHS & HSF): SG Micro Corp defines "Green" to mean Pb-Free (RoHS compatible) and free of halogen substances. If you have additional comments or questions, please contact your SGMICRO representative directly.

## MARKING INFORMATION

SYY X X

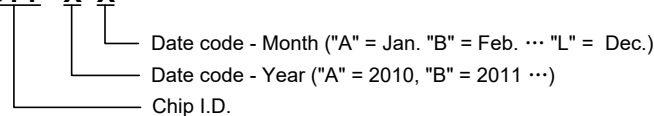

For example: SRFFA (2015, January)

**ABSOLUTE MAXIMUM RATINGS**

IN to GND .....	-0.3V to 6V
Output Short-Circuit Duration.....	Infinite
EN to GND.....	-0.3V to 6V
OUT, BP/FB to GND .....	-0.3V to (V <sub>IN</sub> + 0.3V)
Power Dissipation, P <sub>D</sub> @ T <sub>A</sub> = +25°C	
UTDFN-1×1-4L .....	400mW
SOT-23-5.....	390mW
SC70-5.....	340mW
Package Thermal Resistance	
UTDFN-1×1-4L, θ <sub>JA</sub> .....	280°C/W
SOT-23-5, θ <sub>JA</sub> .....	285°C/W
SC70-5, θ <sub>JA</sub> .....	330°C/W
Junction Temperature .....	+150°C
Storage Temperature Range.....	-65°C to +150°C
Lead Temperature (Soldering, 10s) .....	+260°C
ESD Susceptibility	
HBM.....	4000V
MM.....	400V

**RECOMMENDED OPERATING CONDITIONS**

Operating Voltage Range.....	1.6V to 5.5V
Operating Temperature Range .....	-40°C to +85°C

**OVERSTRESS CAUTION**

Stresses beyond those listed may cause permanent damage to the device. Functional operation of the device at these or any other conditions beyond those indicated in the operational section of the specification is not implied. Exposure to absolute maximum rating conditions for extended periods may affect reliability.

**ESD SENSITIVITY CAUTION**

This integrated circuit can be damaged by ESD if you don't pay attention to ESD protection. SGMICRO recommends that all integrated circuits be handled with appropriate precautions. Failure to observe proper handling and installation procedures can cause damage. ESD damage can range from subtle performance degradation to complete device failure. Precision integrated circuits may be more susceptible to damage because very small parametric changes could cause the device not to meet its published specifications.

**DISCLAIMER**

SG Micro Corp reserves the right to make any change in circuit design, specification or other related things if necessary without notice at any time.

**PIN CONFIGURATIONS**

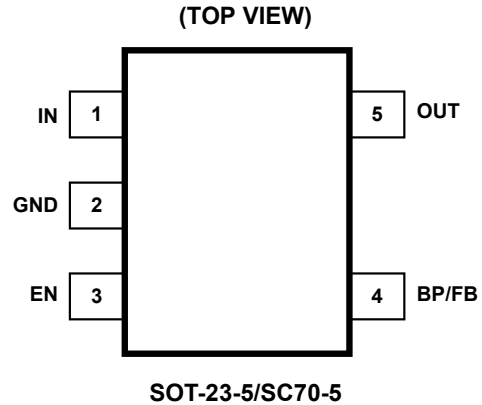
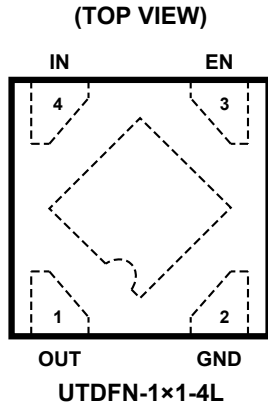

**PIN DESCRIPTION**

PIN		NAME	FUNCTION
UTDNF-1x1-4L	SOT-23-5/ SC70-5		
1	5	OUT	Regulator Output.
2	2	GND	Ground.
3	3	EN	Enable Pin. This pin has an internal pull-down resistor. A logic low reduces the supply current to less than 1µA. Connect to IN for normal operation.
4	1	IN	Regulator Input. Supply voltage can range from 1.6V to 5.5V. Bypass with a 1µF capacitor to GND.
-	4	BP	Reference-Noise Bypass Pin (fixed voltage version only). Bypass with a low-leakage 0.01µF ceramic capacitor for reduced noise at the output. The capacitor is recommended to be placed very close to the pin for high PSRR.
		FB	Feedback Pin (adjustable voltage version only). This is used to set the output voltage of the device.
Exposed Pad	-	-	The exposed pad should be connected to a large ground plane to maximize thermal performance.

## ELECTRICAL CHARACTERISTICS

(V<sub>IN</sub> = V<sub>OUT (NOMINAL)</sub> + 0.5V or 2.5V, whichever is greater, Full = -40°C to +85°C, unless otherwise noted.)

PARAMETER	SYMBOL	CONDITIONS	TEMP	MIN	TYP	MAX	UNITS	
Input Voltage	V <sub>IN</sub>		+25°C	1.6		5.5	V	
Output Voltage Accuracy		I <sub>OUT</sub> = 0.1mA	+25°C	-2.5		+2.5	%	
Feedback Voltage	V <sub>FB</sub>	I <sub>OUT</sub> = 0.1mA, SGM2036-ADJ	+25°C	0.78	0.8	0.82	V	
Maximum Output Current <sup>(1)</sup>			+25°C	300			mA	
Current Limit	I <sub>LIM</sub>		+25°C	360	560		mA	
Supply Pin Current	I <sub>Q</sub>	No Load, V <sub>EN</sub> = V <sub>IN</sub>	+25°C		20	26	μA	
Dropout Voltage <sup>(2)</sup>	V <sub>DROP</sub>	I <sub>OUT</sub> = 300mA	V <sub>OUT</sub> = 0.8V	+25°C		940	1200	mV
			V <sub>OUT</sub> = 0.9V	+25°C		840	1100	
			1.0V ≤ V <sub>OUT</sub> < 1.1V	+25°C		780	1000	
			1.1V ≤ V <sub>OUT</sub> < 1.2V	+25°C		680	900	
			1.2V ≤ V <sub>OUT</sub> < 1.5V	+25°C		590	800	
			1.5V ≤ V <sub>OUT</sub> < 1.8V	+25°C		420	550	
			1.8V ≤ V <sub>OUT</sub> < 2.1V	+25°C		320	420	
			2.1V ≤ V <sub>OUT</sub> < 2.5V	+25°C		260	340	
			2.5V ≤ V <sub>OUT</sub> < 3.0V	+25°C		215	280	
			3.0V ≤ V <sub>OUT</sub> < 3.6V	+25°C		190	250	
		3.6V ≤ V <sub>OUT</sub> ≤ 5.0V	+25°C		165	210		
Line Regulation	$\frac{\Delta V_{OUT}}{\Delta V_{IN} \times V_{OUT}}$	V <sub>IN</sub> = 1.6V or (V <sub>OUT</sub> + 0.5V) to 5.5V, I <sub>OUT</sub> = 1mA	1.8V ≤ V <sub>OUT</sub> ≤ 3.3V	+25°C		0.01	0.06	%V
			V <sub>OUT</sub> < 1.8V or V <sub>OUT</sub> > 3.3V	+25°C		0.01	0.1	
Load Regulation	ΔV <sub>OUT</sub>	I <sub>OUT</sub> = 0.1mA to 300mA	+25°C		12	40	mV	
		I <sub>OUT</sub> = 0.1mA to 300mA, SGM2036-ADJ	+25°C		0.5	10		
Short Current Limit	I <sub>SHORT</sub>	V <sub>OUT</sub> = 0V	+25°C		200		mA	
Power Supply Rejection Ratio	PSRR	C <sub>BP</sub> = 0μF, I <sub>OUT</sub> = 30mA, C <sub>OUT</sub> = 1μF, V <sub>IN</sub> = V <sub>OUT</sub> + 1V, ΔV <sub>RIPPLE</sub> = 0.2V <sub>P-P</sub>	f = 217Hz	+25°C		80	dB	
			f = 1kHz	+25°C		75		
			C <sub>BP</sub> = 0.01μF, I <sub>OUT</sub> = 30mA, C <sub>OUT</sub> = 1μF, V <sub>IN</sub> = V <sub>OUT</sub> + 1V, ΔV <sub>RIPPLE</sub> = 0.2V <sub>P-P</sub>	f = 217Hz	+25°C			82
			f = 1kHz	+25°C		70		
Output Voltage Noise	e <sub>n</sub>	C <sub>BP</sub> = 0μF, f = 10Hz to 100kHz, C <sub>OUT</sub> = 1μF, V <sub>OUT</sub> = 1.8V	I <sub>OUT</sub> = 0mA	+25°C		100	μV <sub>RMS</sub>	
			I <sub>OUT</sub> = 30mA	+25°C		200		
			C <sub>BP</sub> = 0.01μF, f = 10Hz to 100kHz, C <sub>OUT</sub> = 1μF, V <sub>OUT</sub> = 1.8V	I <sub>OUT</sub> = 0mA	+25°C			30
			I <sub>OUT</sub> = 30mA	+25°C		75		
Output Voltage Temperature Coefficient <sup>(3)</sup>	$\frac{\Delta V_{OUT}}{\Delta T_A \times V_{OUT}}$	I <sub>OUT</sub> = 0.1mA		Full		30	ppm/°C	
<b>SHUTDOWN</b>								
EN Input Threshold	V <sub>IH</sub>	V <sub>IN</sub> = 1.6V to 5.5V	Full		1.5		V	
	V <sub>IL</sub>		Full			0.4		
EN Input Bias Current	I <sub>BH</sub>	V <sub>EN</sub> = 5.5V	Full		0.8	2	μA	
	I <sub>BL</sub>	V <sub>EN</sub> = 0V	Full		0.01	1		
Shutdown Supply Current	I <sub>SHDN</sub>	V <sub>EN</sub> = 0V	Full		0.01	1	μA	
Start-Up Time <sup>(4)</sup>	t <sub>STR</sub>	C <sub>OUT</sub> = 1μF, No Load	+25°C		30		μs	
R <sub>ON</sub> of Discharge MOSFET		V <sub>IN</sub> = 4.0V, V <sub>EN</sub> = 0V	+25°C		50		Ω	

**ELECTRICAL CHARACTERISTICS (continued)**

( $V_{IN} = V_{OUT(NOMINAL)} + 0.5V$  or  $2.5V$ , whichever is greater, Full =  $-40^{\circ}C$  to  $+85^{\circ}C$ , unless otherwise noted.)

PARAMETER	SYMBOL	CONDITIONS	TEMP	MIN	TYP	MAX	UNITS
<b>THERMAL PROTECTION</b>							
Thermal Shutdown Temperature	$T_{SHDN}$				140		$^{\circ}C$
Thermal Shutdown Hysteresis	$\Delta T_{SHDN}$				15		$^{\circ}C$

**NOTES:**

1. Maximum output current is affected by the PCB layout, size of metal trace, the thermal conduction path between metal layers, ambient temperature and the other environment factors of system. Attention should be paid to the dropout voltage when  $V_{IN} < V_{OUT} + V_{DROP}$ .
2. The dropout voltage is defined as  $V_{IN} - V_{OUT}$ , when  $V_{OUT}$  is 100mV below the value of  $V_{OUT}$  for  $V_{IN} = V_{OUT} + 0.5V$  or  $2.5V$ .
3. Output voltage temperature coefficient is defined as the worst-case voltage change divided by the total temperature range.
4. Time needed for  $V_{OUT}$  to reach 90% of final value.

**BLOCK DIAGRAM**

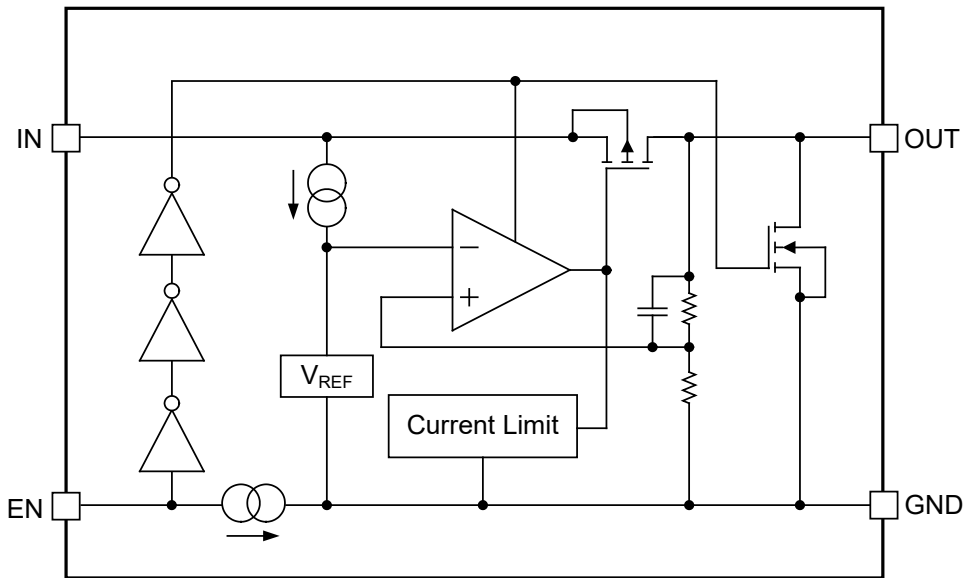

TYPICAL APPLICATION CIRCUITS

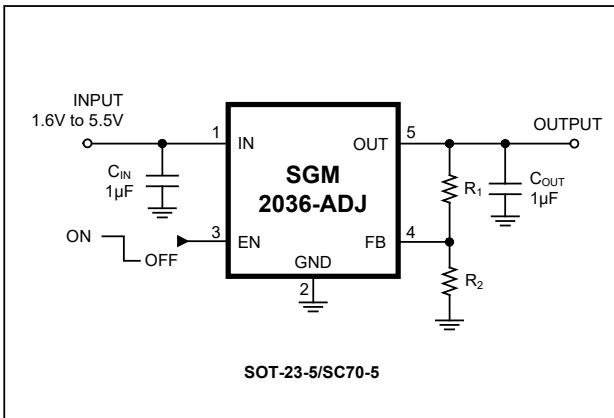
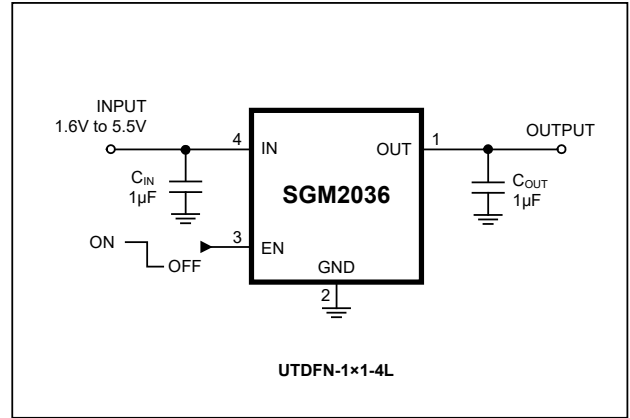
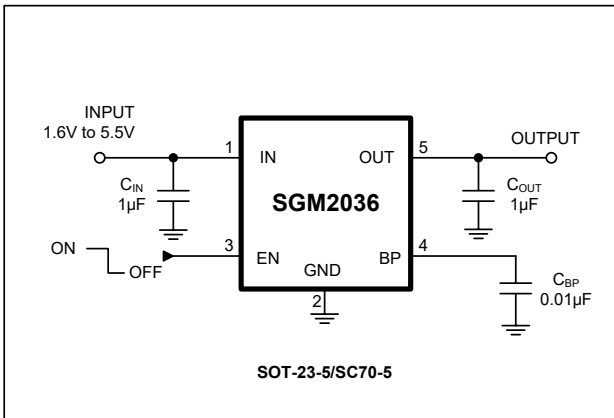

NOTE: Choose  $R_2 = 160k\Omega$  to maintain a  $5\mu A$  minimum load.  
 Calculate the value for  $R_1$  using the following equation:

$$R_1 = R_2 \times \left( \frac{V_{OUT}}{0.8V} - 1 \right)$$



TYPICAL PERFORMANCE CHARACTERISTICS

$V_{EN} = V_{IN}$ ,  $C_{IN} = 1\mu F$ ,  $C_{OUT} = 1\mu F$ ,  $C_{BP} = 0\mu F$ ,  $T_A = +25^\circ C$ , unless otherwise noted.

Turn On Speed with EN Pin

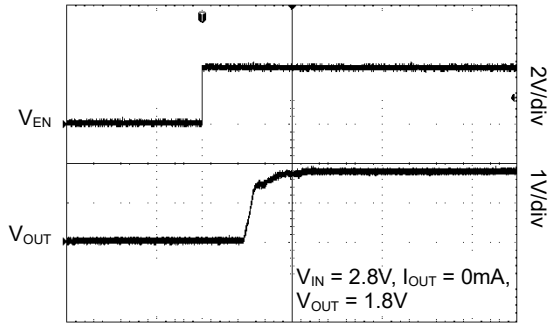

Time (20µs/div)

Turn On Speed with EN Pin

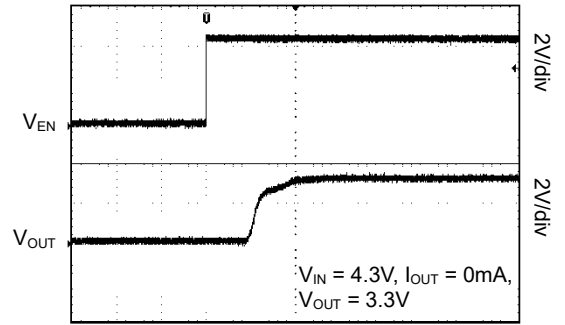

Time (20µs/div)

Turn Off Speed with EN Pin

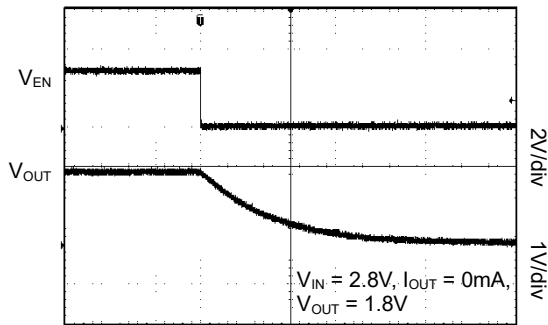

Time (40µs/div)

Turn Off Speed with EN Pin

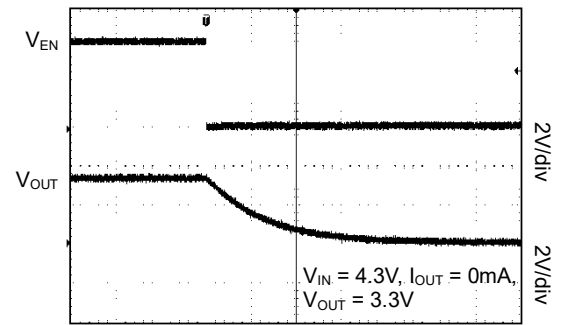

Time (40µs/div)

Line Transient Response

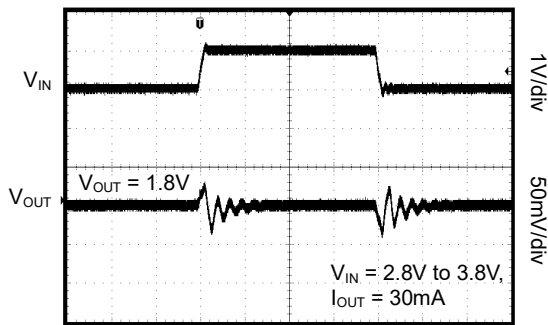

Time (40µs/div)

Line Transient Response

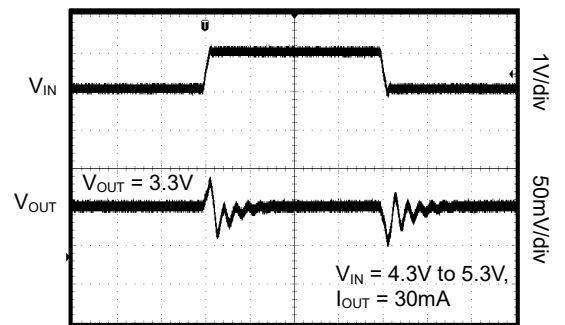

Time (40µs/div)

TYPICAL PERFORMANCE CHARACTERISTICS (continued)

$V_{EN} = V_{IN}$ ,  $C_{IN} = 1\mu F$ ,  $C_{OUT} = 1\mu F$ ,  $C_{BP} = 0\mu F$ ,  $T_A = +25^\circ C$ , unless otherwise noted.

Load Transient Response

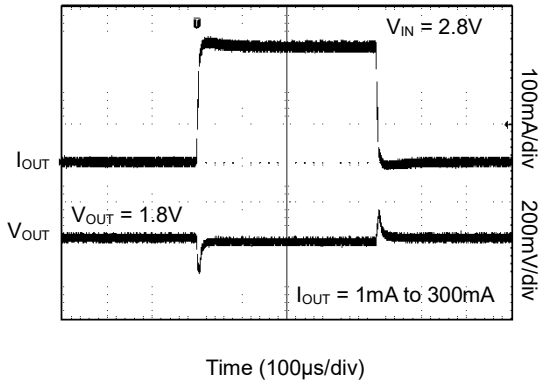

Load Transient Response

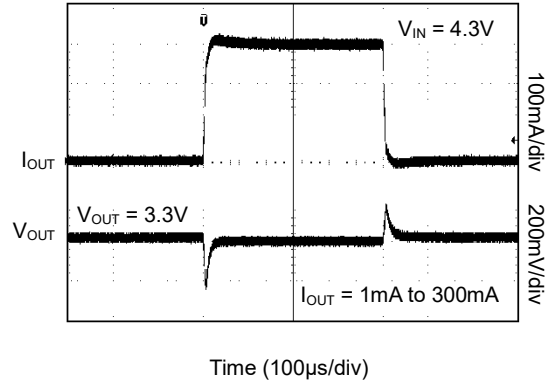

Load Transient Response

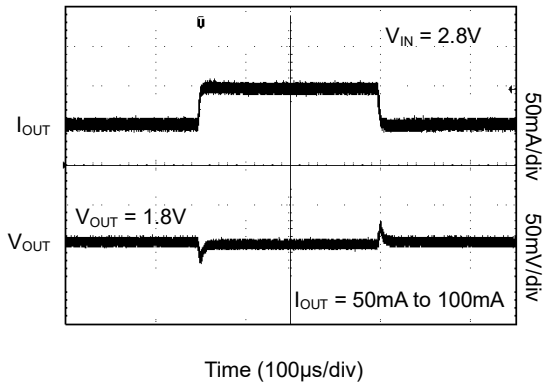

Load Transient Response

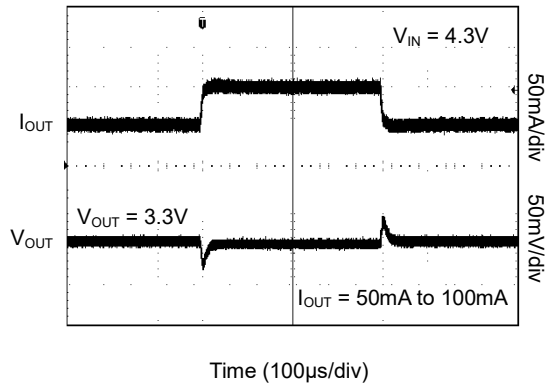

Power Supply Rejection Ratio vs. Frequency

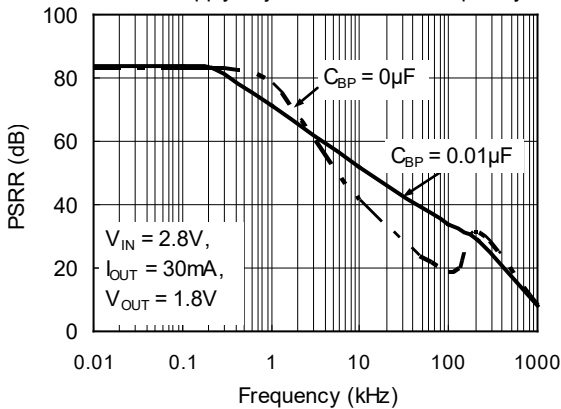

Power Supply Rejection Ratio vs. Frequency

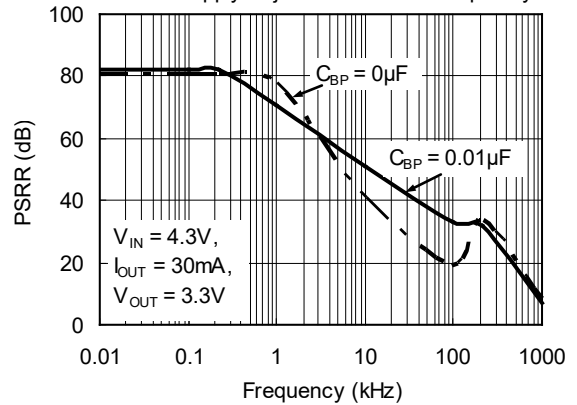

TYPICAL PERFORMANCE CHARACTERISTICS (continued)

$V_{EN} = V_{IN}$ ,  $C_{IN} = 1\mu F$ ,  $C_{OUT} = 1\mu F$ ,  $C_{BP} = 0\mu F$ ,  $T_A = +25^\circ C$ , unless otherwise noted.

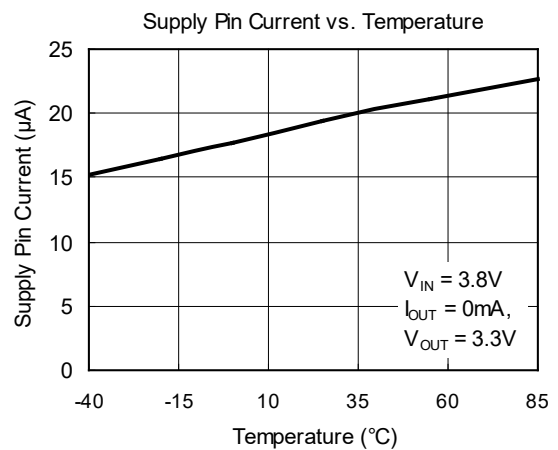
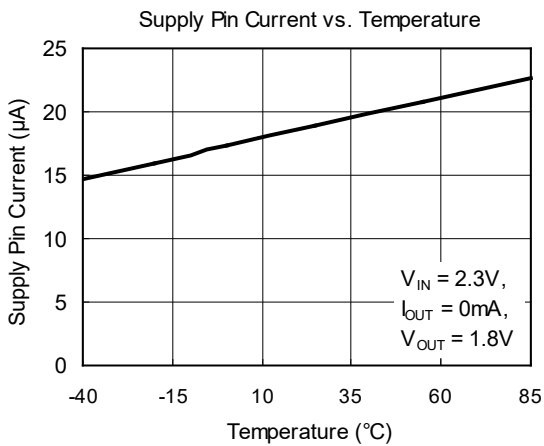
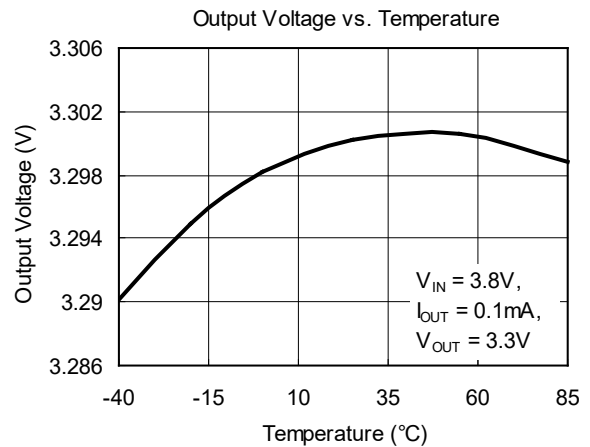
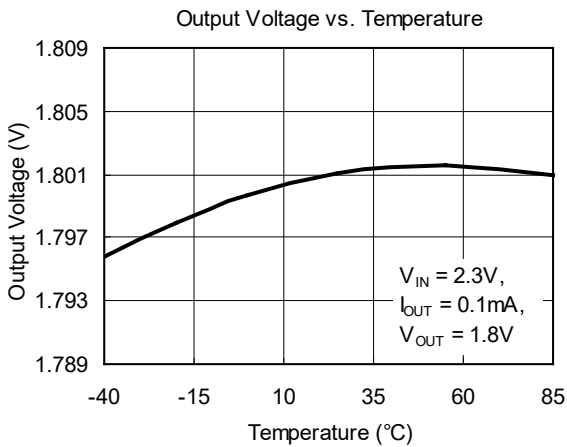
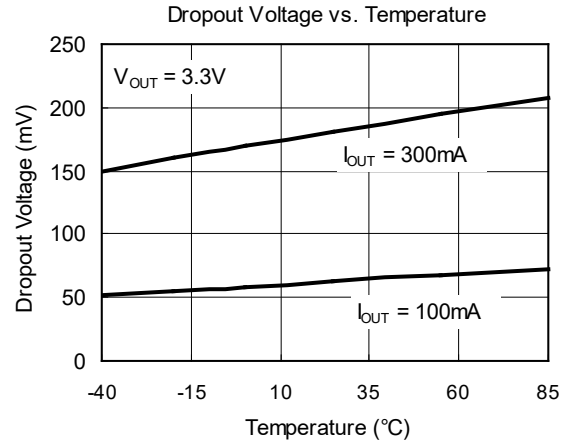
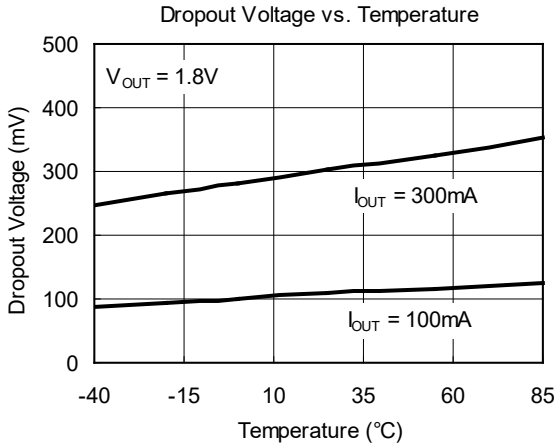

TYPICAL PERFORMANCE CHARACTERISTICS (continued)

$V_{EN} = V_{IN}$ ,  $C_{IN} = 1\mu F$ ,  $C_{OUT} = 1\mu F$ ,  $C_{BP} = 0\mu F$ ,  $T_A = +25^\circ C$ , unless otherwise noted.

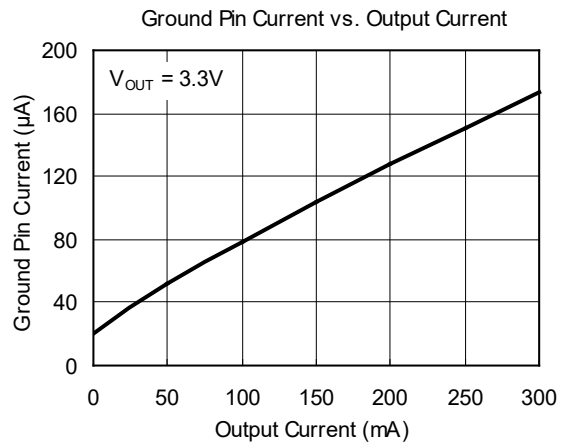
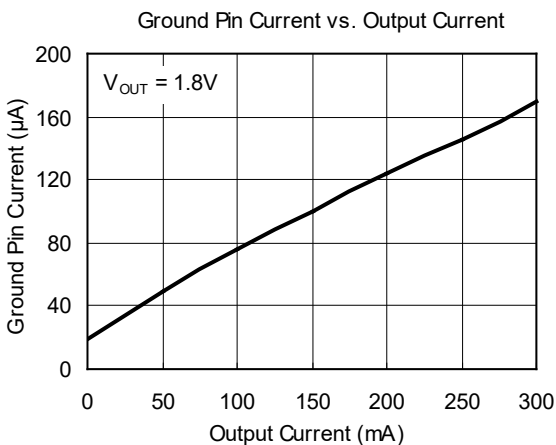
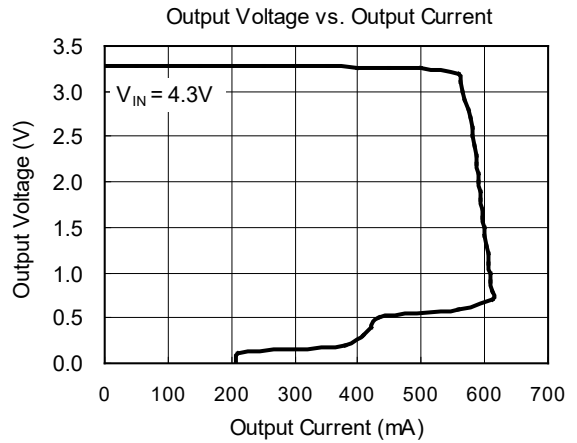
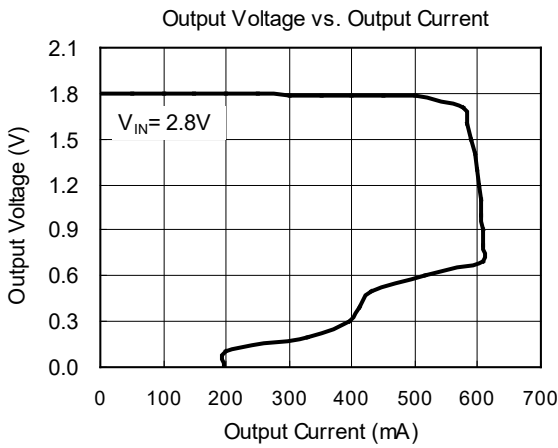
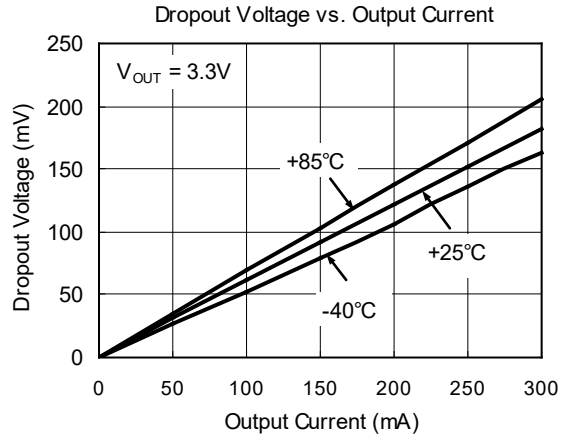
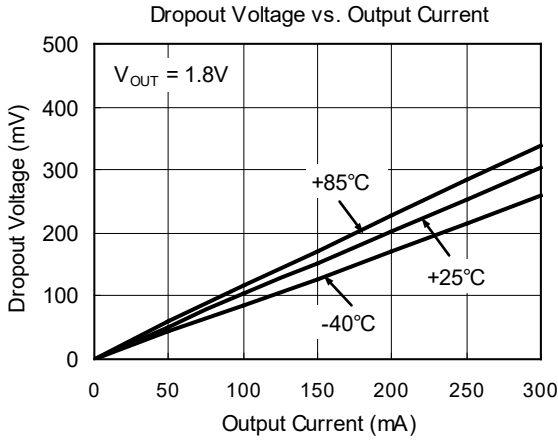

TYPICAL PERFORMANCE CHARACTERISTICS (continued)

$V_{EN} = V_{IN}$ ,  $C_{IN} = 1\mu F$ ,  $C_{OUT} = 1\mu F$ ,  $C_{BP} = 0\mu F$ ,  $T_A = +25^\circ C$ , unless otherwise noted.

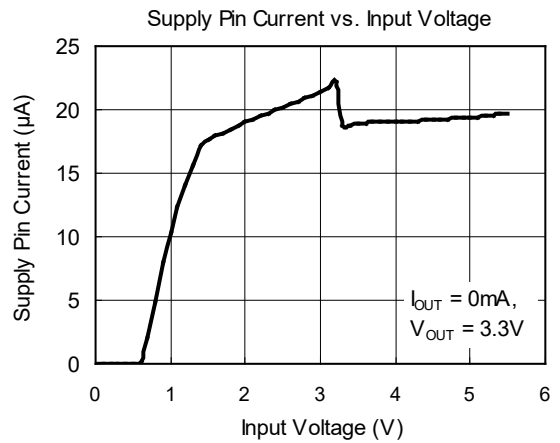
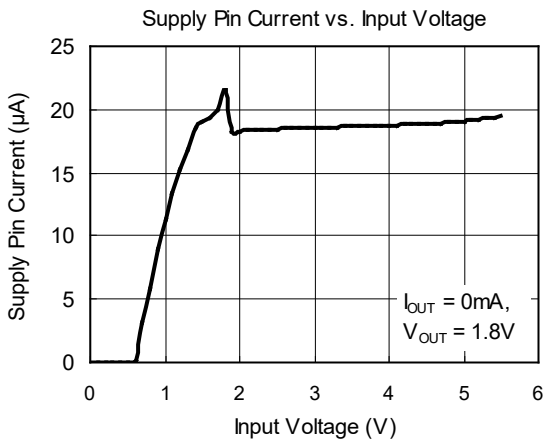
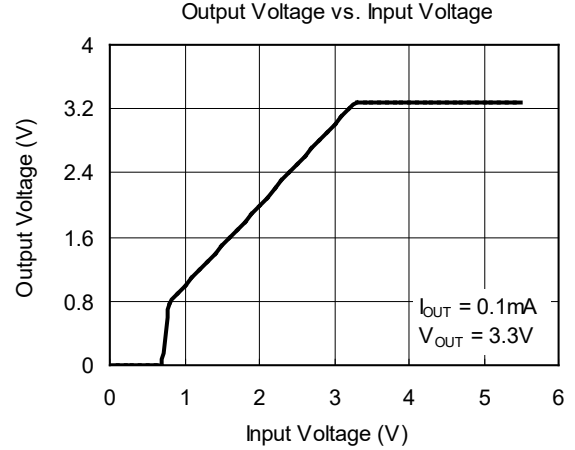
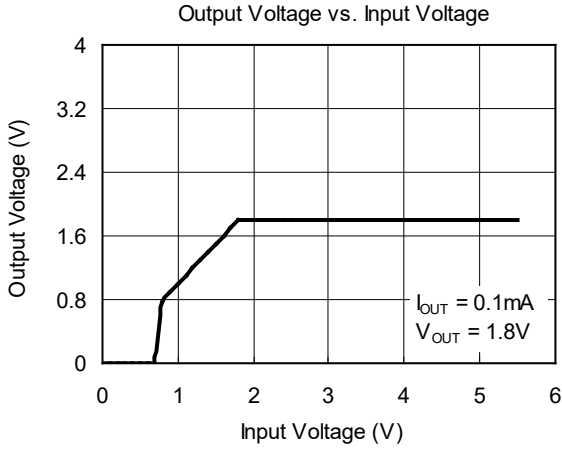

APPLICATION NOTE

When LDO is used in handheld products, attention must be paid to voltage spikes which could damage SGM2036. In such applications, voltage spikes will be generated at charger interface and  $V_{BUS}$  pin of USB interface when charger adapters and USB equipments are hot-plugged. Besides this, handheld products will be tested on the production line without battery. Test engineer will apply power from the connector pin which connects with positive pole of the battery. When external power supply is turned on suddenly, the voltage spikes will be generated at the battery connector. The voltage spikes will be very high, and it always exceeds the absolute maximum input voltage (6.0V) of LDO. In order to get robust design, design engineer needs to clear up this voltage spike. Zener diode is a cheap and effective solution to eliminate such voltage spike. For example, BZM55B5V6 is a 5.6V small package Zener diode which can be used to remove voltage spikes in cell phone designs. The schematic is shown below.

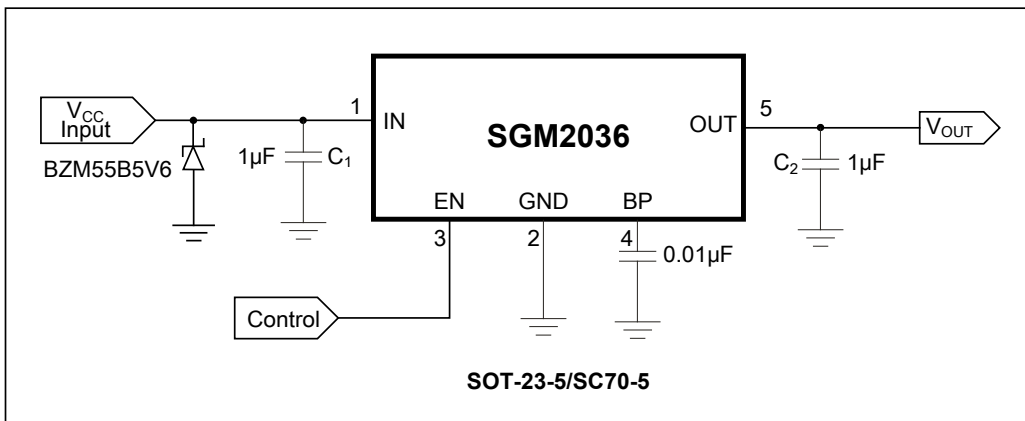
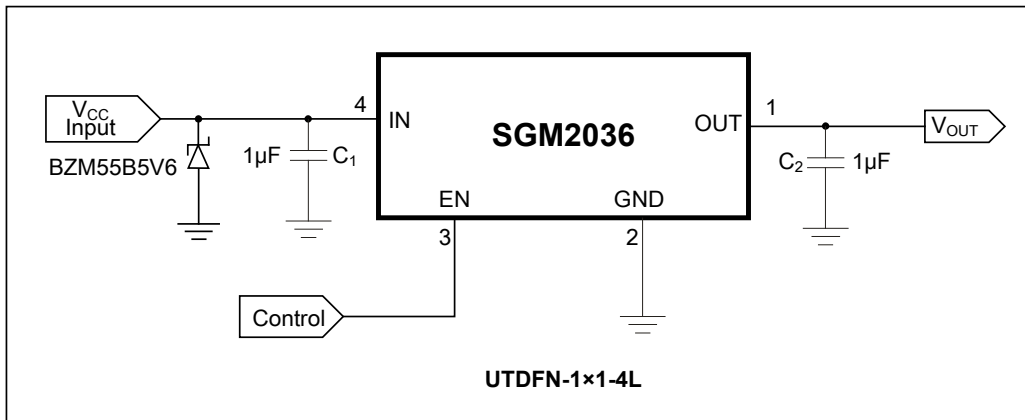

PACKAGE OUTLINE DIMENSIONS

SC70-5

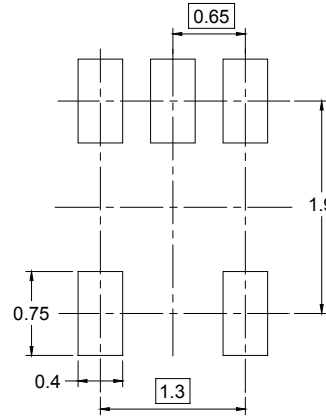
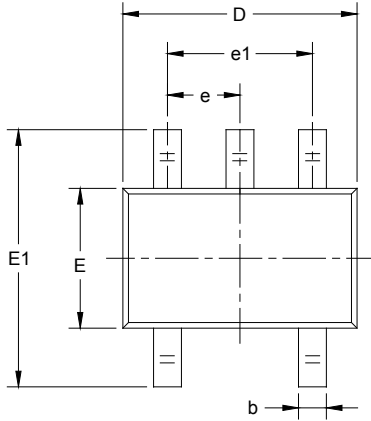

RECOMMENDED LAND PATTERN (Unit: mm)

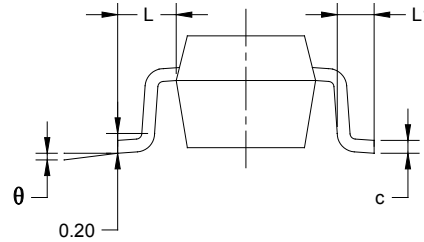
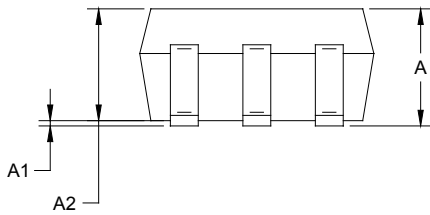

Symbol	Dimensions In Millimeters		Dimensions In Inches	
	MIN	MAX	MIN	MAX
A	0.900	1.100	0.035	0.043
A1	0.000	0.100	0.000	0.004
A2	0.900	1.000	0.035	0.039
b	0.150	0.350	0.006	0.014
c	0.080	0.150	0.003	0.006
D	2.000	2.200	0.079	0.087
E	1.150	1.350	0.045	0.053
E1	2.150	2.450	0.085	0.096
e	0.65 TYP		0.026 TYP	
e1	1.300 BSC		0.051 BSC	
L	0.525 REF		0.021 REF	
L1	0.260	0.460	0.010	0.018
$\theta$	0°	8°	0°	8°

PACKAGE OUTLINE DIMENSIONS

SOT-23-5

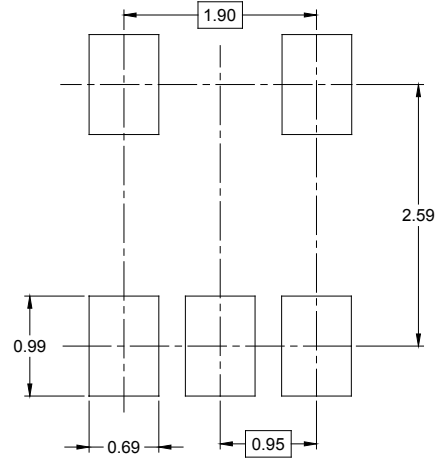
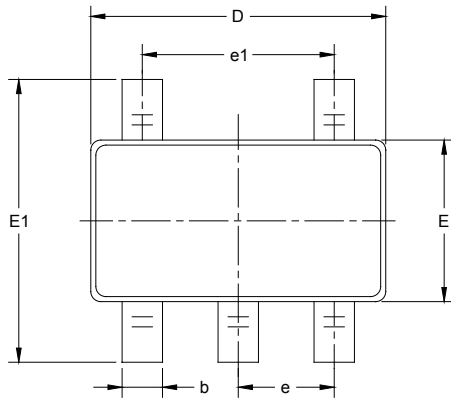

RECOMMENDED LAND PATTERN (Unit: mm)

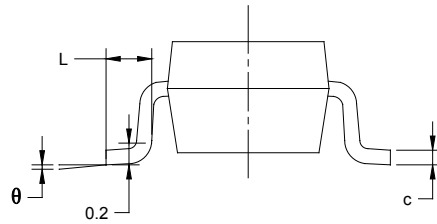
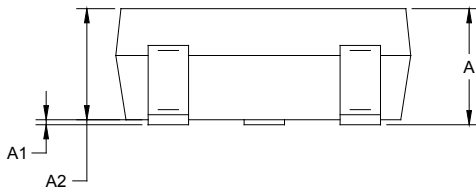

Symbol	Dimensions In Millimeters		Dimensions In Inches	
	MIN	MAX	MIN	MAX
A	1.050	1.250	0.041	0.049
A1	0.000	0.100	0.000	0.004
A2	1.050	1.150	0.041	0.045
b	0.300	0.500	0.012	0.020
c	0.100	0.200	0.004	0.008
D	2.820	3.020	0.111	0.119
E	1.500	1.700	0.059	0.067
E1	2.650	2.950	0.104	0.116
e	0.950 BSC		0.037 BSC	
e1	1.900 BSC		0.075 BSC	
L	0.300	0.600	0.012	0.024
$\theta$	0°	8°	0°	8°



PACKAGE OUTLINE DIMENSIONS

UTDFN-1×1-4L

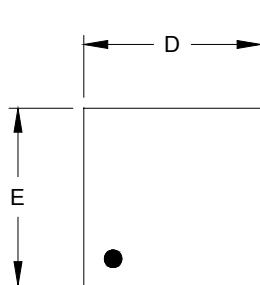

TOP VIEW

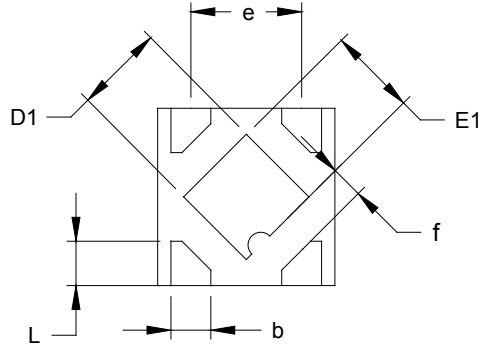

BOTTOM VIEW

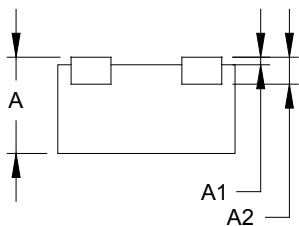

SIDE VIEW

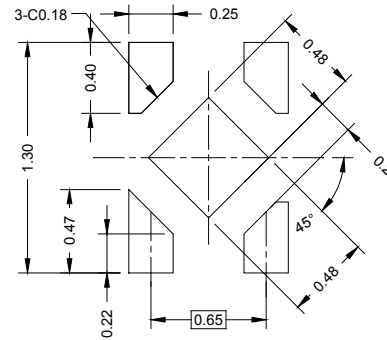

RECOMMENDED LAND PATTERN (Unit: mm)

Symbol	Dimensions In Millimeters		
	MIN	MOD	MAX
A	0.500	0.550	0.600
A1	0.000		0.050
A2	0.152 REF		
D	0.950	1.000	1.050
D1	0.450	0.500	0.550
E	0.950	1.000	1.050
E1	0.450	0.500	0.550
b	0.175	0.225	0.275
e	0.625 BSC		
f	0.195 REF		
L	0.200	0.250	0.300

# PACKAGE INFORMATION

## TAPE AND REEL INFORMATION

### REEL DIMENSIONS



### TAPE DIMENSIONS



NOTE: The picture is only for reference. Please make the object as the standard.

### KEY PARAMETER LIST OF TAPE AND REEL

Package Type	Reel Diameter	Reel Width W1 (mm)	A0 (mm)	B0 (mm)	K0 (mm)	P0 (mm)	P1 (mm)	P2 (mm)	W (mm)	Pin1 Quadrant
SC70-5	7"	9.5	2.25	2.55	1.20	4.0	4.0	2.0	8.0	Q3
SOT-23-5	7"	9.5	3.20	3.20	1.40	4.0	4.0	2.0	8.0	Q3
UTDFN-1×1-4L	7"	9.0	1.20	1.20	0.60	4.0	2.0	2.0	8.0	Q1

DD0001

# PACKAGE INFORMATION

## CARTON BOX DIMENSIONS



NOTE: The picture is only for reference. Please make the object as the standard.

## KEY PARAMETER LIST OF CARTON BOX

Reel Type	Length (mm)	Width (mm)	Height (mm)	Pizza/Carton
7" (Option)	368	227	224	8
7"	442	410	224	18

DD0002

## X-ON Electronics

Largest Supplier of Electrical and Electronic Components

*Click to view similar products for [LDO Voltage Regulators](#) category:*

*Click to view products by [SGMICRO](#) manufacturer:*

Other Similar products are found below :

[AP7363-SP-13](#) [L79M05TL-E](#) [AP7362-HA-7](#) [PT7M8202B12TA5EX](#) [TCR3DF185,LM\(CT](#) [TCR3DF45,LM\(CT](#) [TLE4473G V52](#) [059985X](#)  
[NCP4687DH15T1G](#) [701326R](#) [NCV8170AXV250T2G](#) [SCD337BTG](#) [AP7315-25W5-7](#) [AP2111H-1.2TRG1](#) [ZLDO1117QK50TC](#) [AZ1117ID-](#)  
[ADJTRG1](#) [TCR3DG12,LF](#) [MIC5514-3.3YMT-T5](#) [SCD7912BTG](#) [NCP154MX180270TAG](#) [SCD33269T-5.0G](#) [NCV8170BXV330T2G](#)  
[NCV8170BMX330TCG](#) [NCV8170AMX120TCG](#) [NCP706ABMX300TAG](#) [NCP153MX330180TCG](#) [NCP114BMX075TCG](#) [MC33269T-3.5G](#)  
[CAT6243-ADJCMT5T](#) [TCR3DG33,LF](#) [TCR4DG35,LF](#) [TAR5S15U\(TE85L,F\)](#) [TAR5S18U\(TE85L,F\)](#) [TCR3UG19A,LF](#) [TCR4DG105,LF](#)  
[MPQ2013AGG-5-P](#) [NCV8170AMX360TCG](#) [TLE4268GSXUMA2](#) [NCP715SQ15T2G](#) [MIC5317-3.0YD5-T5](#) [NCV563SQ18T1G](#)  
[NCP715MX30TBG](#) [NCV8702MX25TCG](#) [NCV8170BXV120T2G](#) [MIC5317-1.2YD5-T5](#) [NCV8170AMX150TCG](#) [NCV8170BMX150TCG](#)  
[AP2213D-3.3TRG1](#) [NCV8170BMX120TCG](#) [NCV8170BMX310TCG](#)