



SGM2576/SGM2576B

Power Distribution Switches

GENERAL DESCRIPTION

The SGM2576 and SGM2576B are single channel power distribution switches. The switches operate from a wide range of 2.5V to 5.5V supply voltage, and are controlled by the EN pin.

A 100mΩ low R_{ON} N-MOSFET is integrated. The small size and quiescent current make the device very suitable for space limited, battery-powered applications.

A number of protection features are provided in the device including soft-start, programmable current limit and thermal shutdown. This device provides a programmable current limit threshold between 100mA and 2.5A through the R_{ILIM}. Thermal shutdown shuts off the output MOSFET if the die temperature exceeds +150°C, and the output MOSFET remains off until the die temperature drops to +130°C.

SGM2576 and SGM2576B are available in a Green SOT-23-5 package. They are rated over the -40°C to +85°C temperature range.

FEATURES

- **Input Voltage Range: 2.5V to 5.5V**
- **On-Resistance: 100mΩ (TYP)**
- **Programmable Current Limit Range: 0.1A to 2.5A**
1500mA ± 190mA@R_{ILIM} = 4.53kΩ
- **Quiescent Current: 23μA (TYP)**
- **Shutdown Current: 0.1μA (TYP)**
- **Full Set of Protections**
 - ◆ **Soft-Start**
 - ◆ **Under-Voltage Lockout for VIN**
 - ◆ **No Reversed Leakage Current**
 - ◆ **Thermal Shutdown**
- **Automatic Output Discharge in Shutdown Mode (SGM2576 Only)**
- **500kΩ Pull-Down Resistor at EN Pin**
- **Evaluated to IEC 62368-1: 2014 (Certificate No. DK-90466-UL)**
- **Evaluated to IEC 60950-1, Ed 2, Am1, Annex CC, Test Program 1 with CB Report**
- **Available in a Green SOT-23-5 Package**

APPLICATIONS

Digital TV
Set-Top Boxes
Portable Medical Equipment
Battery Powered Equipment
Hot-Plug Power Supply
Motherboard USB Power Switch
USB Device Power Switch

PACKAGE/ORDERING INFORMATION

MODEL	PACKAGE DESCRIPTION	SPECIFIED TEMPERATURE RANGE	ORDERING NUMBER	PACKAGE MARKING	PACKING OPTION
SGM2576	SOT-23-5	-40°C to +85°C	SGM2576YN5G/TR	SU3XX	Tape and Reel, 3000
SGM2576B	SOT-23-5	-40°C to +85°C	SGM2576BYN5G/TR	ME4XX	Tape and Reel, 3000

MARKING INFORMATION

NOTE: XX = Date Code.

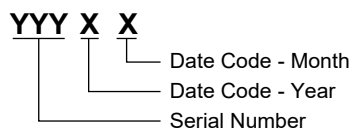

Green (RoHS & HSF): SG Micro Corp defines "Green" to mean Pb-Free (RoHS compatible) and free of halogen substances. If you have additional comments or questions, please contact your SGMICRO representative directly.

ABSOLUTE MAXIMUM RATINGS

All Pins.....	6V
Power Dissipation, P_D @ $T_A = +25^\circ\text{C}$	
SOT-23-5.....	0.3W
Package Thermal Resistance	
SOT-23-5, θ_{JA}	220°C/W
SOT-23-5, θ_{JC}	93°C/W
Junction Temperature.....	+150°C
Storage Temperature Range.....	-65°C to +150°C
Lead Temperature (Soldering, 10s).....	+260°C
ESD Susceptibility	
HBM.....	2000V
MM.....	400V
CDM.....	1000V

RECOMMENDED OPERATING CONDITIONS

Input Voltage Range.....	2.5V to 5.5V
EN Voltage Range.....	-0.3V to 5.5V
All Other Pins.....	0V to 5.5V
Operating Junction Temperature Range.....	-40°C to +125°C
Operating Ambient Temperature Range.....	-40°C to +85°C

OVERSTRESS CAUTION

Stresses beyond those listed in Absolute Maximum Ratings may cause permanent damage to the device. Exposure to absolute maximum rating conditions for extended periods may affect reliability. Functional operation of the device at any conditions beyond those indicated in the Recommended Operating Conditions section is not implied.

ESD SENSITIVITY CAUTION

This integrated circuit can be damaged if ESD protections are not considered carefully. SGMICRO recommends that all integrated circuits be handled with appropriate precautions. Failure to observe proper handling and installation procedures can cause damage. ESD damage can range from subtle performance degradation to complete device failure. Precision integrated circuits may be more susceptible to damage because even small parametric changes could cause the device not to meet the published specifications.

DISCLAIMER

SG Micro Corp reserves the right to make any change in circuit design, or specifications without prior notice.

PIN CONFIGURATION

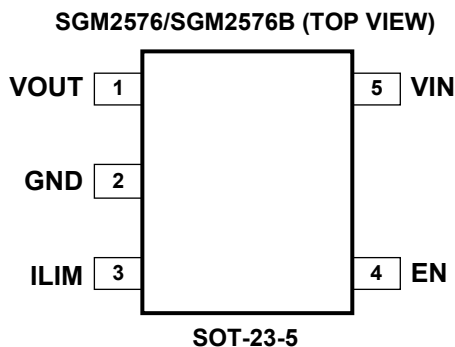

PIN DESCRIPTION

PIN	NAME	FUNCTION
1	VOUT	Switch Output.
2	GND	Ground.
3	ILIM	Current Limit Programming Pin. Connect a resistor R_{ILIM} from this pin to GND to program the current limit: $I_{LIM} = \frac{6800}{R_{ILIM}} \text{ (A)}$
4	EN	Chip Enable Pin. Logic high to enable the device. They have integrated a 500kΩ pull-down resistor at this pin.
5	VIN	Switch Input.

TEST CIRCUIT

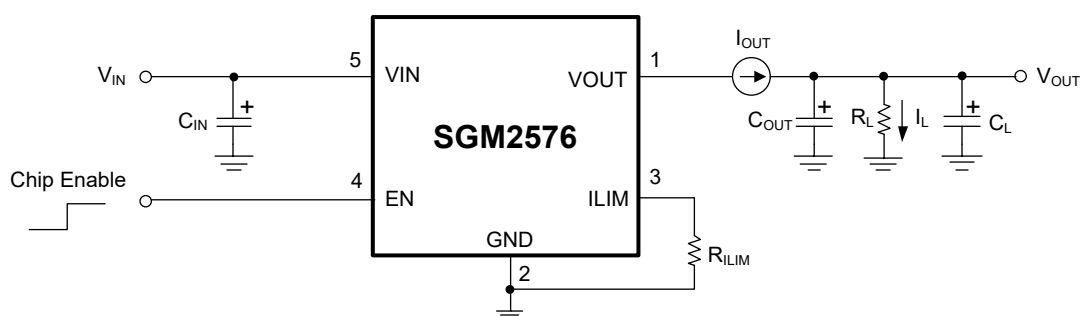

Figure 1. Test Circuit

ELECTRICAL CHARACTERISTICS

(T_A = +25°C, V_{IN} = 5V, unless otherwise noted.)

PARAMETER	SYMBOL	CONDITIONS	MIN	TYP	MAX	UNITS
Input Voltage Range	V _{IN}		2.5		5.5	V
Quiescent Current	I _Q	Switch on, V _{OUT} = Open		23	35	μA
Shutdown Current	I _{SD}	Switch off, V _{OUT} = Open		0.1		μA
Output Leakage Current	I _{LEAKAGE}	Switch off, V _{OUT} = 0V		0.1		μA
Enable Input Threshold	V _{IH}	V _{IN} = 2.5V to 5.5V	1.6			V
	V _{IL}	V _{IN} = 2.5V to 5.5V			0.4	
Pull-Down Resistor at EN Pin	R _{PULL_DOWN}			500		kΩ
Switch Resistance	R _{DS(ON)}	V _{IN} = 5V, I _{OUT} = 500mA		100		mΩ
Output Turn-On Delay Time	t _{ON}	R _L = 10Ω, C _L = 1μF, Figure 5		2.3		ms
Output Turn-Off Delay Time	t _{OFF}	R _L = 10Ω, C _L = 1μF, Figure 5		25		μs
Current Limit Threshold	I _{LIM}	R _{ILIM} = 38kΩ		180		mA
		R _{ILIM} = 17kΩ		400		
		R _{ILIM} = 6.8kΩ		1000		
		R _{ILIM} = 4.53kΩ	1310	1500	1690	
		R _{ILIM} = 3.4kΩ		2000		
		R _{ILIM} = 2.7kΩ		2500		
Under-Voltage Lockout Threshold	V _{UVLO}	V _{IN} rising		2.15	2.3	V
Under-Voltage Lockout Threshold Hysteresis				0.1		V
V _{OUT} Shutdown Discharge Resistance (SGM2576 Only)	R _{DIS}	Switch off		50		Ω
Thermal Shutdown Temperature		T _J increasing		150		°C
Thermal Shutdown Hysteresis				20		°C

TYPICAL PERFORMANCE CHARACTERISTICS

$T_A = +25^\circ\text{C}$, $V_{IN} = 5\text{V}$, unless otherwise noted.

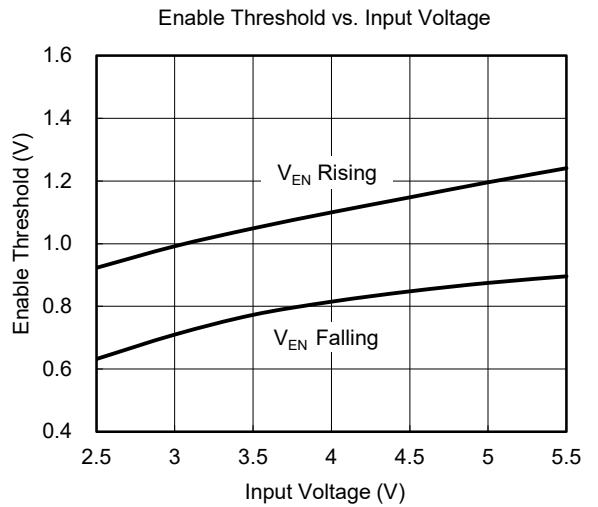
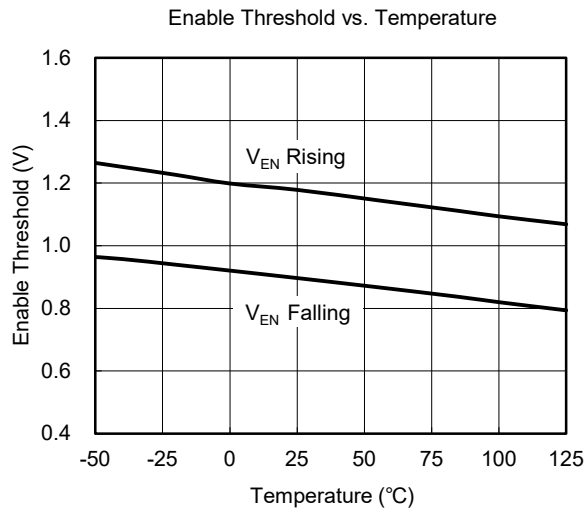
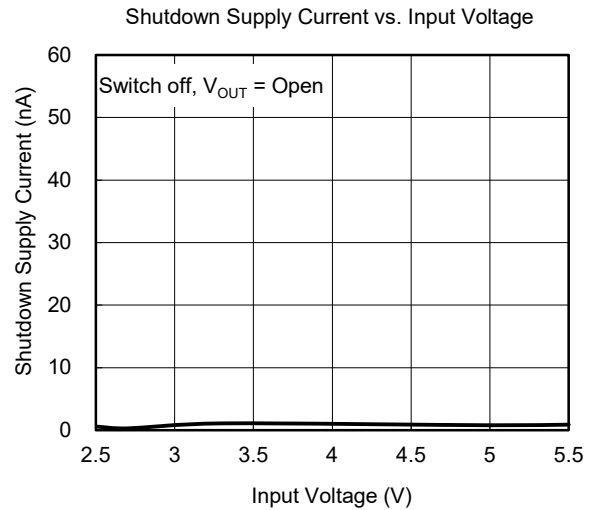
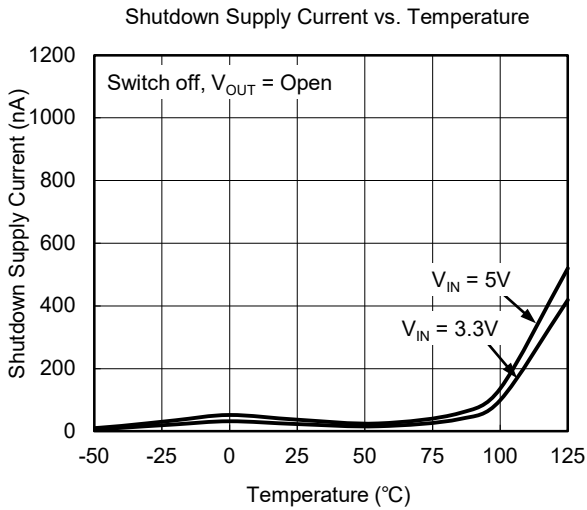
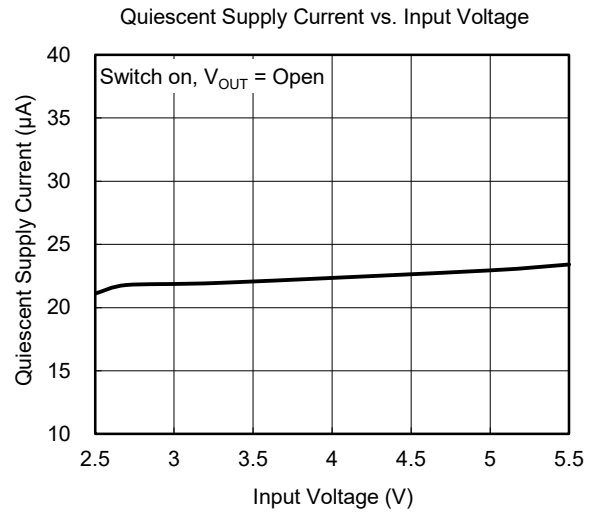
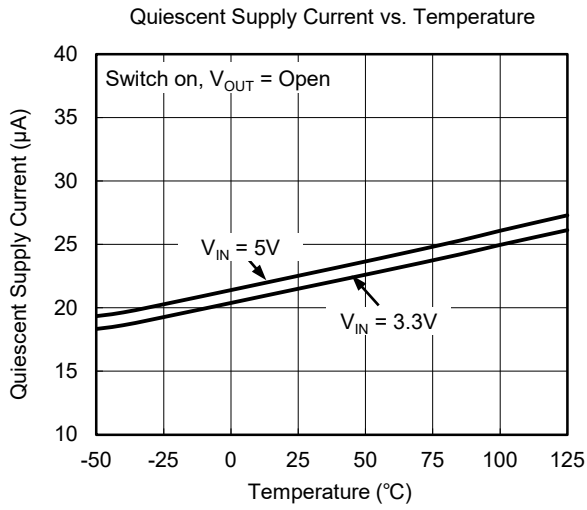

TYPICAL PERFORMANCE CHARACTERISTICS (continued)

$T_A = +25^\circ\text{C}$, $V_{IN} = 5\text{V}$, unless otherwise noted.

On-Resistance vs. Temperature

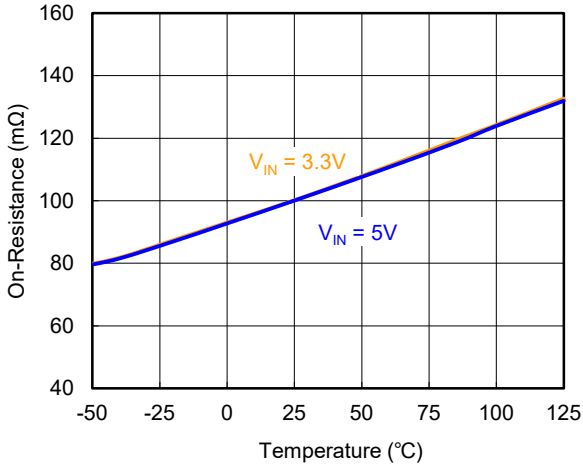

On-Resistance vs. Input Voltage

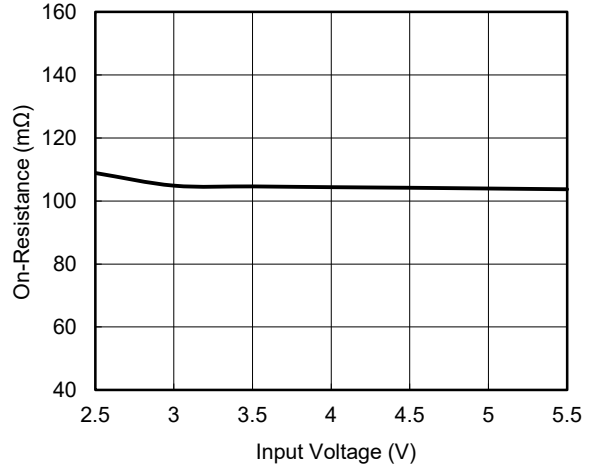

UVLO Threshold vs. Temperature

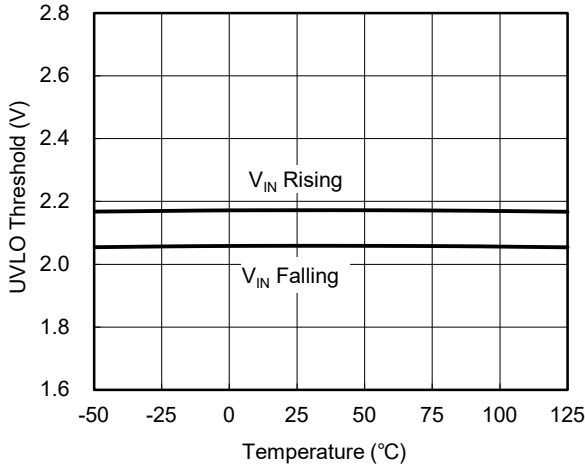

Supply Leakage Current vs. Temperature

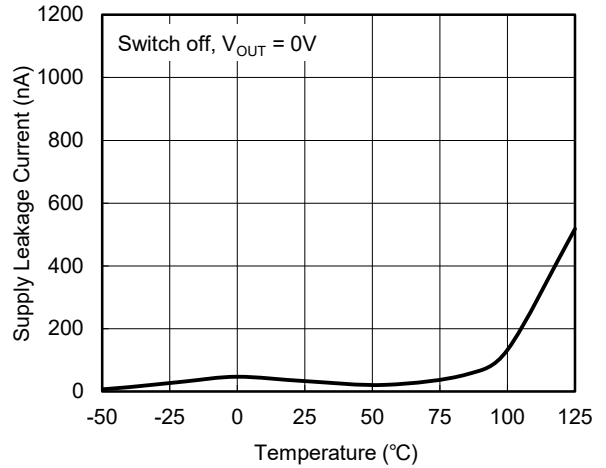

Turn-On (Rise) Time vs. Temperature

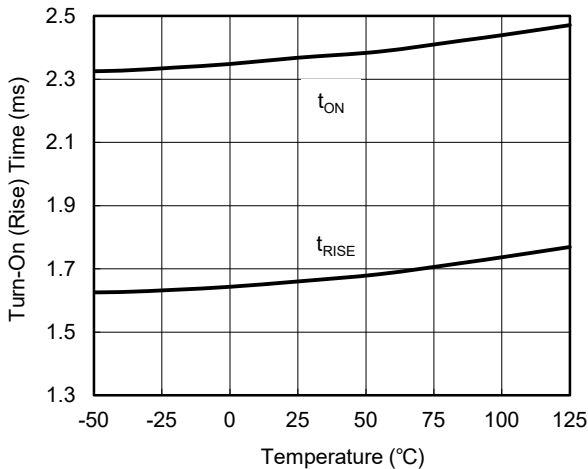

Turn-On (Rise) Time vs. Input Voltage

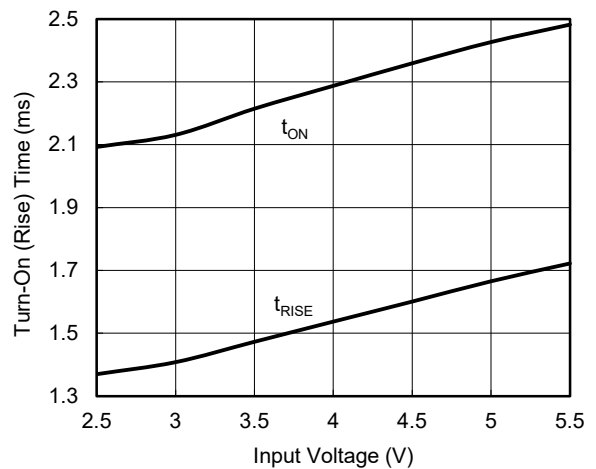

TYPICAL PERFORMANCE CHARACTERISTICS (continued)

$T_A = +25^\circ\text{C}$, $V_{IN} = 5\text{V}$, unless otherwise noted.

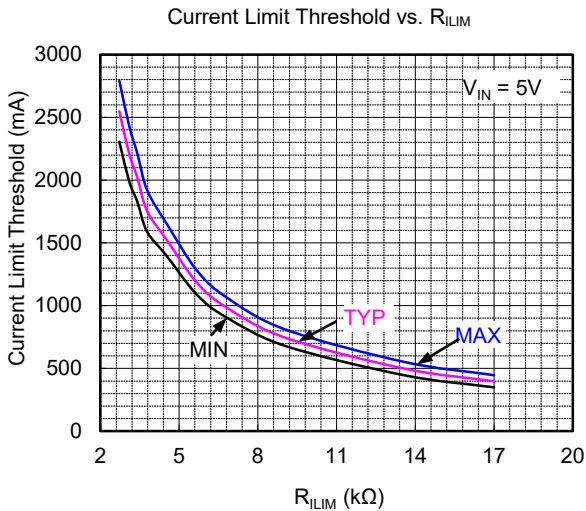
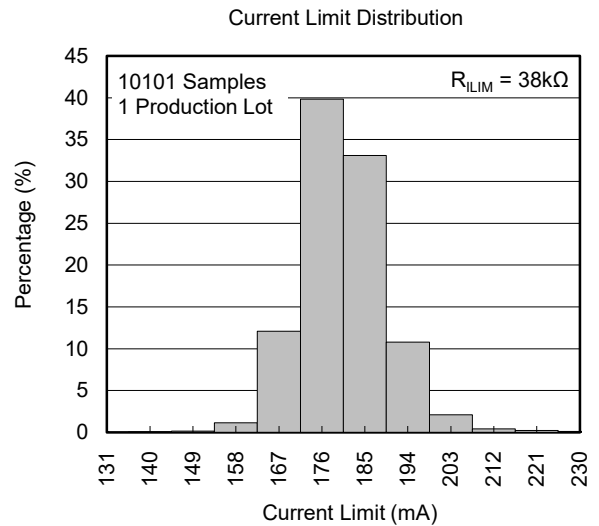
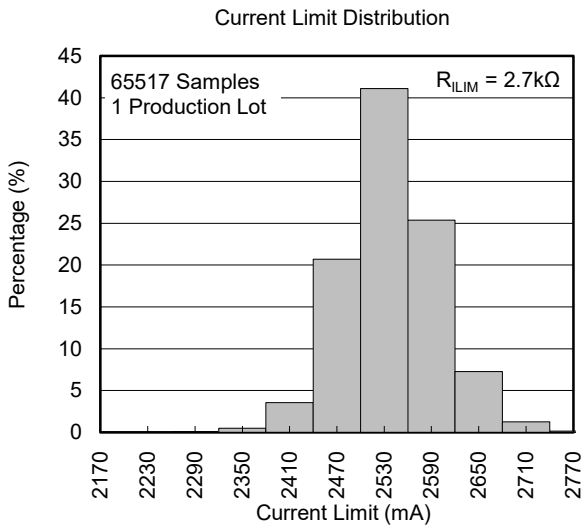
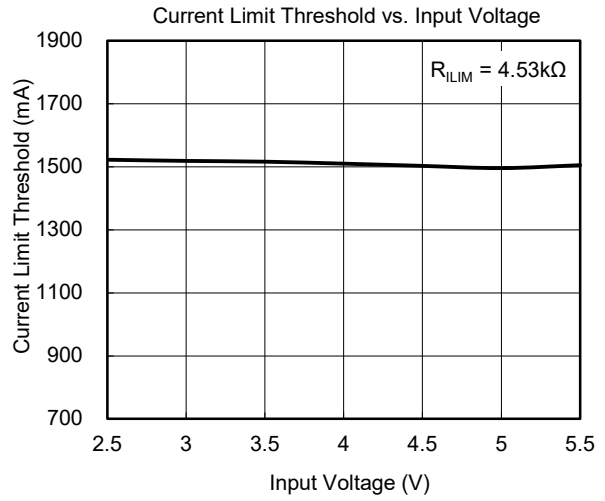
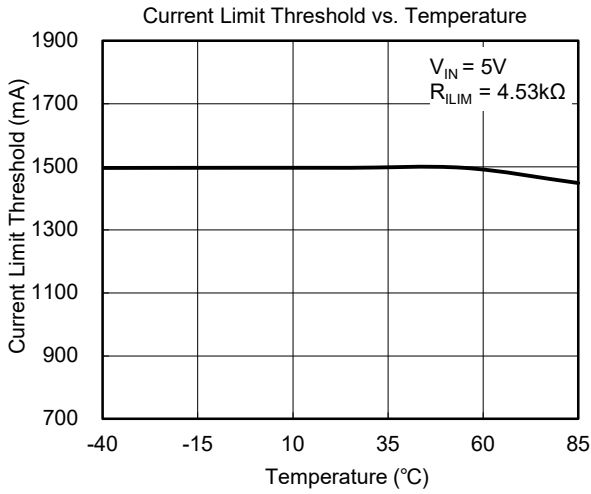

TYPICAL PERFORMANCE CHARACTERISTICS (continued)

$T_A = +25^\circ\text{C}$, $V_{IN} = 5\text{V}$, unless otherwise noted.

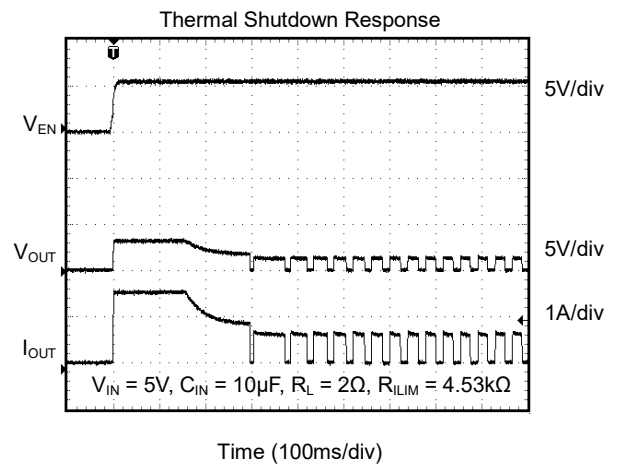
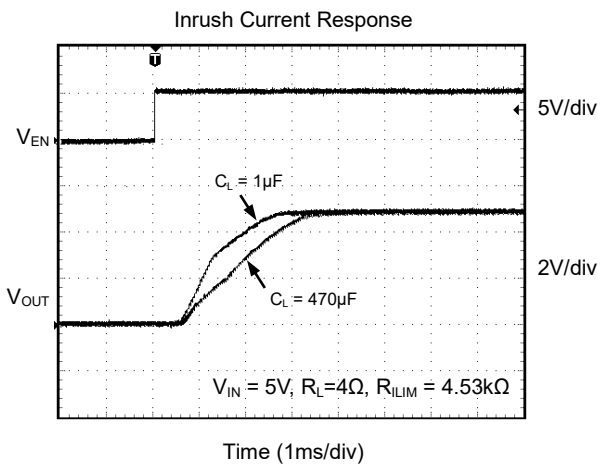
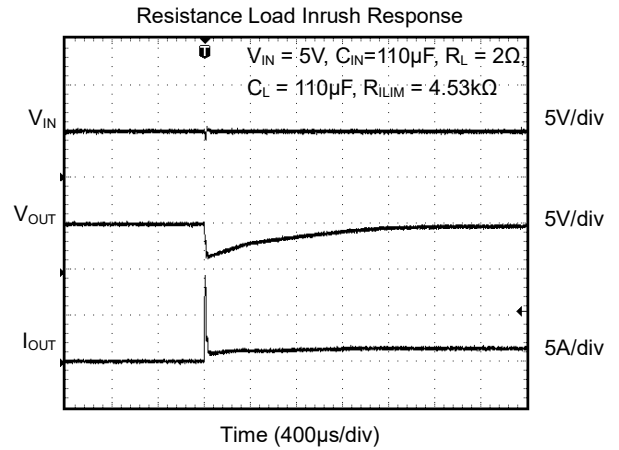
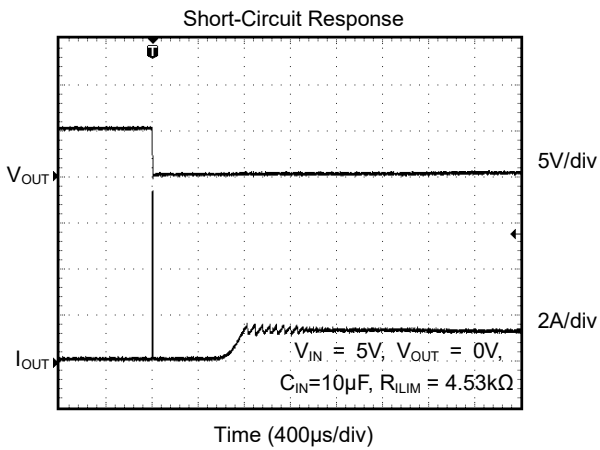
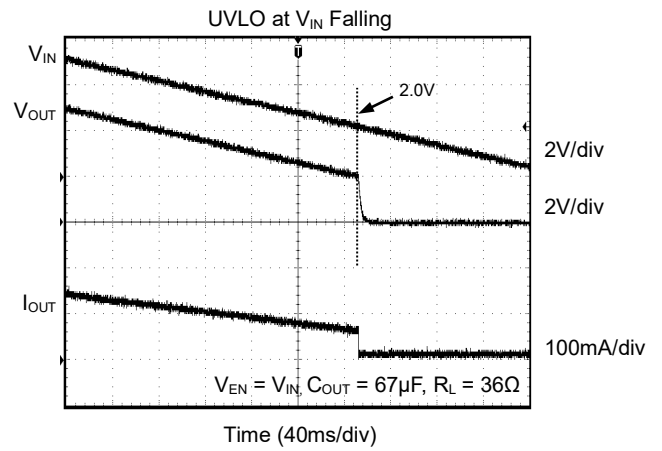
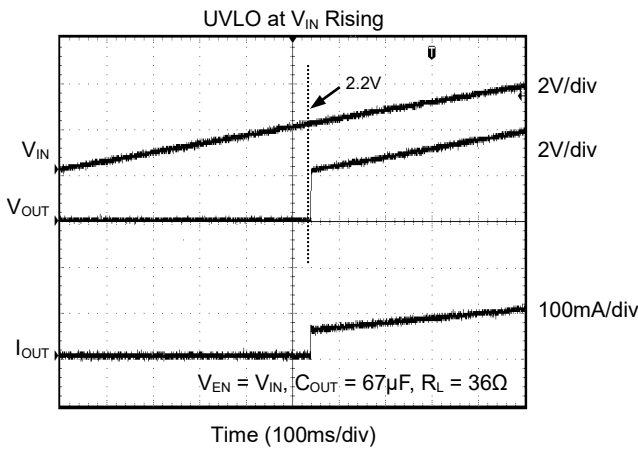

TYPICAL PERFORMANCE CHARACTERISTICS (continued)

$T_A = +25^\circ\text{C}$, $V_{IN} = 5\text{V}$, unless otherwise noted.

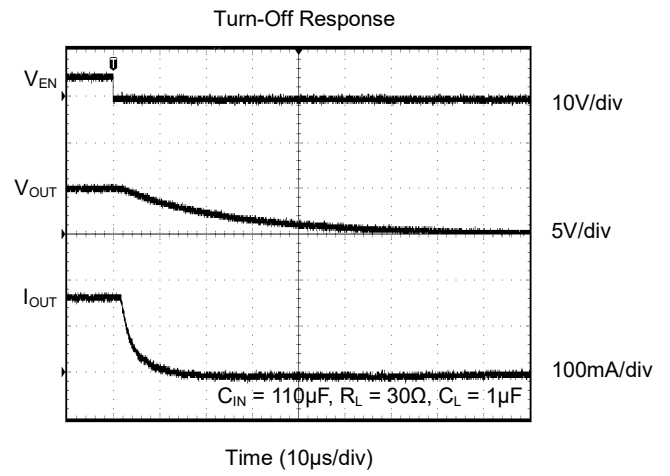
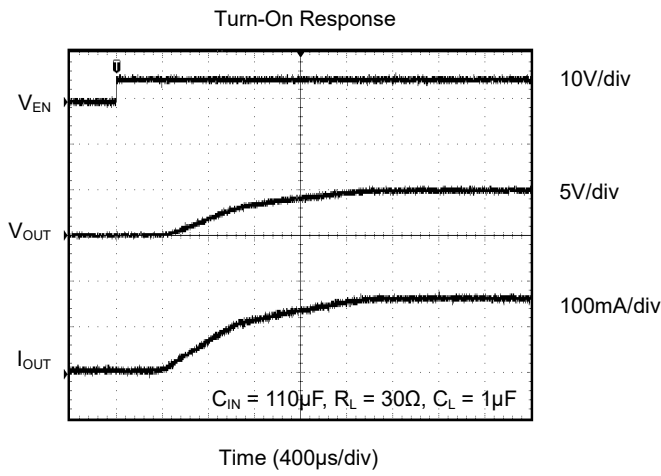

FUNCTIONAL BLOCK DIAGRAMS

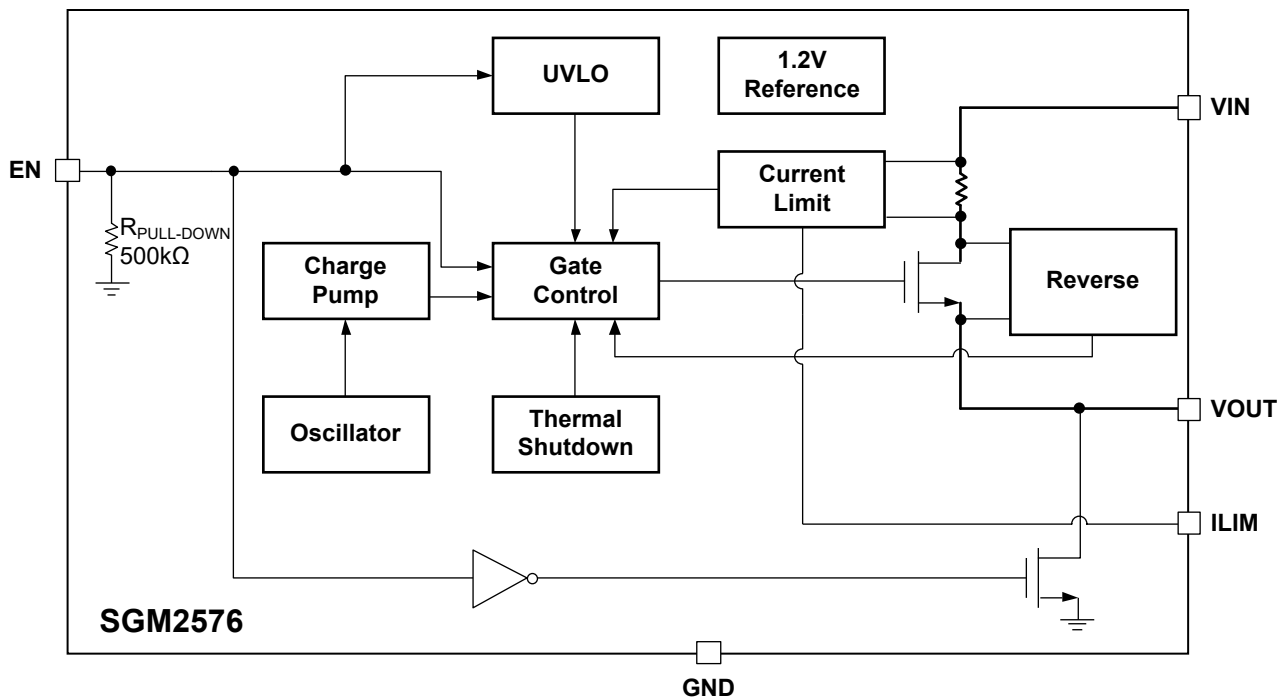

Figure 2. SGM2576 Block Diagram

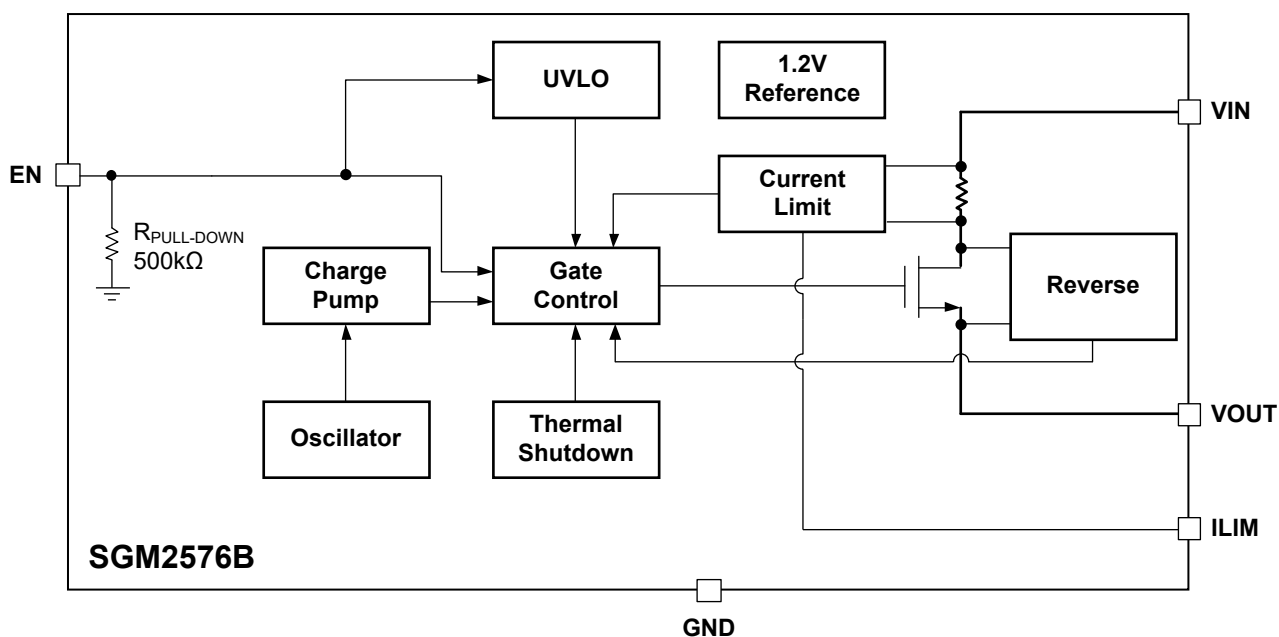

Figure 3. SGM2576B Block Diagram

REVISION HISTORY

NOTE: Page numbers for previous revisions may differ from page numbers in the current version.

FEBRUARY 2020 – REV.A.4 to REV.B	Page
Updated Features section.....	1
Updated Electrical Characteristics section.....	4
Updated Typical Performance Characteristics section.....	7

FEBRUARY 2019 – REV.A.3 to REV.A.4	Page
Updated Absolute Maximum Ratings section.....	2

MARCH 2018 – REV.A.2 to REV.A.3	Page
Added SGM2576B Version.....	All

DECEMBER 2017 – REV.A.1 to REV.A.2	Page
Update Feature section.....	1

APRIL 2016 – REV.A to REV.A.1	Page
Changed Reverse-Voltage Protection section.....	10

Changes from Original (OCTOBER 2015) to REV.A	Page
Changed from product preview to production data.....	All

PACKAGE OUTLINE DIMENSIONS

SOT-23-5

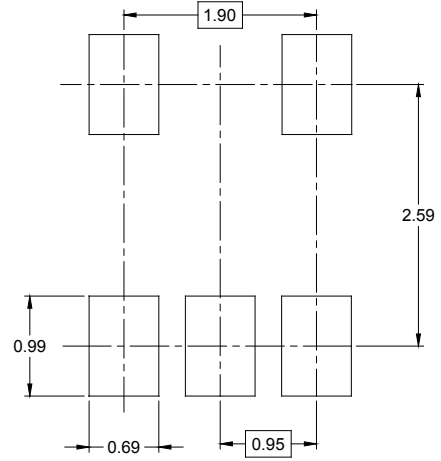
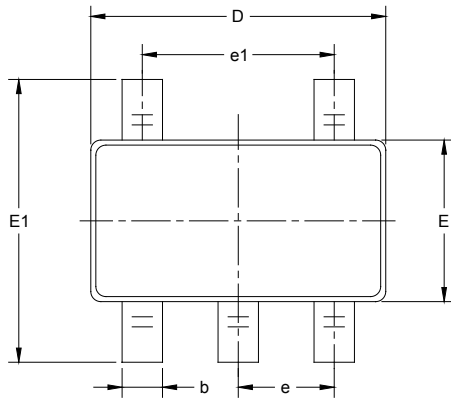

RECOMMENDED LAND PATTERN (Unit: mm)

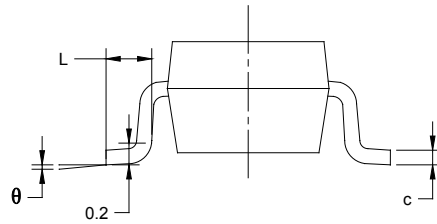
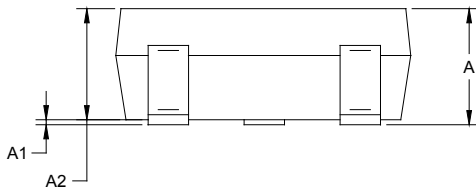

Symbol	Dimensions In Millimeters		Dimensions In Inches	
	MIN	MAX	MIN	MAX
A	1.050	1.250	0.041	0.049
A1	0.000	0.100	0.000	0.004
A2	1.050	1.150	0.041	0.045
b	0.300	0.500	0.012	0.020
c	0.100	0.200	0.004	0.008
D	2.820	3.020	0.111	0.119
E	1.500	1.700	0.059	0.067
E1	2.650	2.950	0.104	0.116
e	0.950 BSC		0.037 BSC	
e1	1.900 BSC		0.075 BSC	
L	0.300	0.600	0.012	0.024
θ	0°	8°	0°	8°

PACKAGE INFORMATION

TAPE AND REEL INFORMATION

REEL DIMENSIONS



TAPE DIMENSIONS



NOTE: The picture is only for reference. Please make the object as the standard.

KEY PARAMETER LIST OF TAPE AND REEL

Package Type	Reel Diameter	Reel Width W1 (mm)	A0 (mm)	B0 (mm)	K0 (mm)	P0 (mm)	P1 (mm)	P2 (mm)	W (mm)	Pin1 Quadrant
SOT-23-5	7"	9.5	3.20	3.20	1.40	4.0	4.0	2.0	8.0	Q3

DD0001

PACKAGE INFORMATION

CARTON BOX DIMENSIONS



NOTE: The picture is only for reference. Please make the object as the standard.

KEY PARAMETER LIST OF CARTON BOX

Reel Type	Length (mm)	Width (mm)	Height (mm)	Pizza/Carton
7" (Option)	368	227	224	8
7"	442	410	224	18

DD0002

X-ON Electronics

Largest Supplier of Electrical and Electronic Components

Click to view similar products for [Power Switch ICs - Power Distribution](#) category:

Click to view products by [SGMICRO](#) manufacturer:

Other Similar products are found below :

[TLE6232GP](#) [NCP45520IMNTWG-L](#) [FPF1018](#) [DS1222](#) [NCV380HMUAJAATBG](#) [TCK2065G,LF](#) [SZNCP3712ASNT3G](#)
[NCP45520IMNTWG-H](#) [VND5004ATR-E](#) [ITS5215LXT](#) [AP22811BW5-7](#) [SLG5NT1437VTR](#) [SZNCP3712ASNT1G](#) [DML1008LDS-7](#)
[KTS1640QGDV-TR](#) [KTS1641QGDV-TR](#) [NCV459MNWTBG](#) [NCP4545IMNTWG-L](#) [FPF2260ATMX](#) [SLG5NT1765V](#) [SLG5NT1757V](#)
[NCP45780IMN24RTWG](#) [AP2151AMP-13](#) [NCP45540IMNTWG-L](#) [TPS2022P](#) [FPF2495BUCX](#) [NCP45650IMNTWG](#) [NCV8412ADDR2G](#)
[DK5V100R20S](#) [JW7111SSOTB#TRPBF](#) [RY2121](#) [TPNTGD1100LT1G](#) [TPS27081ADDCR-TP](#) [FDC6331L-TP](#) [FDC6329L-TP](#) [FDC6323L-](#)
[TP](#) [SI3865DDV](#) [TPS2116DRLR](#) [U3213](#) [BTS7020-2EPA](#) [BTT6100-2ERA](#) [BTS71220-4ESA](#) [RS2588CYF5](#) [RS2580XTDE8](#) [LP5308B6F](#)
[ME1502AM5G](#) [SGM2576YN5G/TR](#) [DK5V100R15M](#) [SY6287CDEC](#) [BSP75N](#)