

### GENERAL DESCRIPTION

The SGM5532 is a high-performance operational amplifier combining excellent DC and AC characteristics. It features very low noise, high output-drive capability, high unity-gain and maximum output-swing bandwidths, low distortion, high slew rate, input protection diodes and output short-circuit protection. The operational amplifier is compensated internally for unity-gain operation.

The SGM5532 is available in a Green SOIC-8 package. It operates over an ambient temperature range of -40°C to +85°C.

### FEATURES

- **Equivalent Input Noise Voltage:**  
 $5nV/\sqrt{Hz}$  (TYP) at 1kHz
- **Unity-Gain Bandwidth:** 8.5MHz (TYP)
- **Common Mode Rejection Ratio:** 140dB (TYP)
- **High DC Voltage Gain:** 140dB (TYP)
- **High Slew Rate:** 18V/μs (TYP)
- **-40°C to +85°C Operating Temperature Range**
- **Available in a Green SOIC-8 Package**

### APPLICATIONS

- AV Receivers
- Embedded PCs
- Netbooks
- Video Broadcasting and Infrastructure: Scalable Platforms
- DVD Recorders and Players
- Multichannel Video Transcoders
- Pro Audio Mixers

### SIMPLIFIED SCHEMATIC

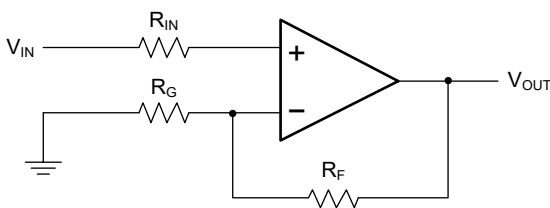
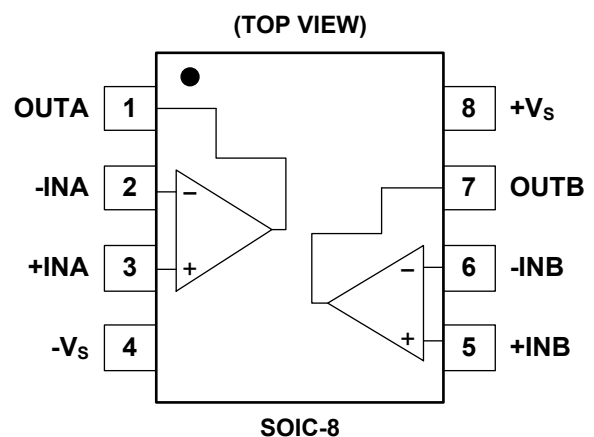

Figure 1. Simplified Schematic

### PIN CONFIGURATION



**PACKAGE/ORDERING INFORMATION**

MODEL	PACKAGE DESCRIPTION	SPECIFIED TEMPERATURE RANGE	ORDERING NUMBER	PACKAGE MARKING	PACKING OPTION
SGM5532	SOIC-8	-40°C to +85°C	SGM5532YS8G/TR	SGM 5532YS8 XXXXX	Tape and Reel, 4000

NOTE: XXXXX = Date Code and Vendor Code.

**MARKING INFORMATION**

NOTE: XXXXX = Date Code and Vendor Code.

**XXXXX**

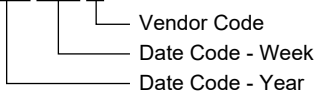

Green (RoHS & HSF): SG Micro Corp defines "Green" to mean Pb-Free (RoHS compatible) and free of halogen substances. If you have additional comments or questions, please contact your SGMICRO representative directly.

**ABSOLUTE MAXIMUM RATINGS**

- Supply Voltage, +V<sub>s</sub> to -V<sub>s</sub>..... 40V
- Input Common Mode Voltage Range  
..... (-V<sub>s</sub>) - 0.3V to (+V<sub>s</sub>) + 0.3V
- Junction Temperature ..... +150°C
- Storage Temperature Range..... -65°C to +150°C
- Lead Temperature (Soldering, 10s) ..... +260°C
- ESD Susceptibility
- HBM..... 5000V
- MM..... 200V
- CDM ..... 1000V

**RECOMMENDED OPERATING CONDITIONS**

- Supply Voltage, +V<sub>s</sub> to -V<sub>s</sub>..... 5V to 36V
- Operating Temperature Range ..... -40°C to +85°C

**OVERSTRESS CAUTION**

Stresses beyond those listed in Absolute Maximum Ratings may cause permanent damage to the device. Exposure to absolute maximum rating conditions for extended periods

may affect reliability. Functional operation of the device at any conditions beyond those indicated in the Recommended Operating Conditions section is not implied.

**ESD SENSITIVITY CAUTION**

This integrated circuit can be damaged if ESD protections are not considered carefully. SGMICRO recommends that all integrated circuits be handled with appropriate precautions. Failure to observe proper handling and installation procedures can cause damage. ESD damage can range from subtle performance degradation to complete device failure. Precision integrated circuits may be more susceptible to damage because even small parametric changes could cause the device not to meet the published specifications.

**DISCLAIMER**

SG Micro Corp reserves the right to make any change in circuit design, or specifications without prior notice.

## ELECTRICAL CHARACTERISTICS

(At  $T_A = +25^\circ\text{C}$ , Full =  $-40^\circ\text{C}$  to  $+85^\circ\text{C}$ ,  $V_S = \pm 15\text{V}$ ,  $R_L = 2\text{k}\Omega$  connected to  $0\text{V}$ , unless otherwise noted.)

PARAMETER	SYMBOL	CONDITIONS	TEMP	MIN	TYP	MAX	UNITS
<b>Input Characteristics</b>							
Input Offset Voltage	$V_{OS}$	$V_{CM} = 0\text{V}$	+25°C		100	500	$\mu\text{V}$
			Full			620	
Input Offset Voltage Drift	$\Delta V_{OS}/\Delta T$		Full		0.6		$\mu\text{V}/^\circ\text{C}$
Input Bias Current	$I_B$	$V_{CM} = 0\text{V}$	+25°C		550	750	nA
			Full			900	
Input Offset Current	$I_{OS}$	$V_{CM} = 0\text{V}$	+25°C		10	70	nA
			Full			100	
Input Common Mode Voltage Range	$V_{CM}$		Full	-13		13	V
Common Mode Rejection Ratio	CMRR	$V_S = \pm 15\text{V}$ , $-13\text{V} < V_{CM} < 13\text{V}$	+25°C	128	140		dB
			Full	124			
Open-Loop Voltage Gain	$A_{OL}$	$V_S = \pm 15\text{V}$ , $V_{OUT} = \pm 10\text{V}$ , $R_L = 2\text{k}\Omega$	+25°C	128	140		dB
			Full	120			
			+25°C	112	128		
			Full	108			
<b>Output Characteristics</b>							
Output Voltage Swing from Rail	$V_{OUT}$	$V_S = \pm 15\text{V}$ , $R_L = 2\text{k}\Omega$	+25°C		150	185	mV
			Full			230	
			+25°C		550	660	
			Full			840	
Output Short-Circuit Current	$I_{SC}$	$V_S = \pm 15\text{V}$	+25°C	$\pm 27$	$\pm 36$		mA
<b>Power Supply</b>							
Operating Voltage Range	$V_S$		Full	5		36	V
Quiescent Current	$I_Q$	$I_{OUT} = 0$	+25°C		8.5	17.5	mA
			Full			18	
Power Supply Rejection Ratio	PSRR	$V_S = 5\text{V}$ to $36\text{V}$	+25°C	122	138		dB
			Full	119			
<b>Dynamic Performance</b>							
Gain-Bandwidth Product	GBP	$f = 10\text{kHz}$			20		MHz
Slew Rate	SR				18		$\text{V}/\mu\text{s}$
Overload Recovery Time	ORT	$V_{IN} \times G = V_S$			1.2		$\mu\text{s}$
Maximum Output-Swing Bandwidth	$B_{OM}$	$V_S = \pm 15\text{V}$ , $V_{OUT} = \pm 10\text{V}$ , $R_L = 600\Omega$			280		kHz
Unity-Gain Bandwidth	$B_1$	$R_L = 600\Omega$			8.5		MHz
Total Harmonic Distortion + Noise	THD+N	$V_S = \pm 15\text{V}$ , $V_{OUT} = 10\text{V}_{P-P}$ , $f = 1\text{kHz}$ , $G = +1$ , $R_L = 600\Omega$			0.00005		%
<b>Noise</b>							
Input Voltage Noise		$f = 0.1\text{Hz}$ to $10\text{Hz}$			0.3		$\mu\text{V}_{P-P}$
Input Voltage Noise Density	$e_n$	$f = 30\text{Hz}$			15		$\text{nV}/\sqrt{\text{Hz}}$
		$f = 1\text{kHz}$			5		
Input Current Noise Density	$i_n$	$f = 30\text{Hz}$			3		$\text{pA}/\sqrt{\text{Hz}}$
		$f = 1\text{kHz}$			1		

TYPICAL PERFORMANCE CHARACTERISTICS

At  $T_A = +25^\circ\text{C}$ ,  $V_S = \pm 15\text{V}$  and  $R_L = 2\text{k}\Omega$ , unless otherwise noted.

Large-Signal Step Response

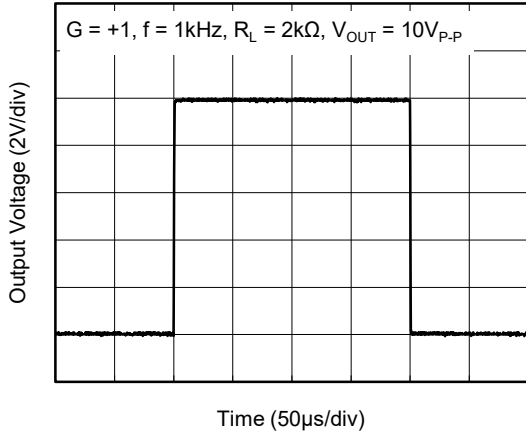

Small-Signal Step Response

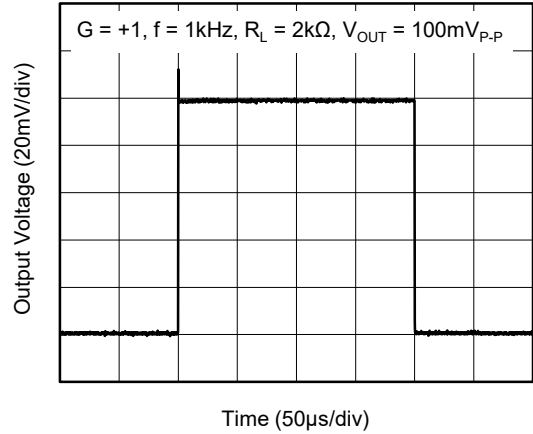

Positive Overload Recovery

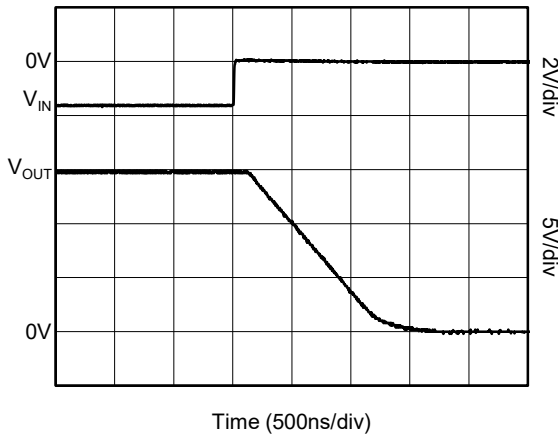

Negative Overload Recovery

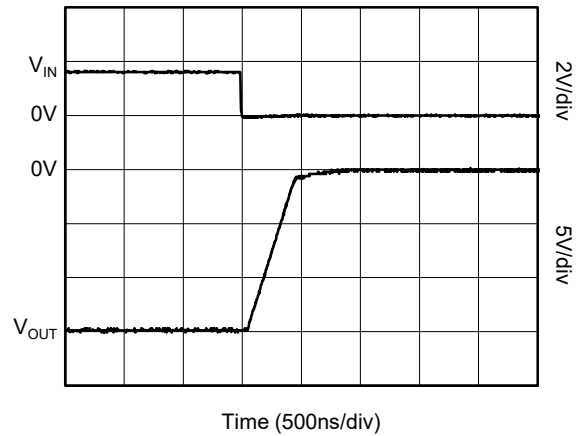

Input Offset Voltage vs. Input Common Mode Voltage

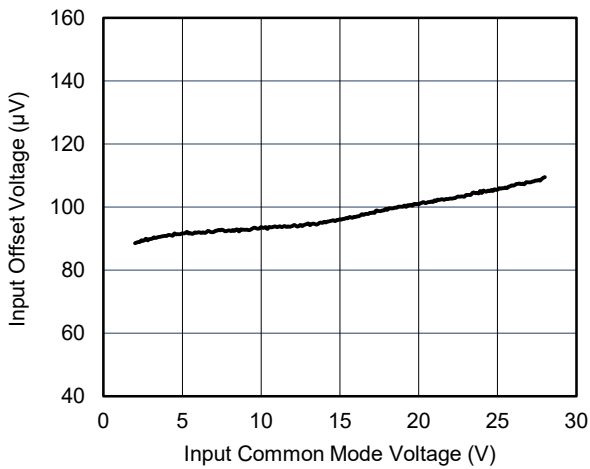

Output Voltage vs. Output Current

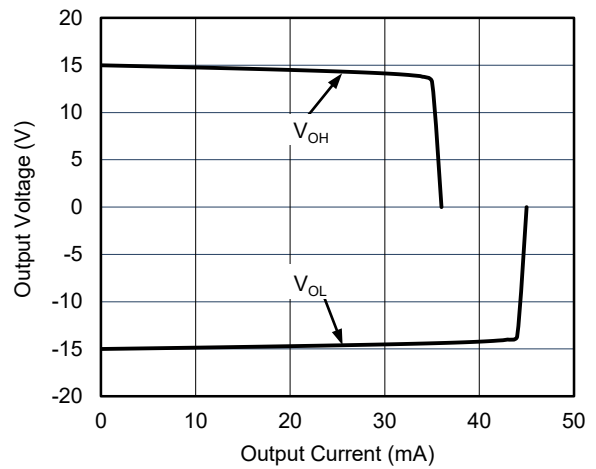

TYPICAL PERFORMANCE CHARACTERISTICS (continued)

At  $T_A = +25^\circ\text{C}$ ,  $V_S = \pm 15\text{V}$  and  $R_L = 2\text{k}\Omega$ , unless otherwise noted.

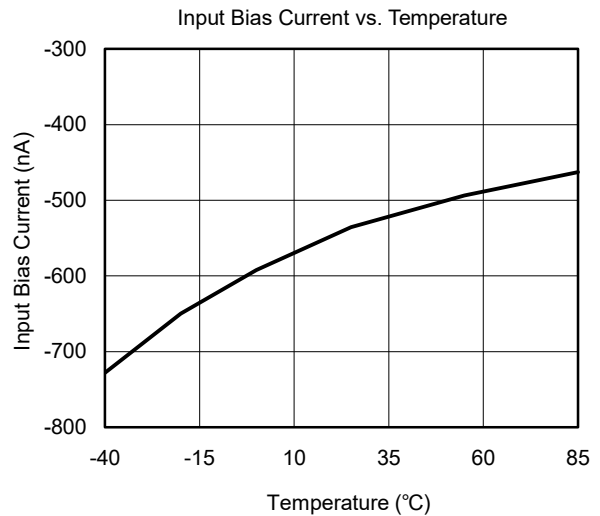
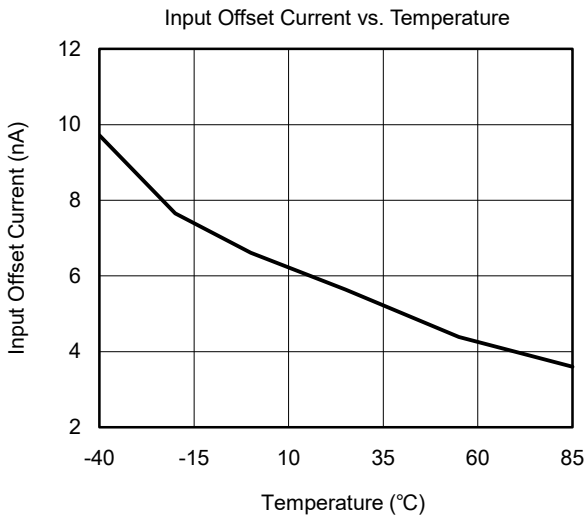
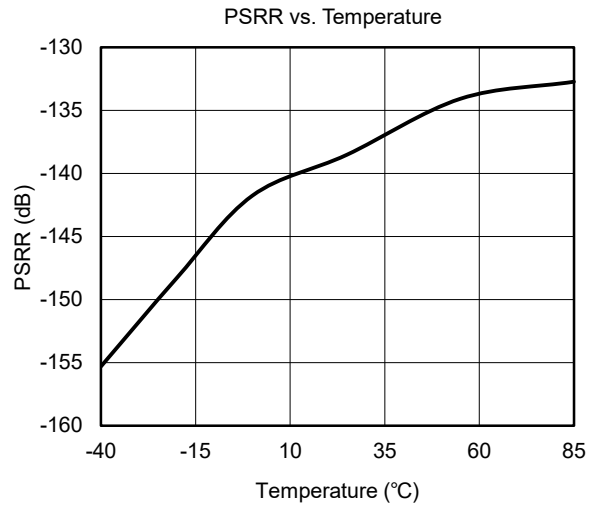
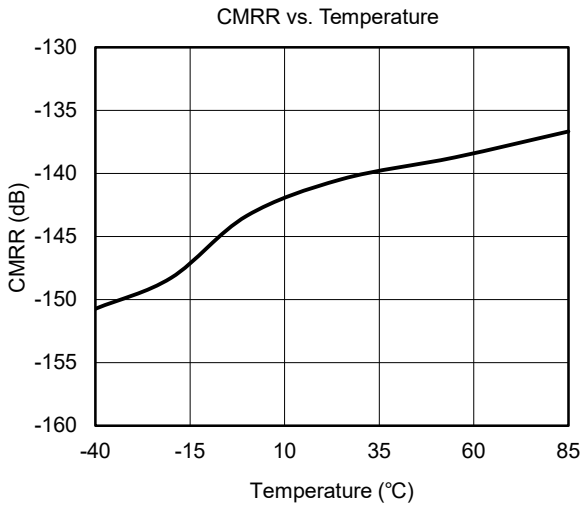
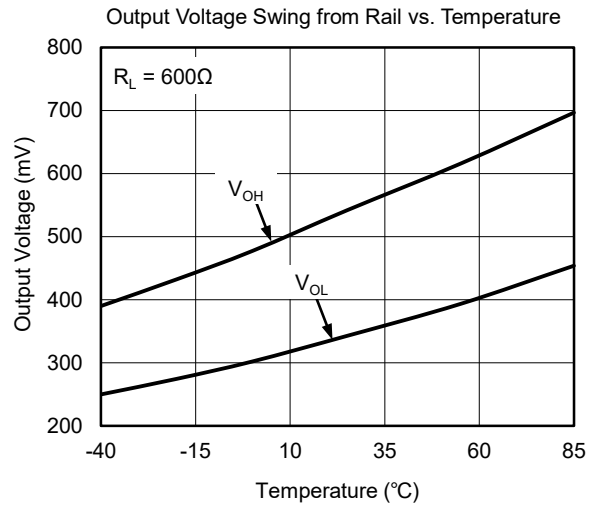
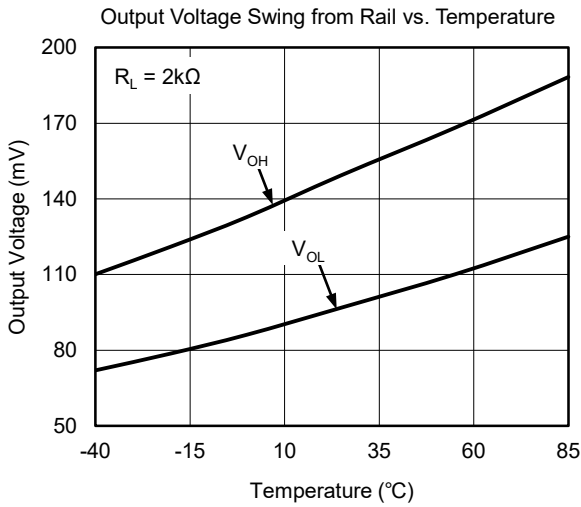

TYPICAL PERFORMANCE CHARACTERISTICS (continued)

At  $T_A = +25^\circ\text{C}$ ,  $V_S = \pm 15\text{V}$  and  $R_L = 2\text{k}\Omega$ , unless otherwise noted.

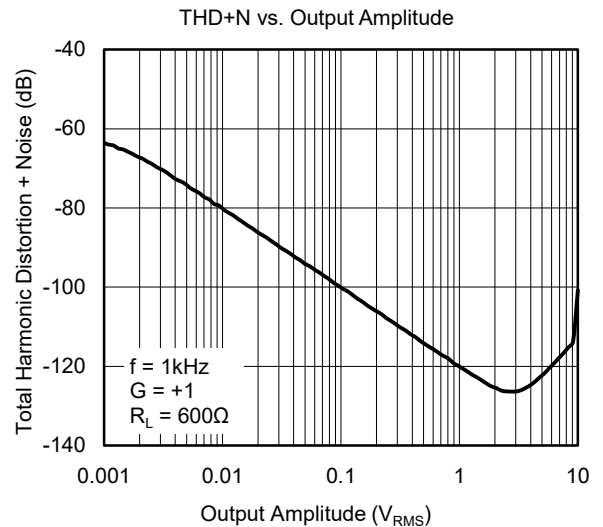
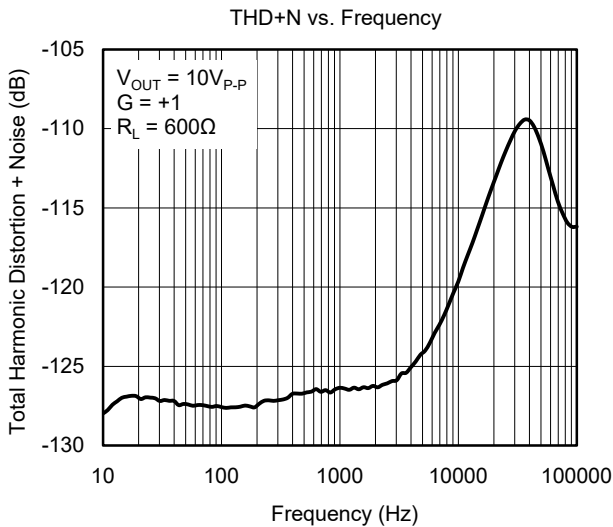
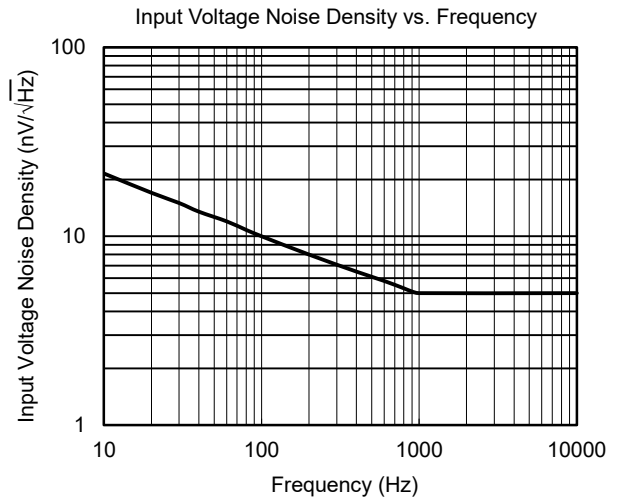
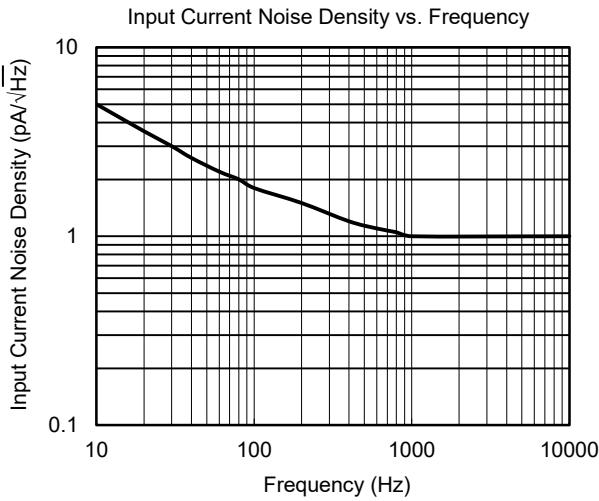
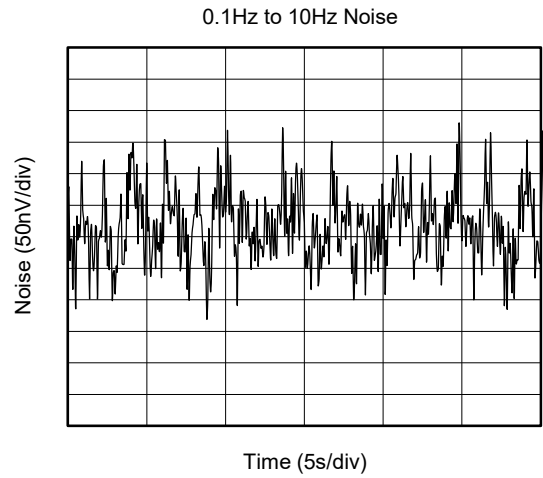
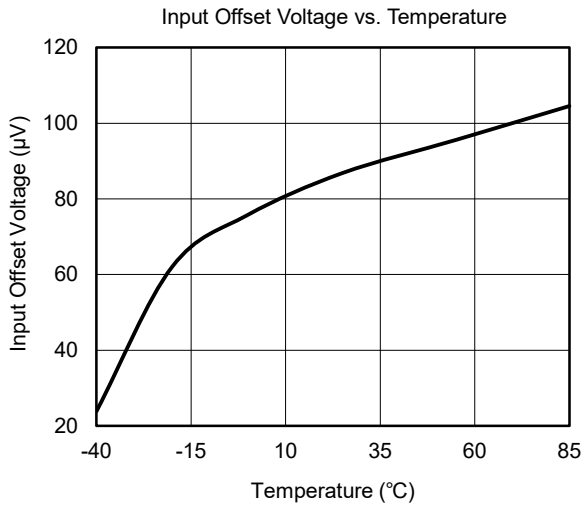

TYPICAL PERFORMANCE CHARACTERISTICS (continued)

At  $T_A = +25^\circ\text{C}$ ,  $V_S = \pm 15\text{V}$  and  $R_L = 2\text{k}\Omega$ , unless otherwise noted.

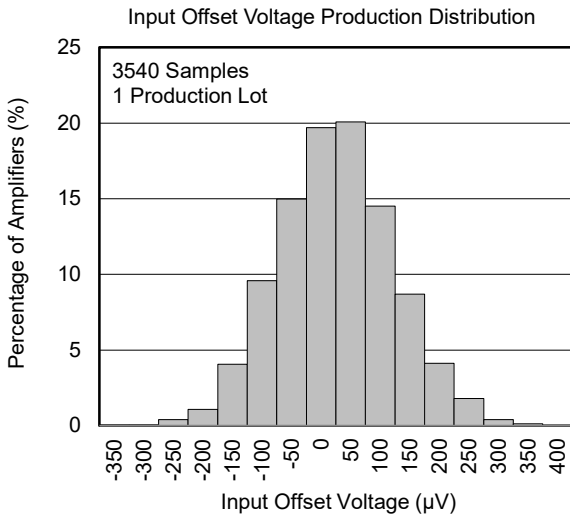
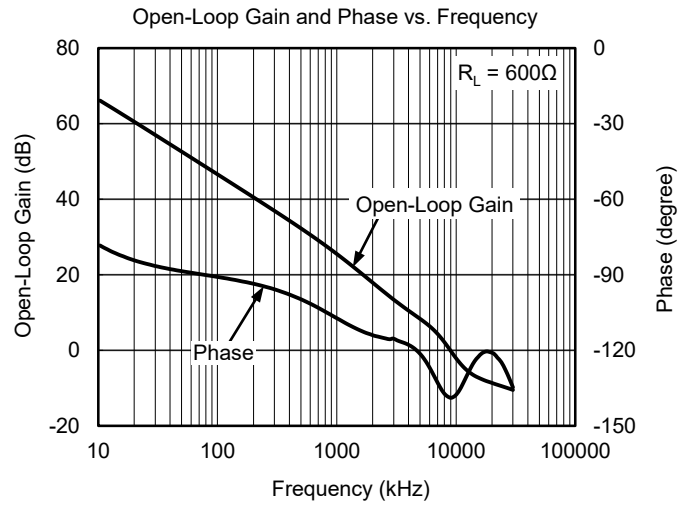
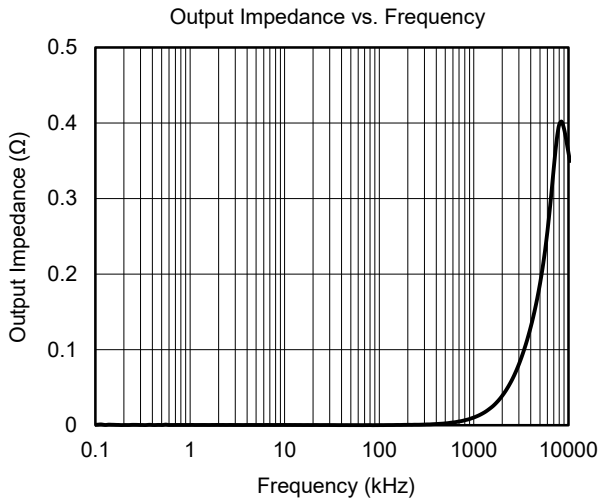

## DETAILED DESCRIPTION

The SGM5532 is a high-performance operational amplifier combining excellent DC and AC characteristics. It features very low noise, high output-drive capability, high unity-gain and maximum-output-swing bandwidths, low distortion, high slew rate, input-protection diodes and output short-circuit protection. The operational amplifier is compensated internally for unity-gain operation.

### Unity-Gain Bandwidth

The unity-gain bandwidth is the frequency up to which an amplifier with a unity gain may be operated without greatly distorting the signal. The SGM5532 device has an 8.5MHz unity-gain bandwidth.

### Common Mode Rejection Ratio

The common mode rejection ratio (CMRR) of an amplifier is a measure of how well the device rejects unwanted input signals common to both input leads. It

is found by taking the ratio of the change in input common mode voltage to the change in input offset voltage and converting to decibels. The CMRR of the SGM5532 device is 140dB.

### Slew Rate

The slew rate is the rate at which an operational amplifier can change its output when there is a change on the input. The SGM5532 device has an 18V/ $\mu$ s slew rate.

### Device Functional Modes

The SGM5532 device is powered on when the supply is connected. The device can be operated as a single-supply operational amplifier or dual-supply amplifier depending on the application.

## POWER SUPPLY RECOMMENDATIONS

The SGM5532 device is specified for operation over the range of  $\pm 2.5V$  to  $\pm 18V$ . Place 0.1 $\mu$ F bypass capacitors close to the power supply pins to reduce errors coupling in from noisy or high impedance power supplies. For more detailed information on bypass capacitor placement, refer to the Layout Guidelines.

### Caution

Supply voltages outside of the  $\pm 18V$  range can permanently damage the device (see the Absolute Maximum Ratings).



## APPLICATION INFORMATION

Some applications require differential signals. Figure 2 shows a simple circuit to convert a single-ended input of 2V to 10V into differential output of  $\pm 8V$  on a single 15V supply. The output range is intentionally limited to maximize linearity. The circuit is composed of two

amplifiers. One amplifier acts as a buffer and creates a voltage,  $V_{OUT+}$ . The second amplifier inverts the input and adds a reference voltage to generate  $V_{OUT-}$ . Both  $V_{OUT+}$  and  $V_{OUT-}$  range from 2V to 10V. The difference,  $V_{DIFF}$ , is the difference between  $V_{OUT+}$  and  $V_{OUT-}$ .

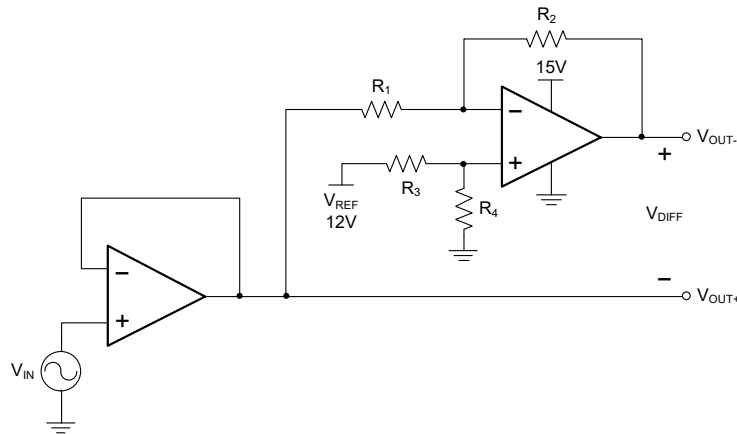

Figure 2. Schematic for Single-Ended Input to Differential Output Conversion

## Detailed Design Procedure

The circuit in Figure 2 takes a single-ended input signal,  $V_{IN}$ , and generates two output signals,  $V_{OUT+}$  and  $V_{OUT-}$  using two amplifiers and a reference voltage,  $V_{REF}$ .  $V_{OUT+}$  is the output of the first amplifier and is a buffered version of the input signal,  $V_{IN}$  in Equation 1.  $V_{OUT-}$  is the output of the second amplifier which uses  $V_{REF}$  to add an offset voltage to  $V_{IN}$  and feedback to add inverting gain. The transfer function for  $V_{OUT-}$  is Equation 2.

$$V_{OUT+} = V_{IN} \quad (1)$$

$$V_{OUT-} = V_{REF} \times \left( \frac{R_4}{R_3 + R_4} \right) \times \left( 1 + \frac{R_2}{R_1} \right) - V_{IN} \times \frac{R_2}{R_1} \quad (2)$$

The differential output signal,  $V_{DIFF}$ , is the difference between the two single-ended output signals,  $V_{OUT+}$  and  $V_{OUT-}$ . Equation 3 shows the transfer function for  $V_{DIFF}$ . By applying the conditions that  $R_1 = R_2$  and  $R_3 = R_4$ , the transfer function is simplified into Equation 6. Using this configuration, the maximum input signal is equal to the reference voltage and the maximum output of each amplifier is equal to the  $V_{REF}$ . The differential output range is  $2 \times V_{REF}$ . Furthermore, the common mode voltage will be one half of  $V_{REF}$  (see Equation 7).

$$V_{DIFF} = V_{OUT+} - V_{OUT-} = V_{IN} \times \left( 1 + \frac{R_2}{R_1} \right) - V_{REF} \times \left( \frac{R_4}{R_3 + R_4} \right) \left( 1 + \frac{R_2}{R_1} \right) \quad (3)$$

$$V_{OUT+} = V_{IN} \quad (4)$$

$$V_{OUT-} = V_{REF} - V_{IN} \quad (5)$$

$$V_{DIFF} = 2 \times V_{IN} - V_{REF} \quad (6)$$

$$V_{CM} = \left( \frac{V_{OUT+} + V_{OUT-}}{2} \right) = \frac{1}{2} V_{REF} \quad (7)$$

## Amplifier Selection

Linearity over the input range is key for good DC accuracy. The input common mode range and the output swing limitations determine the linearity. In general, an amplifier with rail-to-rail input and output swing is required. Bandwidth is a key concern for this design. Since the SGM5532 has a bandwidth of 8.5MHz, this circuit will only be able to process signals with frequencies of less than 8.5MHz.

## Passive Component Selection

Because the transfer function of  $V_{OUT-}$  is heavily reliant on resistors ( $R_1$ ,  $R_2$ ,  $R_3$ , and  $R_4$ ), use resistors with low tolerances to maximize performance and minimize error. This design used resistors with resistance values of 36k $\Omega$  with tolerances measured to be within 2%. But, if the noise of the system is a key parameter, the user can select smaller resistance values to keep the overall system noise low. This ensures that the noise from the resistors is lower than the amplifier noise.

LAYOUT

Layout Guidelines

For best operational performance of the device, use good PCB layout practices, including:

- Noise can propagate into analog circuitry through the power pins of the circuit as a whole and the operational amplifier. Bypass capacitors are used to reduce the coupled noise by providing low impedance power sources local to the analog circuitry.
- Connect low-ESR, 0.1µF ceramic bypass capacitors between each supply pin and ground, placed as close to the device as possible. A single bypass capacitor from +V<sub>S</sub> to ground is applicable for single-supply applications.
- Separate grounding for analog and digital portions of circuitry is one of the simplest and most-effective methods of noise suppression. One or more layers on multilayer PCBs are usually devoted to ground planes. A ground plane helps distribute heat and reduces EMI noise pickup. Make sure to physically separate digital and analog grounds, paying attention to the flow of the ground current.
- To reduce parasitic coupling, run the input traces as far away from the supply or output traces as possible.

better to cross the sensitive trace perpendicular as opposed to in parallel with the noisy trace.

- Place the external components as close to the device as possible. Keeping R<sub>F</sub> and R<sub>G</sub> close to the inverting input minimizes parasitic capacitance, as shown in Figure 3 and Figure 4.
- Keep the length of input traces as short as possible. Always remember that the input traces are the most sensitive part of the circuit.
- Consider a driven, low-impedance guard ring around the critical traces. A guard ring can significantly reduce leakage currents from nearby traces that are at different potentials.

Layout Example

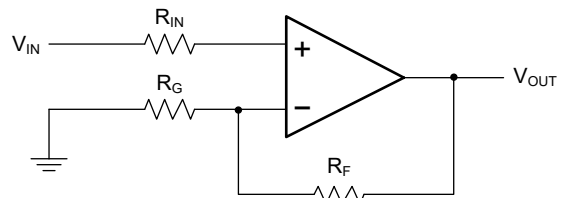

Figure 3. Operational Amplifier Schematic for Non-Inverting Configuration

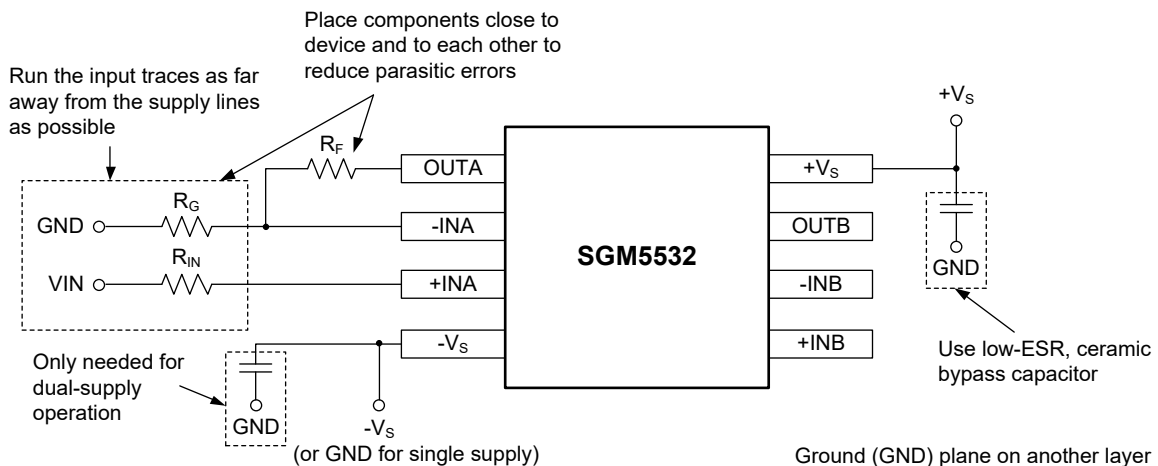

Figure 4. Operational Amplifier Board Layout for Non-Inverting Configuration

**REVISION HISTORY**

NOTE: Page numbers for previous revisions may differ from page numbers in the current version.

<b>APRIL 2018 – REV.A to REV.A.1</b>	<b>Page</b>
Updated Electrical Characteristics section .....	3

---

<b>Changes from Original (DECEMBER 2017) to REV.A</b>	<b>Page</b>
Changed from product preview to production data.....	All

---

PACKAGE OUTLINE DIMENSIONS

SOIC-8

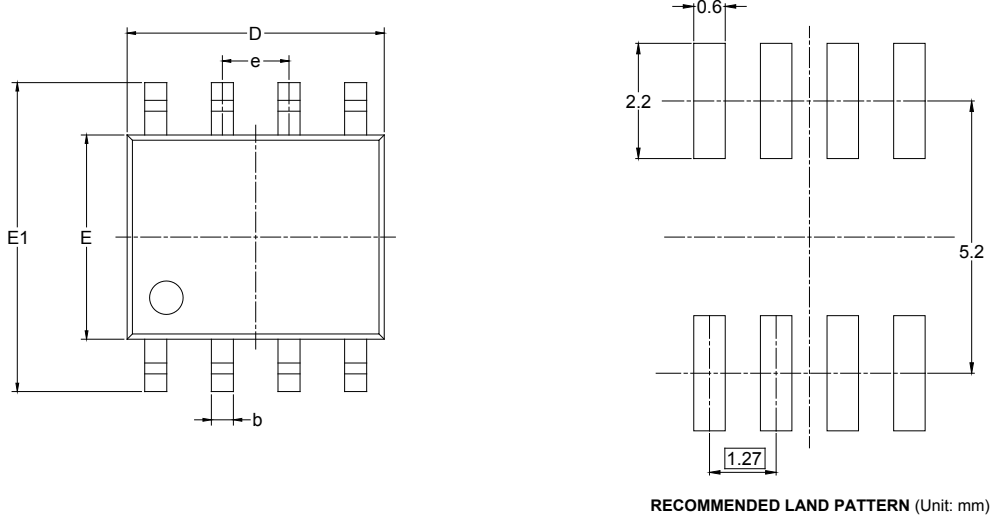

Symbol	Dimensions In Millimeters		Dimensions In Inches	
	MIN	MAX	MIN	MAX
A	1.350	1.750	0.053	0.069
A1	0.100	0.250	0.004	0.010
A2	1.350	1.550	0.053	0.061
b	0.330	0.510	0.013	0.020
c	0.170	0.250	0.006	0.010
D	4.700	5.100	0.185	0.200
E	3.800	4.000	0.150	0.157
E1	5.800	6.200	0.228	0.244
e	1.27 BSC		0.050 BSC	
L	0.400	1.270	0.016	0.050
$\theta$	0°	8°	0°	8°

# PACKAGE INFORMATION

## TAPE AND REEL INFORMATION

### REEL DIMENSIONS



### TAPE DIMENSIONS



NOTE: The picture is only for reference. Please make the object as the standard.

### KEY PARAMETER LIST OF TAPE AND REEL

Package Type	Reel Diameter	Reel Width W1 (mm)	A0 (mm)	B0 (mm)	K0 (mm)	P0 (mm)	P1 (mm)	P2 (mm)	W (mm)	Pin1 Quadrant
SOIC-8	13"	12.4	6.40	5.40	2.10	4.0	8.0	2.0	12.0	Q1

000001

# PACKAGE INFORMATION

## CARTON BOX DIMENSIONS



NOTE: The picture is only for reference. Please make the object as the standard.

## KEY PARAMETER LIST OF CARTON BOX

Reel Type	Length (mm)	Width (mm)	Height (mm)	Pizza/Carton
13"	386	280	370	5

DD0002

## X-ON Electronics

Largest Supplier of Electrical and Electronic Components

*Click to view similar products for [Operational Amplifiers - Op Amps](#) category:*

*Click to view products by [SGMICRO](#) manufacturer:*

Other Similar products are found below :

[430227FB](#) [UPC451G2-A](#) [UPC824G2-A](#) [LT1678IS8](#) [042225DB](#) [058184EB](#) [UPC822G2-A](#) [UPC258G2-A](#) [NCS5651MNTXG](#)  
[NCV33202DMR2G](#) [NJM324E](#) [NTE925](#) [5962-9080901MCA\\*](#) [AZV358MTR-G1](#) [AP4310AUMTR-AG1](#) [HA1630D02MMEL-E](#)  
[HA1630S01LPEL-E](#) [AZV358MMTR-G1](#) [SCY33178DR2G](#) [NJU77806F3-TE1](#) [NCV5652MUTWG](#) [NCV20034DR2G](#) [NTE778S](#) [NTE871](#)  
[NTE924](#) [NTE937](#) [MCP6V16UT-E/OT](#) [MCP6V17T-E/MS](#) [MCP6V19T-E/ST](#) [SCY6358ADR2G](#) [NCS20282FCTTAG](#) [LM4565FVT-GE2](#)  
[EL5420CRZ-T7A](#) [TSV772IQ2T](#) [TSV792IYST](#) [NJM2100M-TE1](#) [COS2262MR](#) [COS2252MR](#) [COS5532SRB](#) [COS2272MR](#) [LMV358MR](#)  
[COS6002MR](#) [LMV358SR](#) [LM358SR](#) [RC4580MM/TR](#) [HGV8544M/TR](#) [HGV8541M/TR](#) [HGV8634M/TR](#) [HGV8542M/TR](#)  
[HGV8544MT/TR](#)