



SGM8701

Micro-Power, CMOS Input, RRIO, 1.4V, Push-Pull Output Comparator

GENERAL DESCRIPTION

The SGM8701 is an ultra low power comparator with a typical power supply current of 300nA. It has the best-in-class power supply current versus propagation delay performance. The propagation delay is as low as 6 μ s with 100mV overdrive at 1.4V supply.

Designed to operate over a wide range of supply voltages, from 1.4V to 5.5V, with guaranteed operation at 1.4V, 2.5V and 5.0V, the SGM8701 is ideal for use in a variety of battery-powered applications. With rail-to-rail common mode voltage range, the SGM8701 is well suited for single-supply operation. Its small packages make this device ideal for use in handheld electronics and mobile phone applications.

Featuring a push-pull output stage, the SGM8701 allows for operation with absolute minimum power consumption when driving any capacitive or resistive load.

SGM8701 is available in Green SOT-23-5 and SC70-5 space-saving packages. It is rated over the -40°C to +85°C temperature range.

FEATURES

- **Ultra Low Power Consumption:**
300nA (TYP) at $V_S = 1.4V$
- **Wide Supply Voltage Range: 1.4V to 5.5V**
- **Propagation Delay: 6 μ s (TYP) at $V_S = 1.4V$**
- **Push-Pull Output Current Drive:**
19mA (TYP) at $V_S = 5V$
- **Rail-to-Rail Input**
- **-40°C to +85°C Operating Temperature Range**
- **Available in Green SOT-23-5 and SC70-5 Packages**

APPLICATIONS

RC Timers
Window Detectors
IR Receiver
Multivibrators
Alarm and Monitoring Circuits

SGM8701

Micro-Power, CMOS Input, RRIO, 1.4V, Push-Pull Output Comparator

PACKAGE/ORDERING INFORMATION

MODEL	PIN-PACKAGE	SPECIFIED TEMPERATURE RANGE	ORDERING NUMBER	PACKAGE MARKING	PACKAGE OPTION
SGM8701	SOT-23-5	-40°C to +85°C	SGM8701YN5G/TR	S59XX	Tape and Reel, 3000
	SC70-5	-40°C to +85°C	SGM8701YC5G/TR	S5AXX	Tape and Reel, 3000

NOTE: Order number and package marking are defined as the follow:

ORDER NUMBER

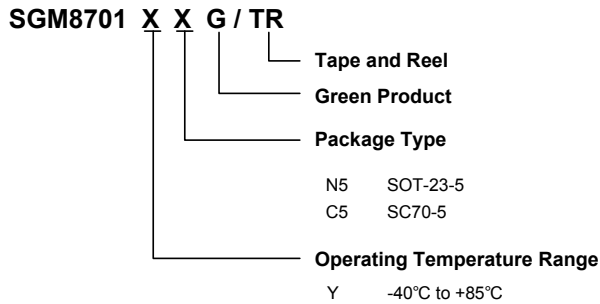

MARKING INFORMATION

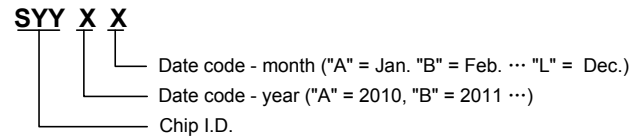

For example: S59BA (2011, January)

ABSOLUTE MAXIMUM RATINGS

Supply Voltage, +V _S to -V _S	6V
V _{IN} Differential.....	±2.5V
Voltage at Input/Output pins.....	(-V _S) - 0.3V to (+V _S) + 0.3V
Operating Temperature Range.....	-40°C to +85°C
Junction Temperature.....	150°C
Storage Temperature.....	-65°C to +150°C
Lead Temperature (soldering, 10s)	260°C

ESD Susceptibility

HBM.....	2000V
MM.....	400V

NOTE:

Stresses beyond those listed under "Absolute Maximum Ratings" may cause permanent damage to the device. These are stress ratings only, and functional operation of the device at these or any other conditions beyond those indicated in the operational sections of the specifications is not implied. Exposure to absolute maximum rating conditions for extended periods may affect device reliability.

PIN CONFIGURATIONS (TOP VIEW)

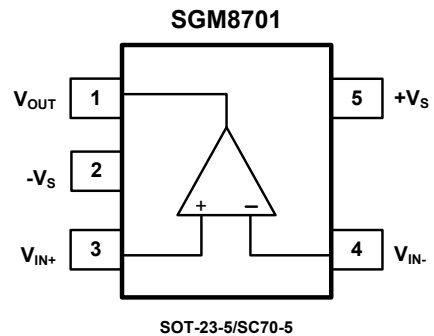

CAUTION

This integrated circuit can be damaged by ESD if you don't pay attention to ESD protection. SGMICRO recommends that all integrated circuits be handled with appropriate precautions. Failure to observe proper handling and installation procedures can cause damage. ESD damage can range from subtle performance degradation to complete device failure. Precision integrated circuits may be more susceptible to damage because very small parametric changes could cause the device not to meet its published specifications.

SGMICRO reserves the right to make any change in circuit design, specification or other related things if necessary without notice at any time. Please contact SGMICRO sales office to get the latest datasheet.

ELECTRICAL CHARACTERISTICS: $V_S = 1.4V$ (At $T_A = 25^\circ C$, $+V_S = 1.4V$, $-V_S = 0V$, $V_{CM} = +V_S/2$ and $V_O = -V_S$, unless otherwise noted.)

PARAMETER	SYMBOL	CONDITIONS	MIN	TYP	MAX	UNITS
Supply Current	I_S	$V_{CM} = 0.3V$		300	1000	nA
		$V_{CM} = 1.1V$		250	1000	
Input Offset Voltage	V_{OS}	$V_{CM} = 0V$	-3	0.5	3	mV
		$V_{CM} = 1.4V$	-3	0.5	3	
Input Offset Average Drift				2		$\mu V/^\circ C$
Common Mode Rejection Ratio	CMRR	V_{CM} Stepped from 0V to 0.3V		65		dB
		V_{CM} Stepped from 0.8V to 1.4V		75		
		V_{CM} Stepped from 0V to 1.4V		75		
Power Supply Rejection Ratio	PSRR	$V_S = 1.8V$ to $5.5V$, $V_{CM} = 0V$	66	95		dB
Large Signal Voltage Gain	A_{VO}			100		dB
Output Swing High	V_{OH}	$V_S = 1.8V$, $I_O = 500\mu A$	1.598	1.669		V
		$-40^\circ C \leq T_A \leq +85^\circ C$	1.581			
		$V_S = 1.8V$, $I_O = 1mA$	1.324	1.508		
		$-40^\circ C \leq T_A \leq +85^\circ C$	1.288			
Output Swing Low	V_{OL}	$V_S = 1.8V$, $I_O = -500\mu A$		82	112	mV
		$-40^\circ C \leq T_A \leq +85^\circ C$			127	
		$V_S = 1.8V$, $I_O = -1mA$		167	225	
		$-40^\circ C \leq T_A \leq +85^\circ C$			253	
Output Current	I_{OUT}	Source		0.7		mA
		Sink		2.0		
Propagation Delay (High to Low)		Overdrive = 10mV		12		μs
		Overdrive = 100mV		6		
Propagation Delay (Low to High)		Overdrive = 10mV		26		μs
		Overdrive = 100mV		17		
Rise Time	t_{Rise}	Overdrive = 10mV, $C_L = 30pF$, $R_L = 1M\Omega$		220		ns
		Overdrive = 100mV, $C_L = 30pF$, $R_L = 1M\Omega$		220		
Fall Time	t_{Fall}	Overdrive = 10mV, $C_L = 30pF$, $R_L = 1M\Omega$		155		ns
		Overdrive = 100mV, $C_L = 30pF$, $R_L = 1M\Omega$		155		

ELECTRICAL CHARACTERISTICS: $V_S = 2.5V$ (At $T_A = 25^\circ C$, $+V_S = 2.5V$, $-V_S = 0V$, $V_{CM} = +V_S/2$ and $V_O = -V_S$, unless otherwise noted.)

PARAMETER	SYMBOL	CONDITIONS	MIN	TYP	MAX	UNITS
Supply Current	I_S	$V_{CM} = 0.3V$		310		nA
		$V_{CM} = 2.2V$		260		
Input Offset Voltage	V_{OS}	$V_{CM} = 0V$		0.5		mV
		$V_{CM} = 2.5V$		0.5		
Input Offset Average Drift				2		$\mu V/^\circ C$
Common Mode Rejection Ratio	CMRR	V_{CM} Stepped from 0V to 1.4V		75		dB
		V_{CM} Stepped from 1.9V to 2.5V		80		
		V_{CM} Stepped from 0V to 2.5V		80		
Power Supply Rejection Ratio	PSRR	$V_S = 1.8V$ to $5.5V$, $V_{CM} = 0V$		95		dB
Large Signal Voltage Gain	A_{VO}			100		dB
Output Swing High	V_{OH}	$I_O = 500\mu A$		2.419		V
		$I_O = 1mA$		2.333		
Output Swing Low	V_{OL}	$I_O = -500\mu A$		66		mV
		$I_O = -1mA$		133		
Output Current	I_{OUT}	Source		5.3		mA
		Sink		7.7		
Propagation Delay (High to Low)		Overdrive = 10mV		12		μs
		Overdrive = 100mV		5		
Propagation Delay (Low to High)		Overdrive = 10mV		28		μs
		Overdrive = 100mV		19		
Rise Time	t_{Rise}	Overdrive = 10mV, $C_L = 30pF$, $R_L = 1M\Omega$		120		ns
		Overdrive = 100mV, $C_L = 30pF$, $R_L = 1M\Omega$		120		
Fall Time	t_{Fall}	Overdrive = 10mV, $C_L = 30pF$, $R_L = 1M\Omega$		85		ns
		Overdrive = 100mV, $C_L = 30pF$, $R_L = 1M\Omega$		70		

ELECTRICAL CHARACTERISTICS: $V_S = 5.0V$ (At $T_A = 25^\circ C$, $+V_S = 5.0V$, $-V_S = 0V$, $V_{CM} = +V_S/2$ and $V_O = -V_S$, unless otherwise noted.)

PARAMETER	SYMBOL	CONDITIONS	MIN	TYP	MAX	UNITS
Supply Current	I_S	$V_{CM} = 0.3V$		350	2000	nA
		$V_{CM} = 4.7V$		300	2000	
Input Offset Voltage	V_{OS}	$V_{CM} = 0V$	-3	0.5	3	mV
		$V_{CM} = 5V$	-3	0.5	3	
Input Offset Average Drift				2		$\mu V/^\circ C$
Common Mode Rejection Ratio	CMRR	V_{CM} Stepped from 0V to 3.9V		85		dB
		V_{CM} Stepped from 4.4V to 5.0V		85		
		V_{CM} Stepped from 0V to 5.0V		85		
Power Supply Rejection Ratio	PSRR	$V_S = 1.8V$ to $5.5V$, $V_{CM} = 0V$	66	95		dB
Large Signal Voltage Gain	A_{VO}			105		dB
Output Swing High	V_{OH}	$I_O = 500\mu A$	4.923	4.952		V
		$-40^\circ C \leq T_A \leq +85^\circ C$	4.916			
		$I_O = 1mA$	4.864	4.904		
		$-40^\circ C \leq T_A \leq +85^\circ C$	4.848			
Output Swing Low	V_{OL}	$I_O = -500\mu A$		52	80	mV
		$-40^\circ C \leq T_A \leq +85^\circ C$			90	
		$I_O = -1mA$		104	130	
		$-40^\circ C \leq T_A \leq +85^\circ C$			143	
Output Current	I_{OUT}	Source	14	18		mA
		$-40^\circ C \leq T_A \leq +85^\circ C$	12.1			
		Sink	15	19		
		$-40^\circ C \leq T_A \leq +85^\circ C$	12.9			
Propagation Delay (High to Low)		Overdrive = 10mV		13		μs
		Overdrive = 100mV		6		
Propagation Delay (Low to High)		Overdrive = 10mV		42		μs
		Overdrive = 100mV		33		
Rise Time	t_{Rise}	Overdrive = 10mV, $C_L = 30pF$, $R_L = 1M\Omega$		85		ns
		Overdrive = 100mV, $C_L = 30pF$, $R_L = 1M\Omega$		85		
Fall Time	t_{Fall}	Overdrive = 10mV, $C_L = 30pF$, $R_L = 1M\Omega$		70		ns
		Overdrive = 100mV, $C_L = 30pF$, $R_L = 1M\Omega$		60		

SGM8701

**Micro-Power, CMOS Input, RRIO, 1.4V,
Push-Pull Output Comparator**

SIMPLIFIED SCHEMATIC DIAGRAM

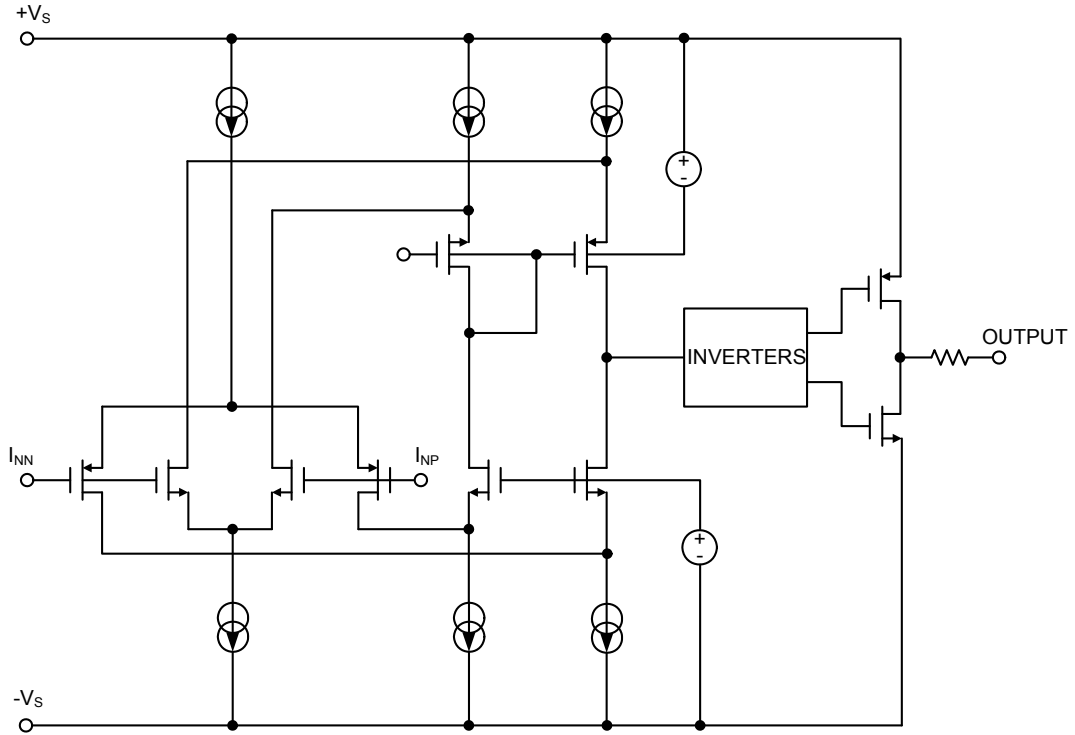

TYPICAL PERFORMANCE CHARACTERISTICS

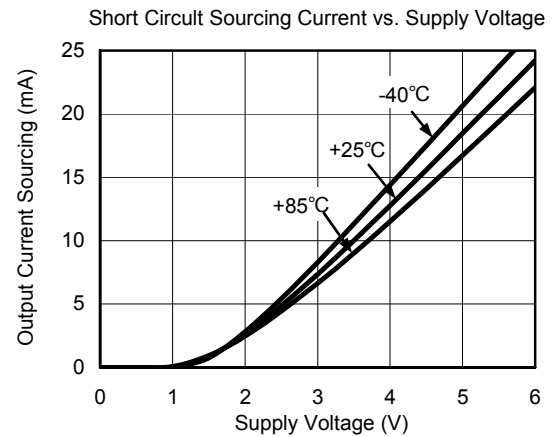
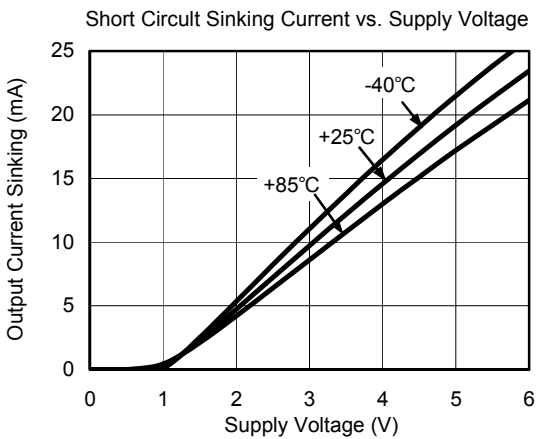
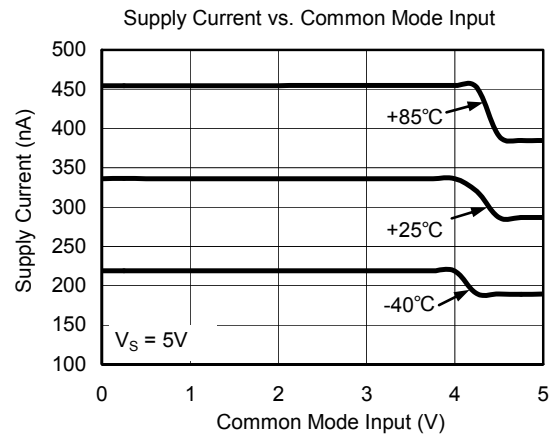
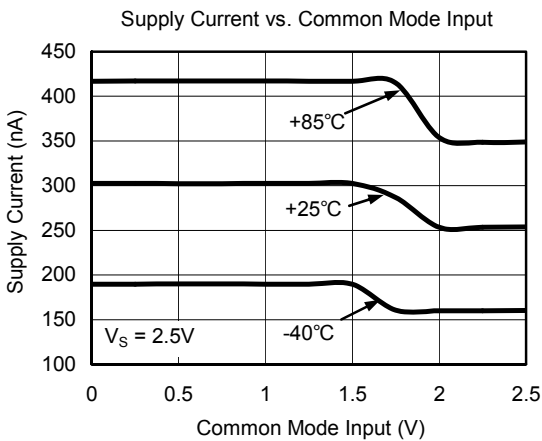
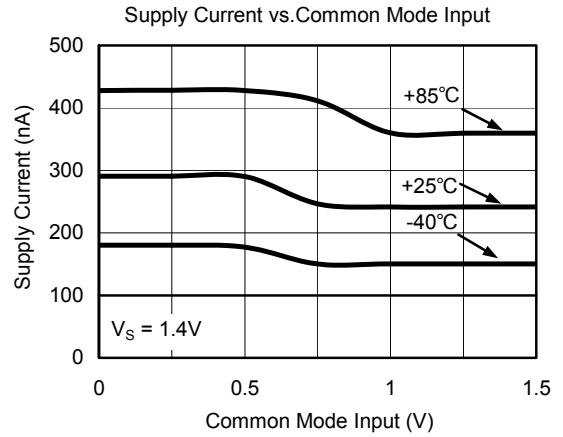
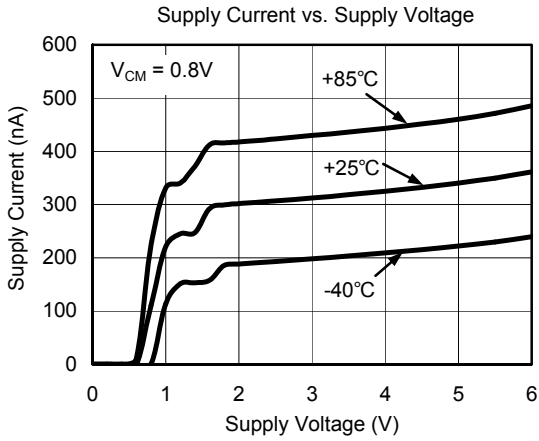

TYPICAL PERFORMANCE CHARACTERISTICS

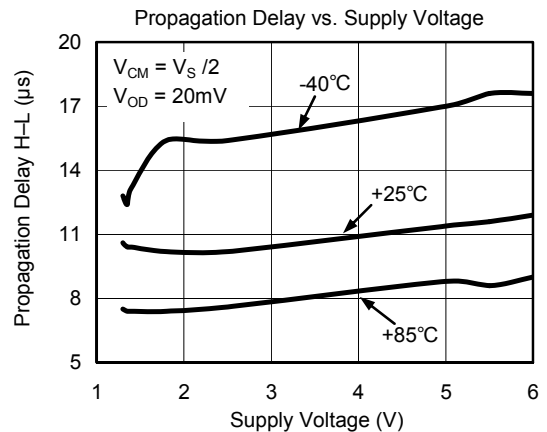
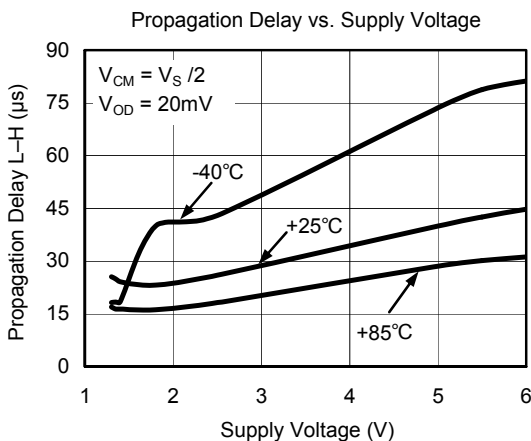
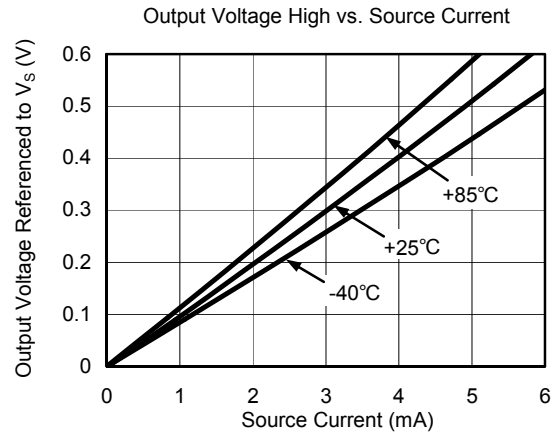
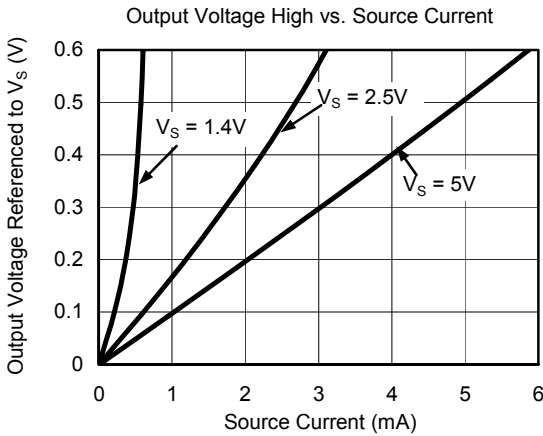
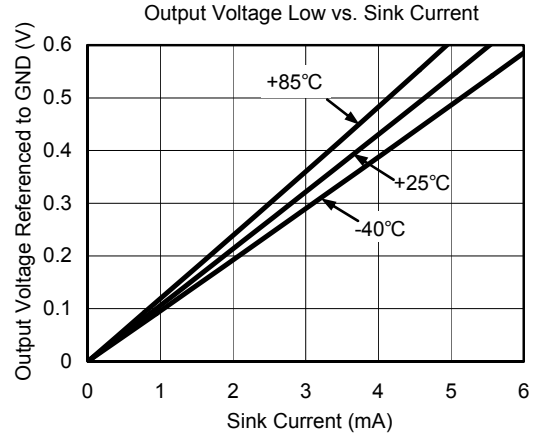
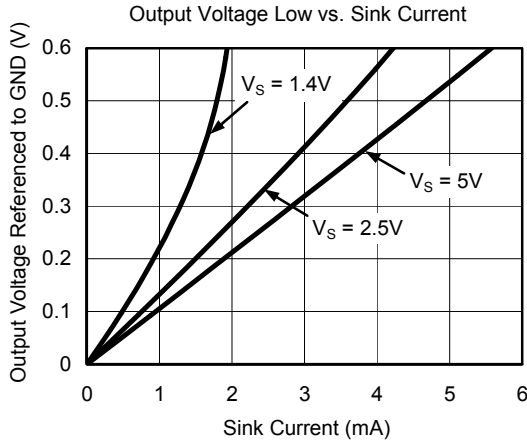

TYPICAL PERFORMANCE CHARACTERISTICS

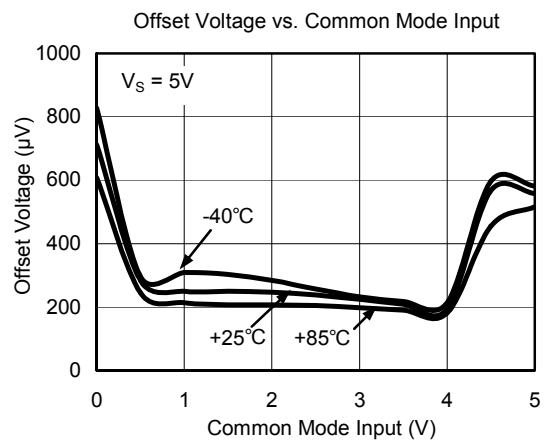
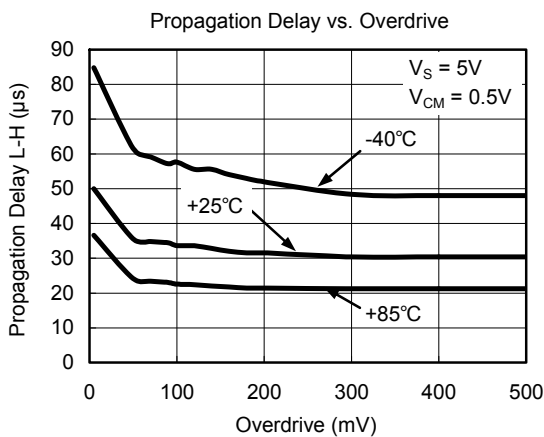
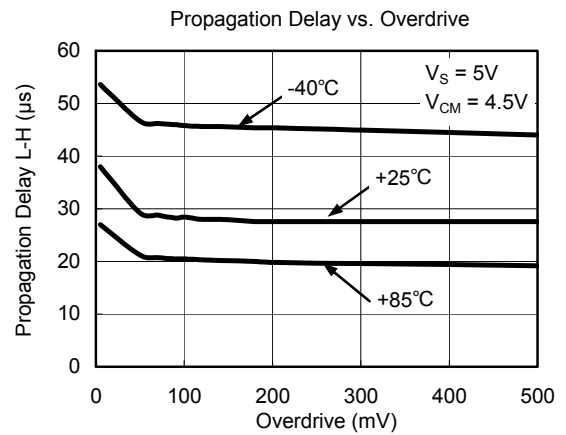
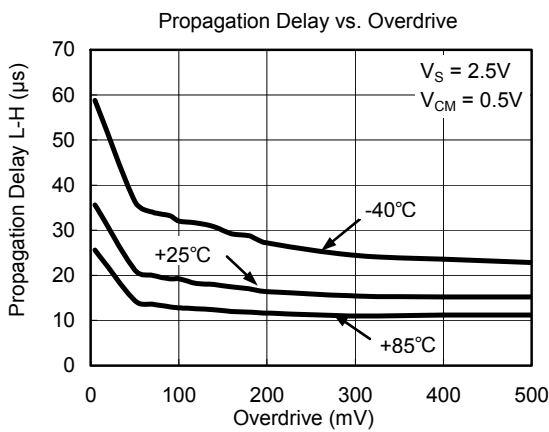
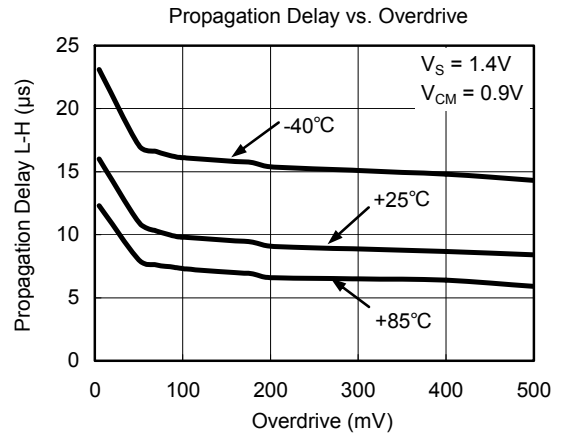
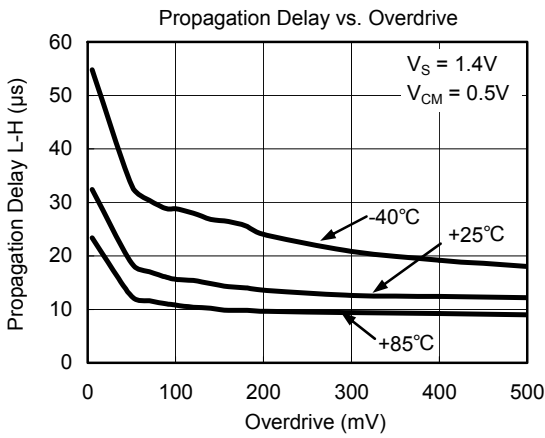

TYPICAL PERFORMANCE CHARACTERISTICS

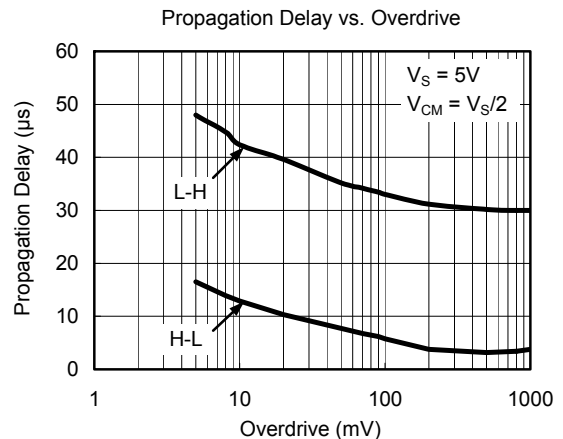
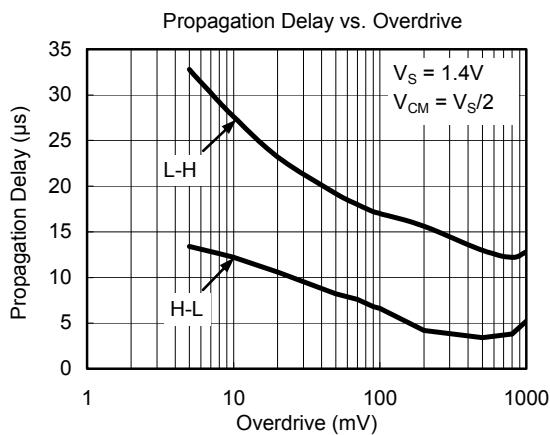
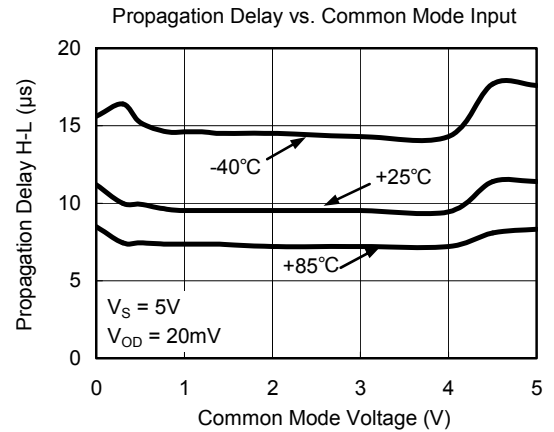
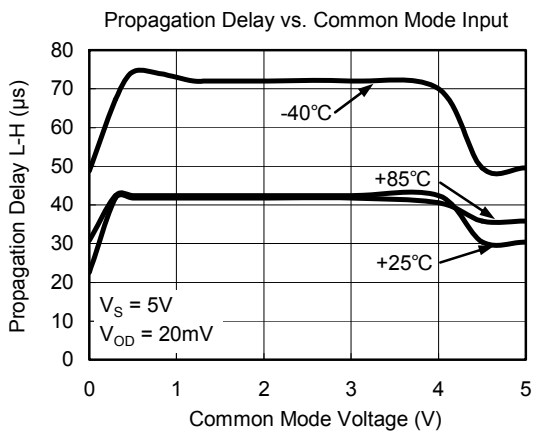
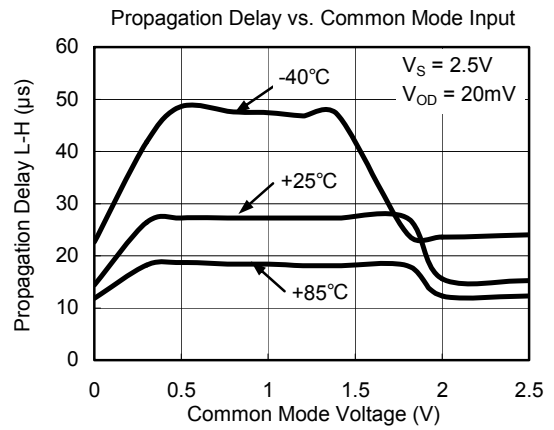
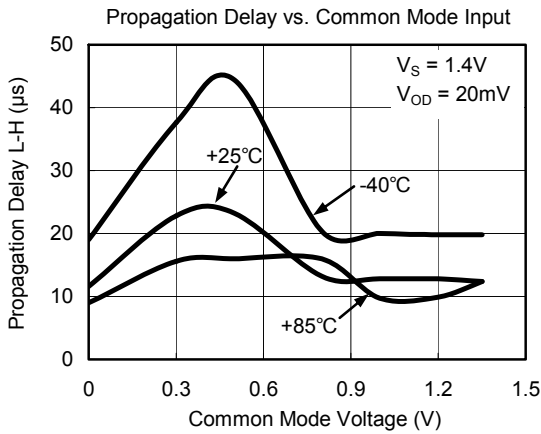

TYPICAL PERFORMANCE CHARACTERISTICS

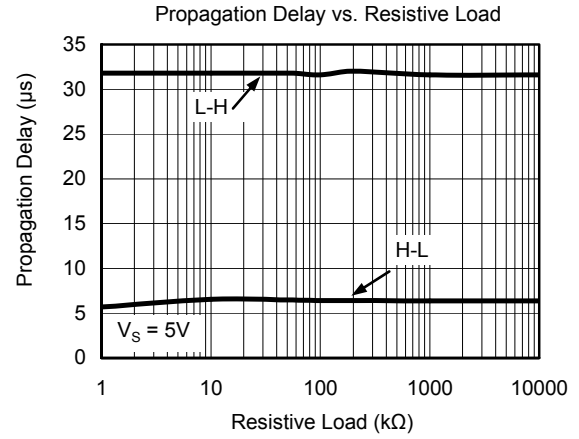
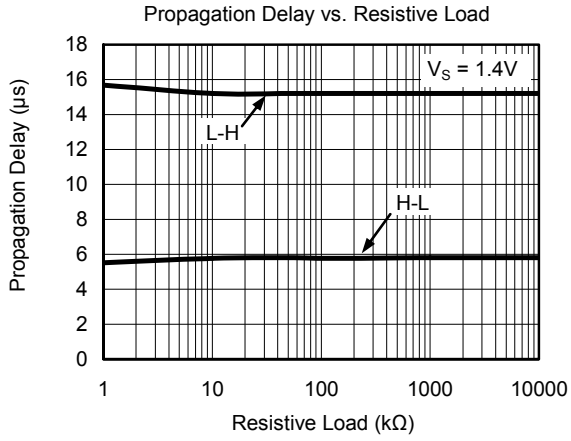

PACKAGE OUTLINE DIMENSIONS

SOT-23-5

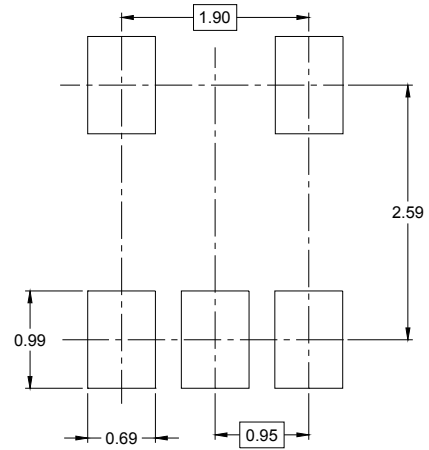
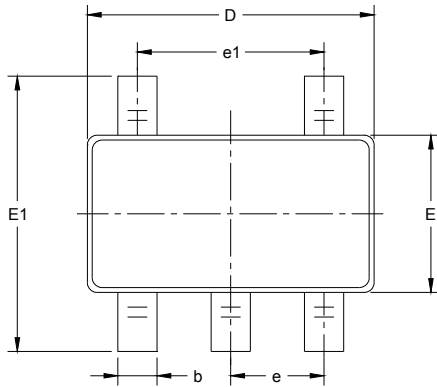

RECOMMENDED LAND PATTERN (Unit: mm)

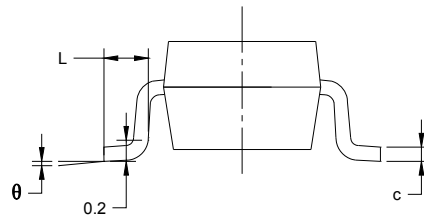
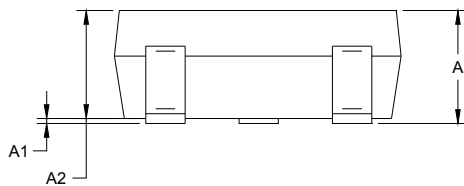

Symbol	Dimensions In Millimeters		Dimensions In Inches	
	MIN	MAX	MIN	MAX
A	1.050	1.250	0.041	0.049
A1	0.000	0.100	0.000	0.004
A2	1.050	1.150	0.041	0.045
b	0.300	0.500	0.012	0.020
c	0.100	0.200	0.004	0.008
D	2.820	3.020	0.111	0.119
E	1.500	1.700	0.059	0.067
E1	2.650	2.950	0.104	0.116
e	0.950 BSC		0.037 BSC	
e1	1.900 BSC		0.075 BSC	
L	0.300	0.600	0.012	0.024
θ	0°	8°	0°	8°

PACKAGE OUTLINE DIMENSIONS

SC70-5

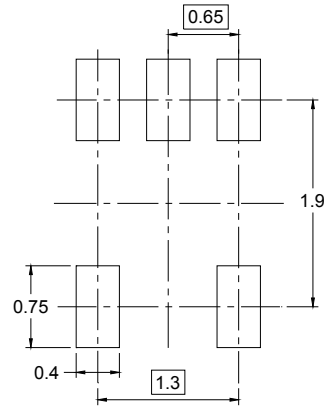
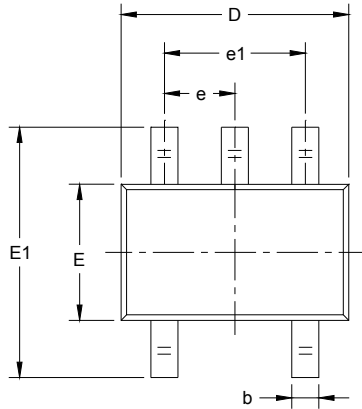

RECOMMENDED LAND PATTERN (Unit: mm)

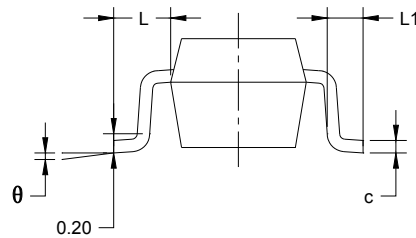
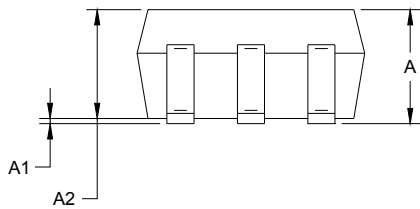

Symbol	Dimensions In Millimeters		Dimensions In Inches	
	MIN	MAX	MIN	MAX
A	0.900	1.100	0.035	0.043
A1	0.000	0.100	0.000	0.004
A2	0.900	1.000	0.035	0.039
b	0.150	0.350	0.006	0.014
c	0.080	0.150	0.003	0.006
D	2.000	2.200	0.079	0.087
E	1.150	1.350	0.045	0.053
E1	2.150	2.450	0.085	0.096
e	0.65 TYP		0.026 TYP	
e1	1.300 BSC		0.051 BSC	
L	0.525 REF		0.021 REF	
L1	0.260	0.460	0.010	0.018
θ	0°	8°	0°	8°

TAPE AND REEL INFORMATION

REEL DIMENSIONS

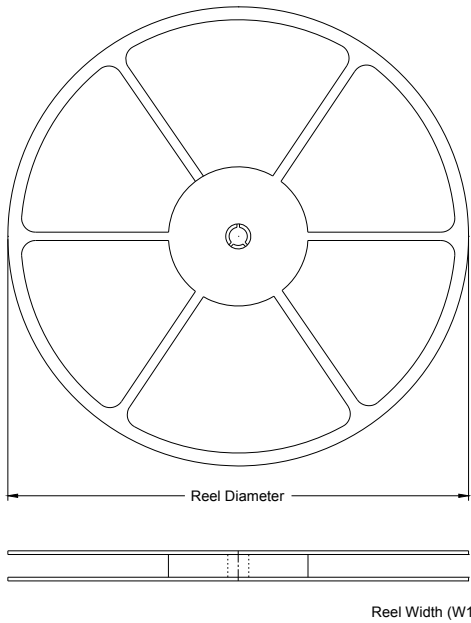

TAPE DIMENSIONS

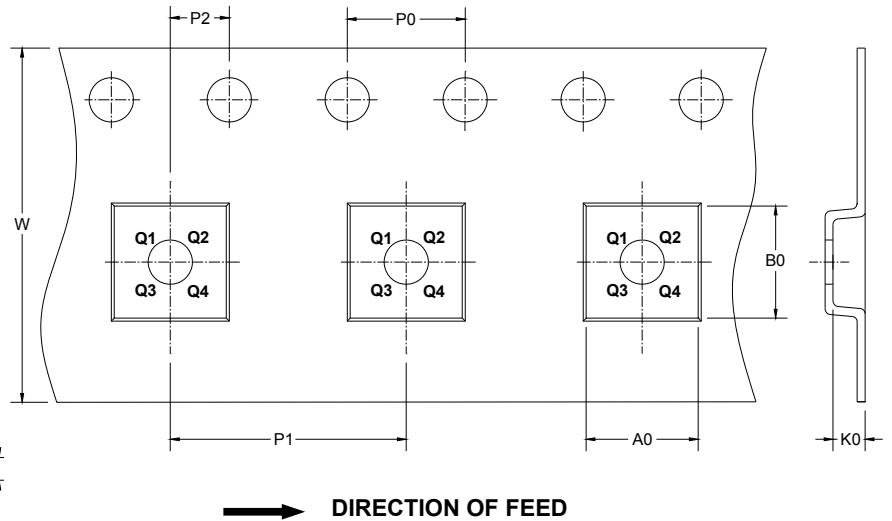

NOTE: The picture is only for reference. Please make the object as the standard.

KEY PARAMETER LIST OF TAPE AND REEL

Package Type	Reel Diameter	Reel Width W1 (mm)	A0 (mm)	B0 (mm)	K0 (mm)	P0 (mm)	P1 (mm)	P2 (mm)	W (mm)	Pin1 Quadrant
SOT-23-5	7"	9.5	3.2	3.2	1.4	4.0	4.0	2.0	8.0	Q3
SC70-5	7"	9.5	2.25	2.55	1.20	4.0	4.0	2.0	8.0	Q3

SGM8701

Micro-Power, CMOS Input, RRIO, 1.4V, Push-Pull Output Comparator

CARTON BOX DIMENSIONS

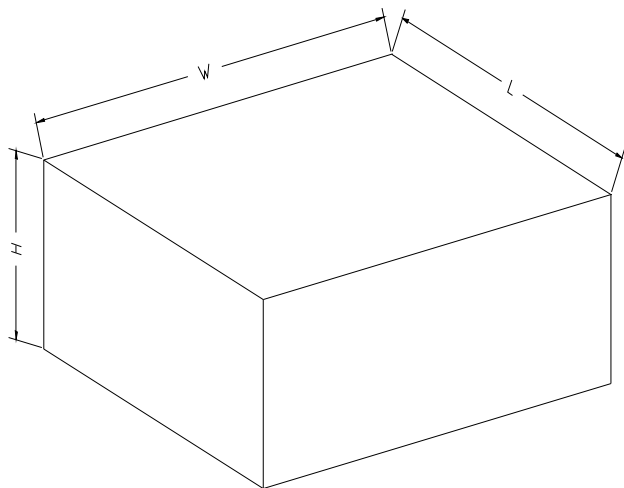

NOTE: The picture is only for reference. Please make the object as the standard.

KEY PARAMETER LIST OF CARTON BOX

Reel Type	Length (mm)	Width (mm)	Height (mm)	Pizza/Carton
7" (Option)	368	227	224	8
7"	442	410	224	18

X-ON Electronics

Largest Supplier of Electrical and Electronic Components

Click to view similar products for [Analog Comparators](#) category:

Click to view products by [SGMICRO](#) manufacturer:

Other Similar products are found below :

[SC2903VDR2G](#) [LM2901SNG](#) [LM339SNG](#) [LM393SNG](#) [NTE911](#) [LM339EDR2G](#) [NTE922](#) [NCX2200GMAZ](#) [LM2903F-E2](#)
[LT1720IS8#TRPBF](#) [NJM2903M-TE1](#) [MC10E1651FNG](#) [MCP6544-EP](#) [MCP6541UT-I/LT](#) [MCP6542T-E/MS](#) [BA2903FVM-TR](#) [TS882IQ2T](#)
[LM2901EDR2G](#) [LM2903SNG](#) [5962-8765901CA](#) [TS391SN2T1G](#) [LM111JG](#) [LM139ADT](#) [LM239APT](#) [TLV1704AIPW](#) [BA8391G-TR](#)
[MAX9144EUD+](#) [MIC842NYMT-T5](#) [BU7252FVM-TR](#) [NCS2200AMUT1G](#) [MAX975EUA+T](#) [M38510/10304BGA](#) [LTC1440IMS8#PBF](#)
[MIC842HYMT-TR](#) [TS3021HIYLT](#) [AZV331KSTR-G1](#) [LM2901QS14-13](#) [LT1720IDD#PBF](#) [TLV7011DPWR](#) [TC75S58F,LF](#)
[LT1394IS8#PBF](#) [S-89431ACMC-HBVT2U](#) [LM2903AQTH-13](#) [TLC3704MD](#) [TC75S59F,LF](#) [TC75W58FU,LF](#) [S-89431BCPH-H4DTFU](#)
[TL331SN4T3G](#) [TLV7021DPWR](#) [TC75W56FU,LF](#)