



N-channel 650V, 20A Power MOSFET

<p>Description The Power MOSFET is fabricated using the advanced planer VDMOS technology. The resulting device has low conduction resistance, superior switching performance and high avalanche energy.</p> <p>Features</p> <ul style="list-style-type: none"> ◆ Low $R_{DS(on)}$ ◆ Low gate charge (typ. $Q_g = 58.3 \text{ nC}$) ◆ 100% UIS tested ◆ RoHS compliant <p>Applications</p> <ul style="list-style-type: none"> ◆ Power factor correction. ◆ Switched mode power supplies. ◆ LED driver. 	<p>Product Summary</p> <table style="width: 100%; border-collapse: collapse;"> <tr> <td style="width: 30%;">V_{DSS}</td> <td>650V</td> </tr> <tr> <td>I_D</td> <td>20A</td> </tr> <tr> <td>$R_{DS(on),max}$</td> <td>0.5Ω</td> </tr> <tr> <td>$Q_{g,typ}$</td> <td>58.3 nC</td> </tr> </table> <div style="text-align: center; margin-top: 20px;"> <p>TO-220F</p> <p>N-Channel MOSFET</p> </div>	V_{DSS}	650V	I_D	20A	$R_{DS(on),max}$	0.5 Ω	$Q_{g,typ}$	58.3 nC
V_{DSS}	650V								
I_D	20A								
$R_{DS(on),max}$	0.5 Ω								
$Q_{g,typ}$	58.3 nC								

Absolute Maximum Ratings

Parameter	Symbol	Value	Unit
Drain-Source Voltage	V_{DSS}	650	V
Continuous drain current ($T_c=25^\circ\text{C}$) ($T_c = 100^\circ\text{C}$)	I_D	20	A
		12.5	A
Pulsed drain current ¹⁾	I_{DM}	80	A
Gate-Source voltage	V_{GSS}	± 30	V
Avalanche energy, single pulse ²⁾	E_{AS}	720	mJ
Peak diode recovery dv/dt ³⁾	dv/dt	5	V/ns
Power Dissipation TO-220F ($T_c = 25^\circ\text{C}$) Derate above 25°C	P_D	45	W
		0.36	W/ $^\circ\text{C}$
Power Dissipation TO-220 ($T_c = 25^\circ\text{C}$) Derate above 25°C	P_D	250	W
		2	W/ $^\circ\text{C}$
Operating junction and storage temperature range	T_J, T_{STG}	-55 to +150	$^\circ\text{C}$
Continuous diode forward current	I_S	20	A
Diode pulse current	$I_{S,pulse}$	80	A

Thermal Characteristics

Parameter	Symbol	Value		Unit
		TO-220F	TO-220	
Thermal resistance, Junction-to-case	$R_{\theta JC}$	2.78	0.5	$^\circ\text{C/W}$
Thermal resistance, Junction-to-ambient	$R_{\theta JA}$	62.5	40	$^\circ\text{C/W}$



Package Marking and Ordering Information

Device	Device Package	Marking	Units/Tube	Units/Real
BCT20N65	TO-220F	BCT20N65	50	

Electrical Characteristics

$T_c = 25^\circ\text{C}$ unless otherwise noted

Parameter	Symbol	Test Condition	Min.	Typ.	Max.	Unit
Static characteristics						
Drain-source breakdown voltage	BV_{DSS}	$V_{GS}=0\text{ V}, I_D=0.25\text{ mA}$	650	-	-	V
Gate threshold voltage	$V_{GS(th)}$	$V_{DS}=V_{GS}, I_D=0.25\text{ mA}$	2	-	4	V
Drain cut-off current	I_{DSS}	$V_{DS}=650\text{ V}, V_{GS}=0\text{ V},$ $T_J = 25^\circ\text{C}$ $T_J = 125^\circ\text{C}$	-	-	1 100	μA
Gate leakage current, Forward	I_{GSSF}	$V_{GS}=30\text{ V}, V_{DS}=0\text{ V}$	-	-	100	nA
Gate leakage current, Reverse	I_{GSSR}	$V_{GS}=-30\text{ V}, V_{DS}=0\text{ V}$	-	-	-100	nA
Drain-source on-state resistance	$R_{DS(on)}$	$V_{GS}=10\text{ V}, I_D=10\text{ A}$	-	0.42	0.5	Ω
Dynamic characteristics						
Input capacitance	C_{iss}	$V_{DS}=25\text{ V}, V_{GS}=0\text{ V},$ $f = 1\text{ MHz}$	-	2962	-	pF
Output capacitance	C_{oss}		-	266	-	
Reverse transfer capacitance	C_{rss}		-	18	-	
Turn-on delay time	$t_{d(on)}$	$V_{DD} = 325\text{ V}, I_D = 20\text{ A}$ $R_G = 10\ \Omega, V_{GS}=15\text{ V}$	-	18.8	-	ns
Rise time	t_r		-	43.4	-	
Turn-off delay time	$t_{d(off)}$		-	98.2	-	
Fall time	t_f		-	16.9	-	
Gate charge characteristics						
Gate to source charge	Q_{gs}	$V_{DD}=520\text{ V}, I_D=20\text{ A},$ $V_{GS}=0\text{ to }10\text{ V}$	-	16.7	-	nC
Gate to drain charge	Q_{gd}		-	19.3	-	
Gate charge total	Q_g		-	58.3	-	
Gate plateau voltage	$V_{plateau}$		-	5	-	V
Reverse diode characteristics						
Diode forward voltage	V_{SD}	$V_{GS}=0\text{ V}, I_F=20\text{ A}$	-	-	1.5	V
Reverse recovery time	t_{rr}	$V_R=325\text{ V}, I_F=20\text{ A}$ $dI_F/dt=100\text{ A}/\mu\text{s}$	-	492.8	-	ns
Reverse recovery charge	Q_{rr}		-	7.46	-	μC
Peak reverse recovery current	I_{rm}		-	30.3	-	A

Notes:

1. Pulse width limited by maximum junction temperature.
2. $L=10\text{mH}, I_{AS} = 12\text{A},$ Starting $T_J = 25^\circ\text{C}.$
3. $I_{SD} = 20\text{A}, di/dt \leq 100\text{A}/\mu\text{s}, V_{DD} \leq BV_{DS},$ Starting $T_J = 25^\circ\text{C}.$



Electrical Characteristics Diagrams

Figure 1. Typical Output Characteristics

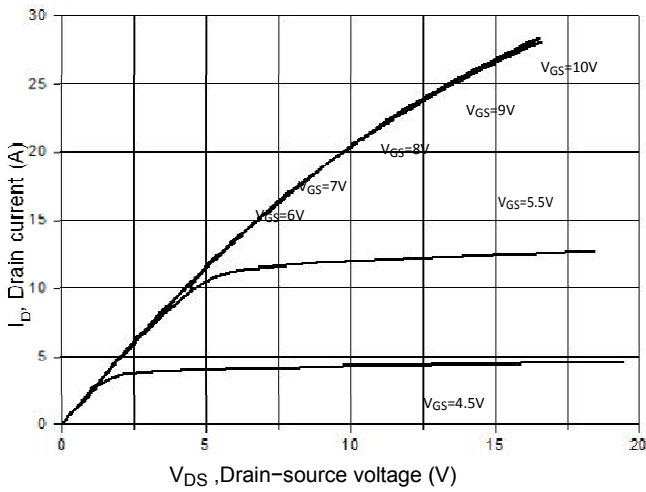

Figure 2. Transfer Characteristics

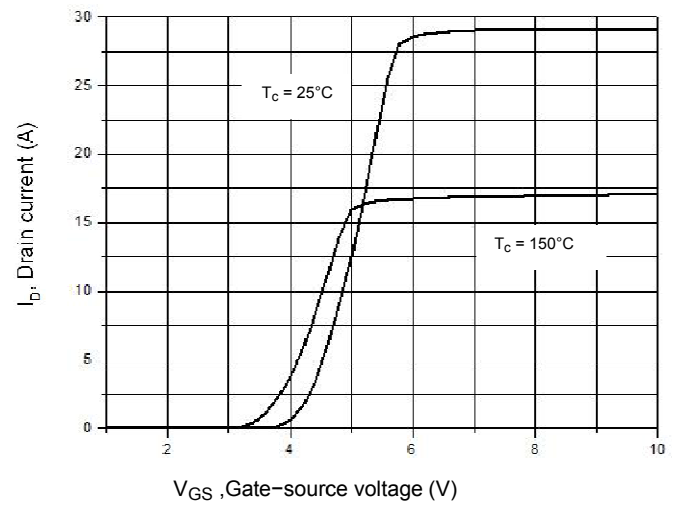

Figure 3. On-Resistance Variation vs. Drain Current

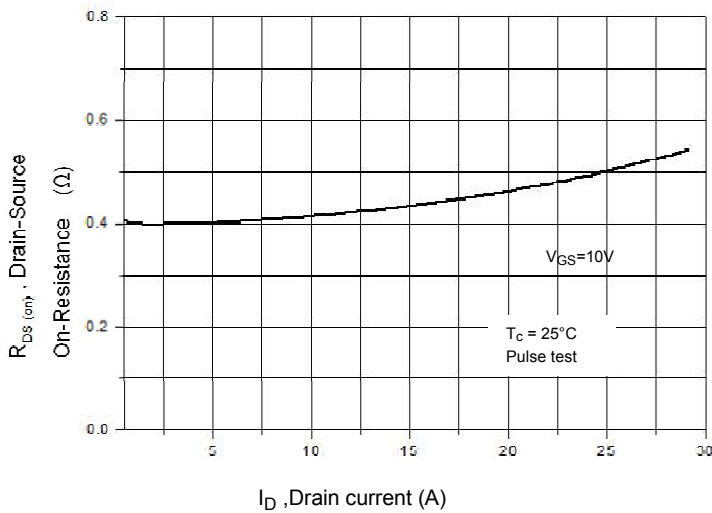

Figure 4. Threshold Voltage vs. Temperature

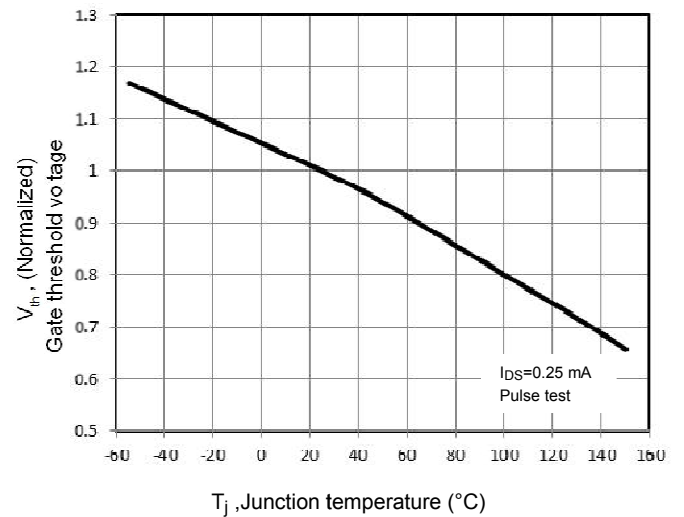

Figure 5. Breakdown Voltage vs. Temperature

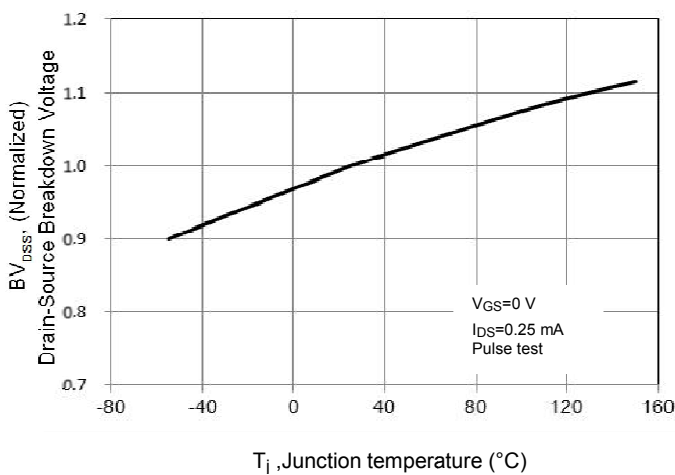

Figure 6. On-Resistance vs. Temperature

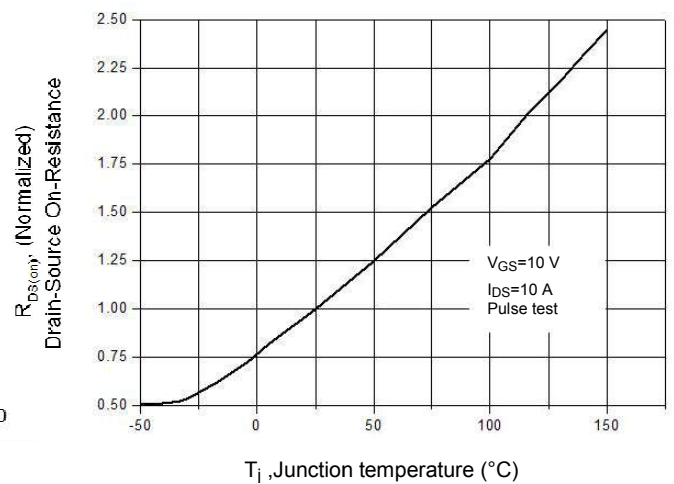



Figure 7. Capacitance Characteristics

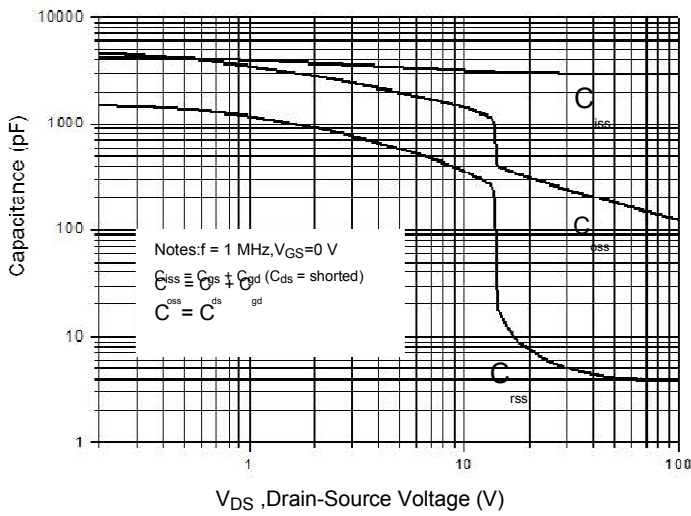

Figure 8. Gate Charge Characteristics

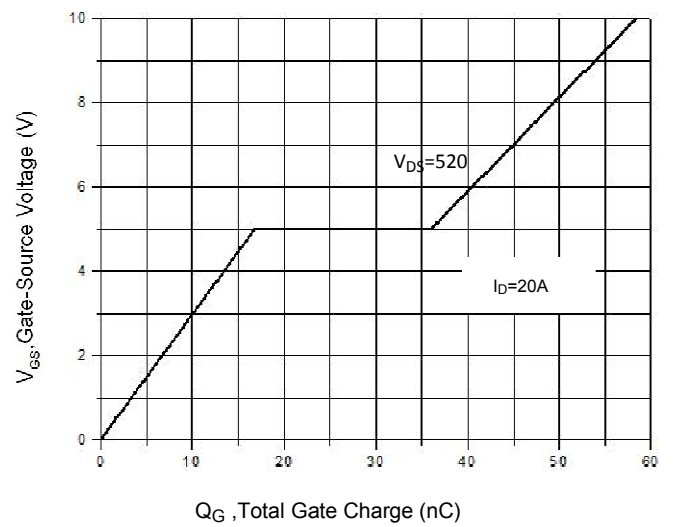

Figure 9. Maximum Safe Operating Area TO-220F

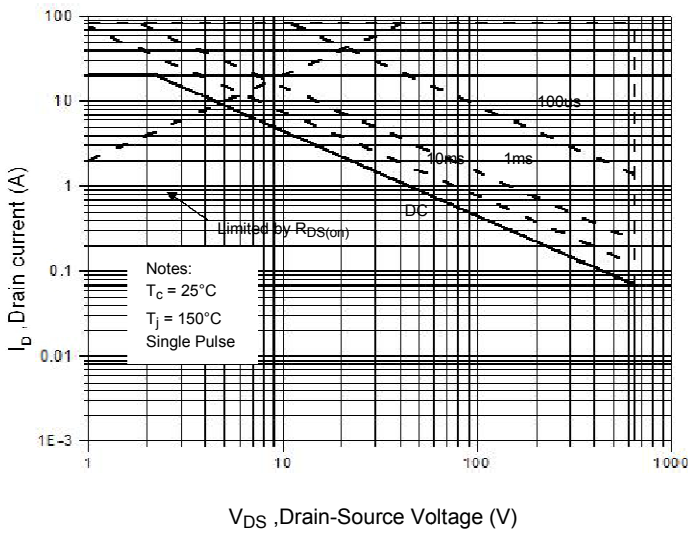

Figure 10. Maximum Safe Operating Area TO- 220

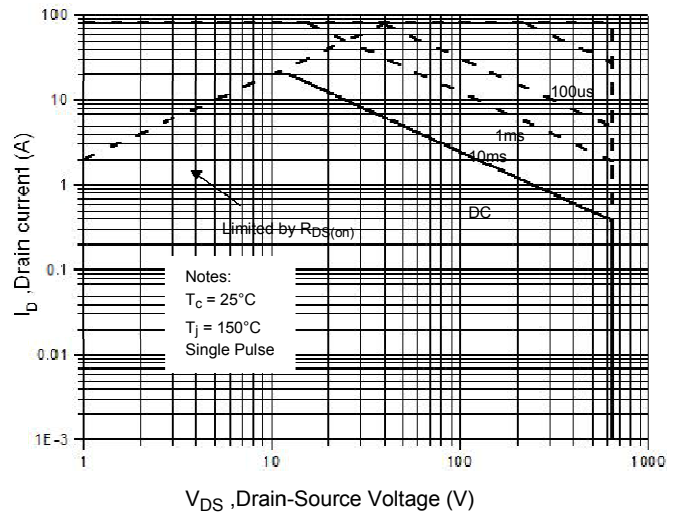

Figure 11. Power Dissipation vs. Temperature TO-220F

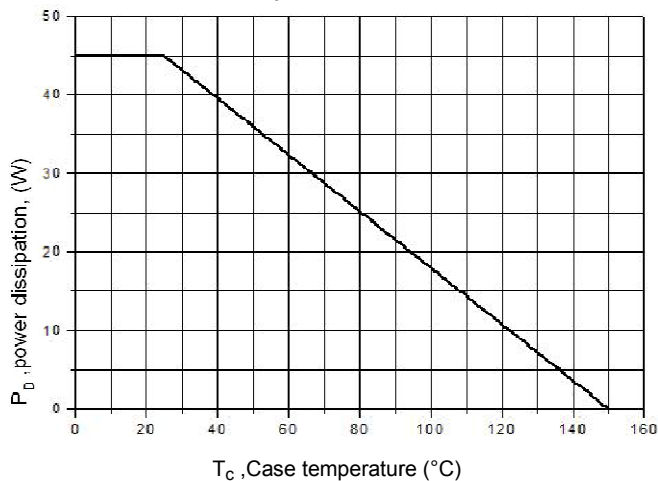

Figure 12. Power Dissipation vs. Temperature TO- 220

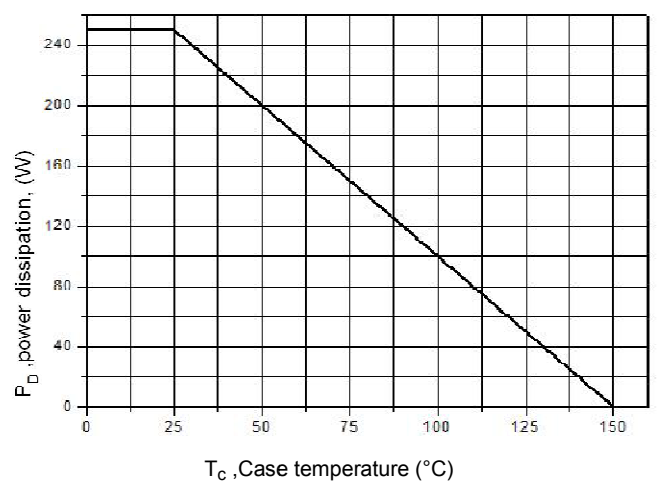



Figure 13. Continuous Drain Current vs. Temperature

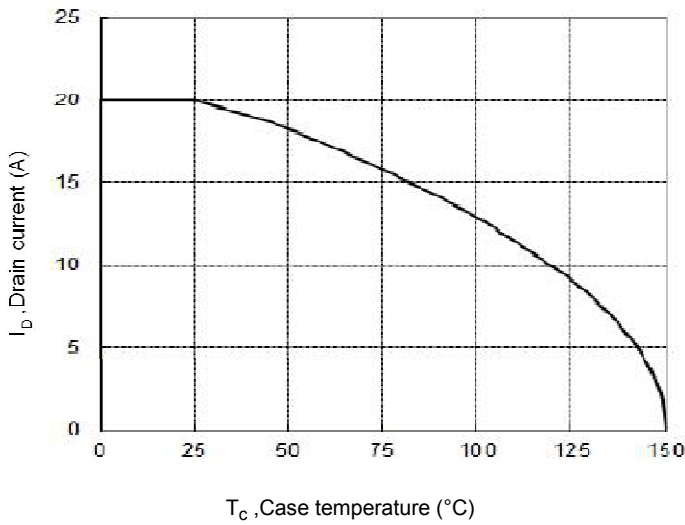

Figure 14. Body Diode Transfer Characteristics

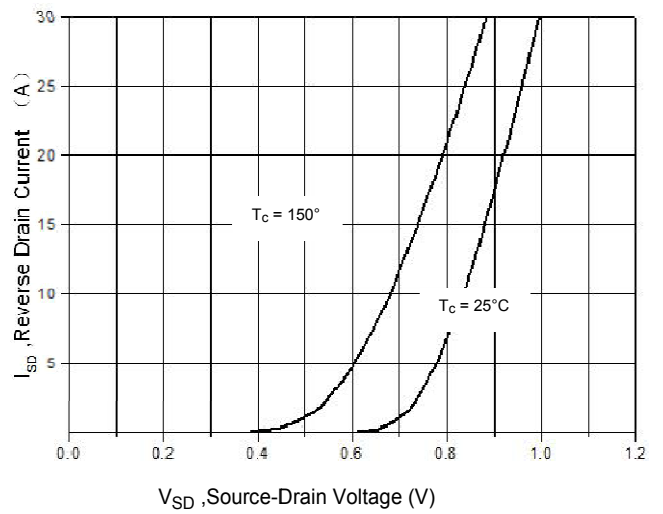

Figure 15 Transient Thermal Impedance, Junction to Case, TO-220F

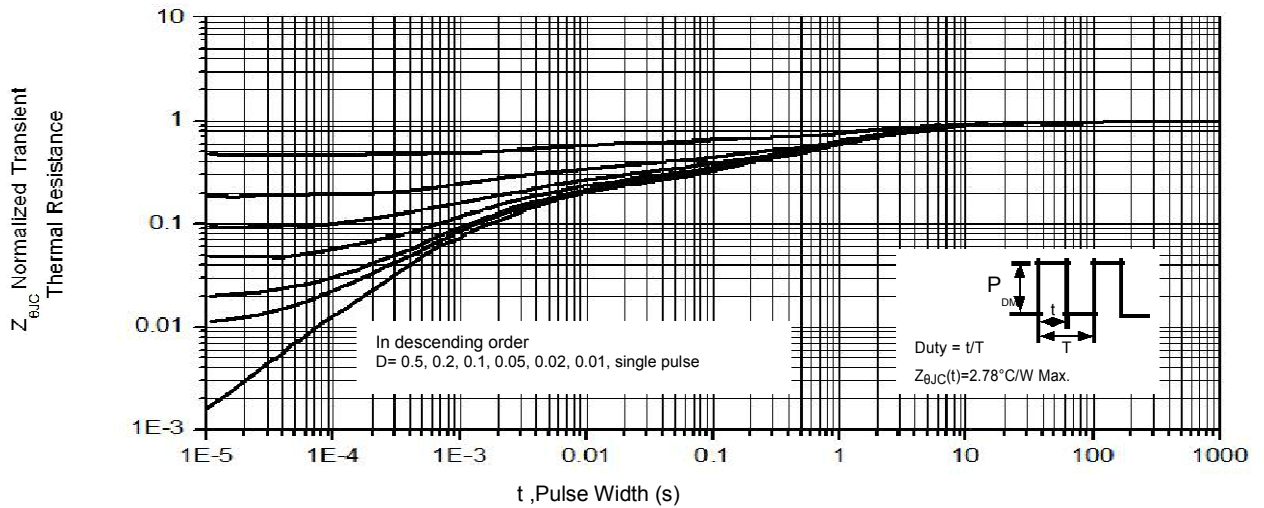
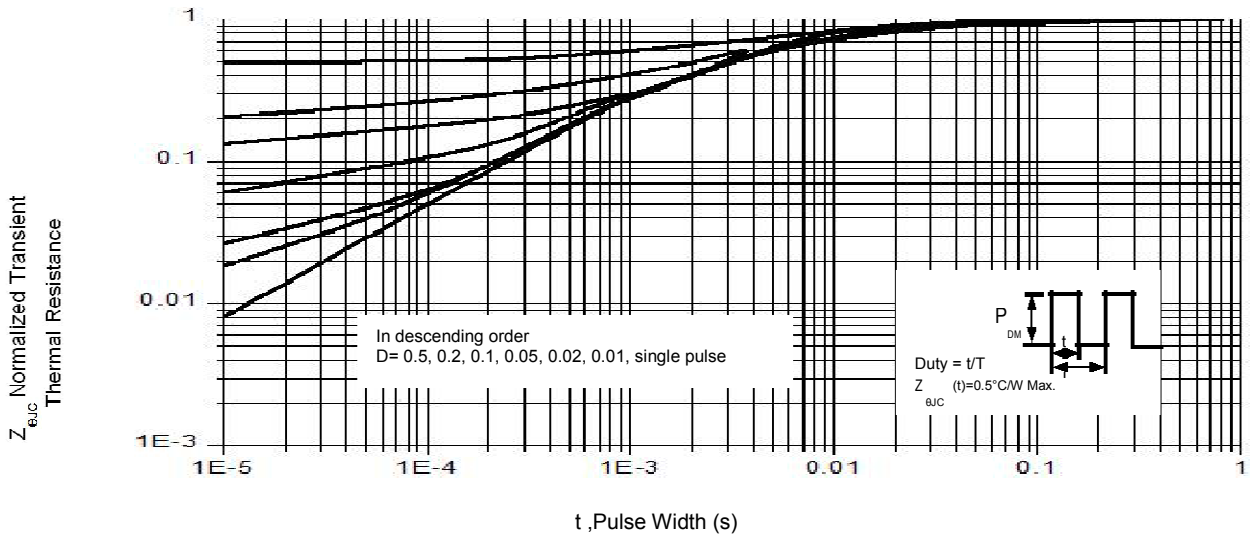
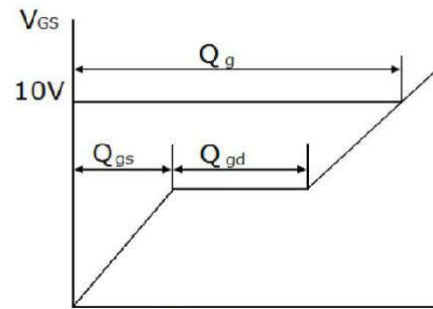
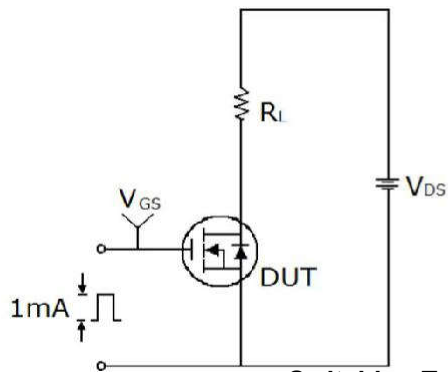

Figure 16. Transient Thermal Impedance, Junction to Case, TO-220





Gate Charge Test Circuit & Waveform



Switching Test Circuit & Waveforms

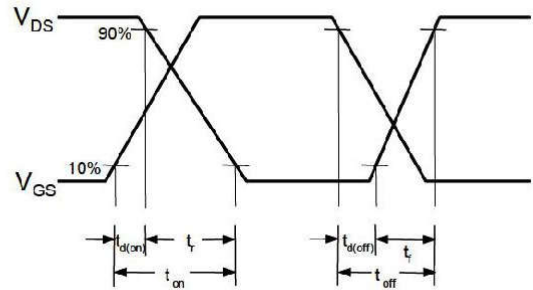
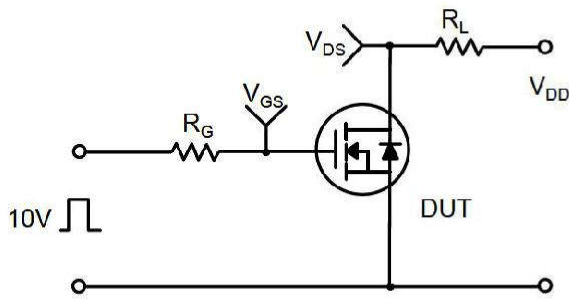

Unclamped Inductive Switching Test Circuit & Waveforms

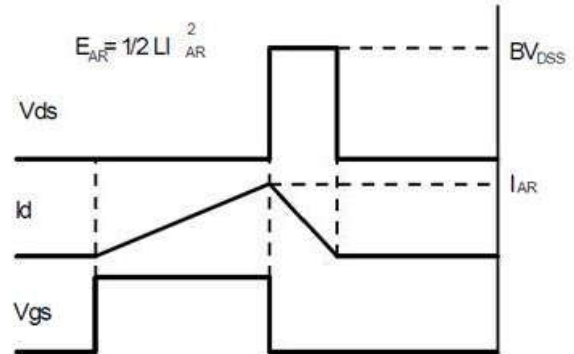
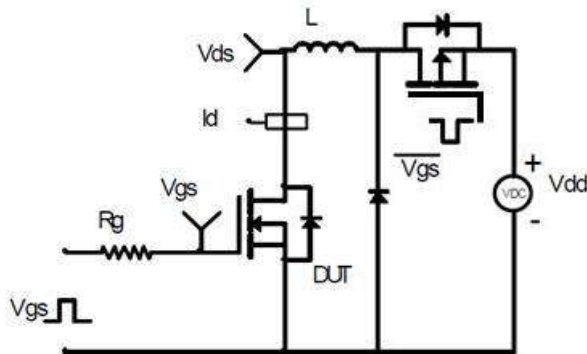



Mechanical Dimensions for TO-220F

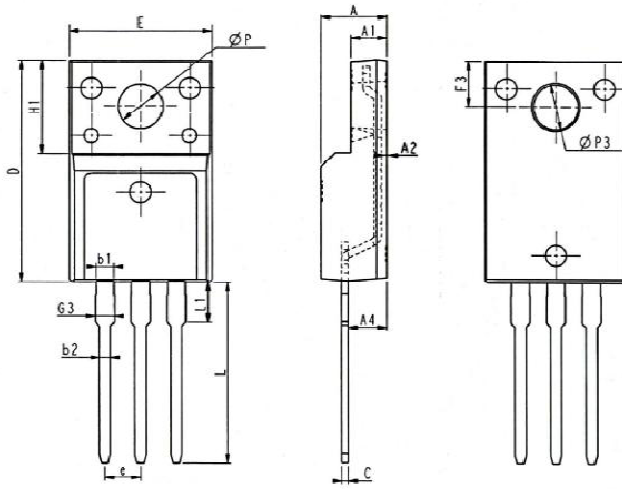

COMMON DIMENSIONS						
SYMBOL	MM			INCH		
	MIN	NOM	MAX	MIN	NOM	MAX
E	9.96	10.16	10.36	0.392	0.400	0.408
A	4.50	4.70	4.90	0.177	0.185	0.193
A1	2.34	2.54	2.74	0.092	0.100	0.108
A2	0.30	0.45	0.60	0.012	0.002	0.024
A4	2.65	2.76	2.96	0.104	0.109	0.117
C	0.40	0.50	0.65	0.016	0.020	0.026
D	15.57	15.87	16.17	0.613	0.625	0.637
H1	6.70REF			0.264REF		
e	2.54BSC			0.1BSC		
ØP	3.03	3.18	3.38	0.119	0.125	0.133
L	12.68	12.98	13.28	0.499	0.511	0.523
L1	2.88	3.03	3.18	0.113	0.119	0.125
ØP3	3.15REF			0.124REF		
F3	3.15	3.30	3.45	0.124	0.130	0.136
G3	1.25	1.35	1.55	0.049	0.053	0.061
b1	1.18	1.28	1.43	0.046	0.050	0.056
b2	0.70	0.80	0.95	0.028	0.031	0.037

TO-220F Part Marking Information

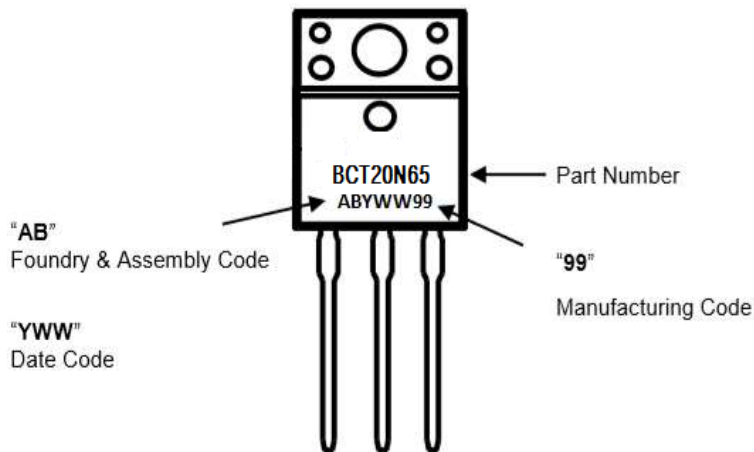

X-ON Electronics

Largest Supplier of Electrical and Electronic Components

Click to view similar products for [MOSFET](#) category:

Click to view products by [Shandong Baocheng](#) manufacturer:

Other Similar products are found below :

[IRFD120](#) [JANTX2N5237](#) [2SK2267\(Q\)](#) [BUK455-60A/B](#) [TK100A10N1,S4X\(S](#) [MIC4420CM-TR](#) [VN1206L](#) [NDP4060](#) [SI4482DY](#)
[IRS2092STRPBF-EL](#) [IPS70R2K0CEAKMA1](#) [TK31J60W5,S1VQ\(O](#) [TK31J60W,S1VQ\(O](#) [TK16J60W,S1VQ\(O](#) [2SK2614\(TE16L1,Q\)](#)
[DMN1017UCP3-7](#) [EFC2J004NUZTDG](#) [P85W28HP2F-7071](#) [DMN1053UCP4-7](#) [NTE2384](#) [DMC2700UDMQ-7](#) [DMN2080UCB4-7](#)
[DMN61D9UWQ-13](#) [US6M2GTR](#) [DMN31D5UDJ-7](#) [DMP22D4UFO-7B](#) [IPS60R3K4CEAKMA1](#) [DMN1006UCA6-7](#) [DMN16M9UCA6-7](#)
[STF5N65M6](#) [IRF40H233XTMA1](#) [STU5N65M6](#) [DMN6022SSD-13](#) [DMN13M9UCA6-7](#) [DMTH10H4M6SPS-13](#) [IPS60R360PFD7SAKMA1](#)
[DMN2990UFB-7B](#) [SSM3K35CT,L3F](#) [IPLK60R1K0PFD7ATMA1](#) [2N7002W-G](#) [MCAC30N06Y-TP](#) [IPWS65R035CFD7AXKSA1](#)
[MCQ7328-TP](#) [SSM3J143TU,LXHF](#) [DMN12M3UCA6-7](#) [PJMF280N65E1_T0_00201](#) [PJMF380N65E1_T0_00201](#)
[PJMF280N60E1_T0_00201](#) [PJMF600N65E1_T0_00201](#) [PJMF900N65E1_T0_00201](#)