



GBU4005 thru GBU410

4.0 A Single-Phase Silicon Bridge Rectifier Rectifier Reverse Voltage 50 to 1000V

Features

- Ideal for printed circuit board mounting
- This series is UL listed under the Recognized Component Index, file number E142814
- The plastic material used carries Underwriters Laboratory flammability recognition 94V-0
- Built-in printed circuit board stand-offs
- High case dielectric strength
- High temperature soldering guaranteed 260°C /5 seconds at 5 lbs (2.3kg) tension

Mechanical Data

Case: Reliable low cost construction utilizing molded plastic technique

Terminals: Plated leads solderable per MIL-STD-202, Method 208

Mounting Position: Any

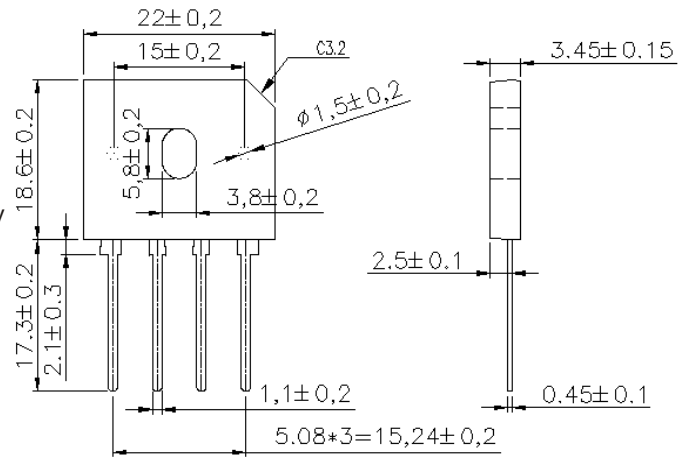

Dimensions in inches and (millimeters)

Maximum Ratings & Thermal Characteristics

Rating at 25°C ambient temperature unless otherwise specified, Resistive or Inductive load, 60 Hz.
For Capacitive load derate current by 20%.

Parameter	Symbol	GBU 4005	GBU 401	GBU 402	GBU 404	GBU 406	GBU 408	GBU 410	unit
Maximum repetitive peak reverse voltage	VRRM	50	100	200	400	600	800	1000	V
Maximum RMS bridge input voltage	VRMS	35	70	140	280	420	560	700	V
Maximum DC blocking voltage	VDC	50	100	200	400	600	800	1000	V
Maximum average forward rectified output current at TC=100°C (with heatsink)	IF(AV)	4.0							A
Peak forward surge current single sine-wave superimposed on rated load (JEDEC Method)	IFSM	90							A
Rating for fusing (t<8.3ms)	I ² t	33							A ² sec
Operating junction and storage temperature range	TJ, TSTG	-55 to + 150							°C

Electrical Characteristics

Rating at 25°C ambient temperature unless otherwise specified. Resistive or Inductive load, 60Hz.
For Capacitive load derate by 20 %.

Parameter	Symbol	GBU 4005	GBU 401	GBU 402	GBU 404	GBU 406	GBU 408	GBU 410	Unit
Maximum instantaneous forward voltage drop per leg at 4.0A	VF	1.1							V
Maximum DC reverse current at rated TA =25°C DC blocking voltage per element TA =125°C	IR	10 500							μA

Notes: (1) Thermal resistance from Junction to Ambient on P.C. board mounting.

Rating and Characteristic Curves ($T_A=25^{\circ}\text{C}$ Unless otherwise noted)

GBU4005 thru GBU410

Fig. 1 Derating Curve for Output Rectified Current

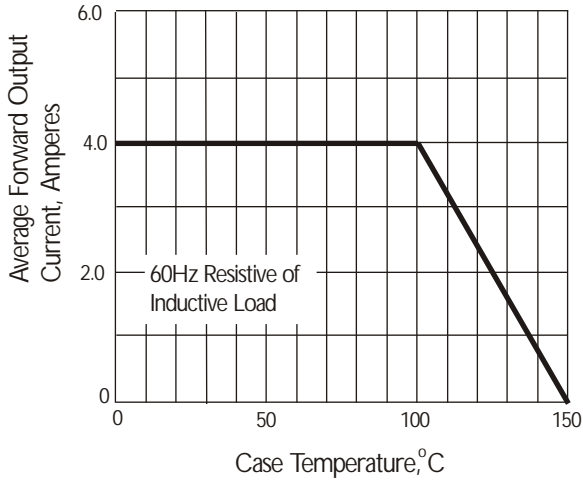

Fig. 2 Maximum Non-repetitive Peak Forward Surge Current

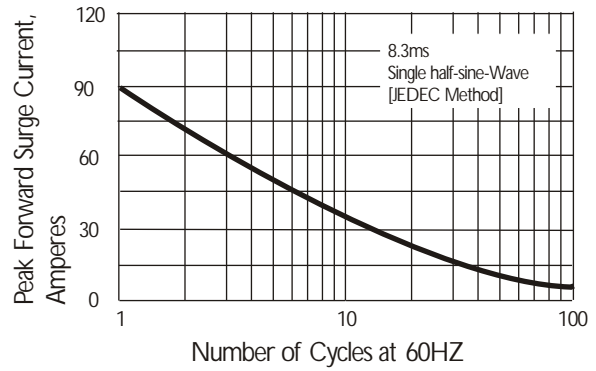

Fig. 3 Typical Instantaneous Forward Characteristics

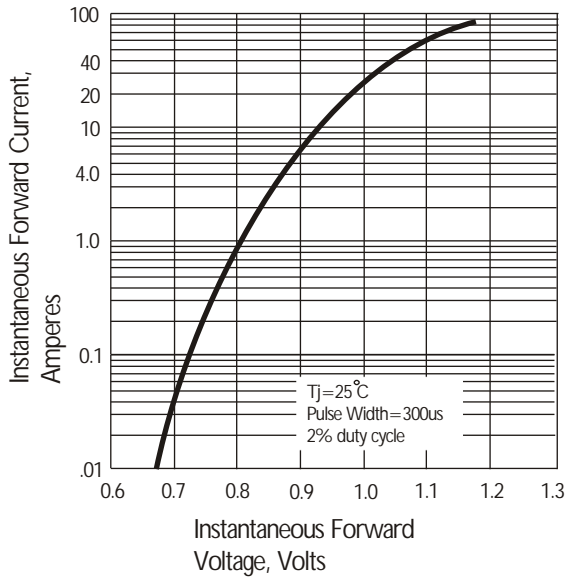

Fig. 4 Typical Reverse Characteristics

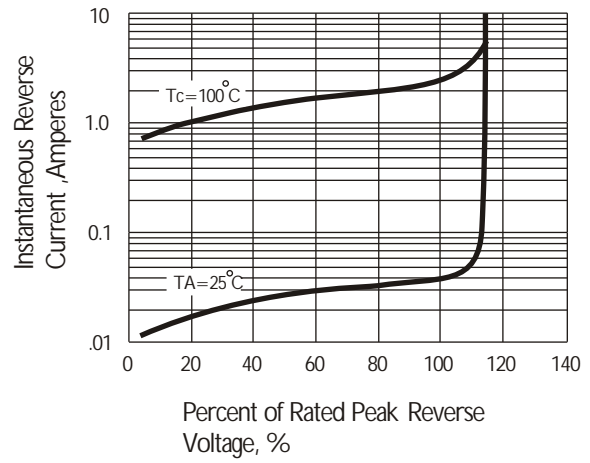
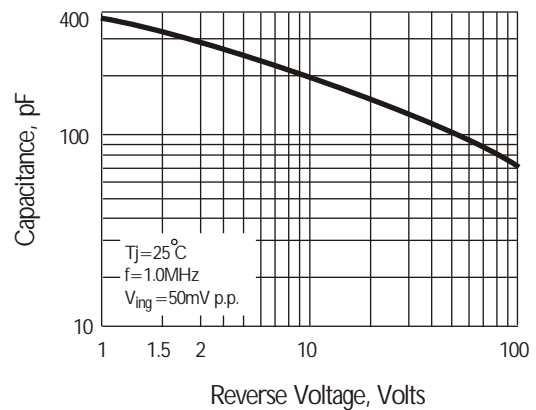

Fig. 5 Typical Junction Capacitance



X-ON Electronics

Largest Supplier of Electrical and Electronic Components

Click to view similar products for [Bridge Rectifiers](#) category:

Click to view products by [Shandong Baocheng](#) manufacturer:

Other Similar products are found below :

[MB252](#) [MB356G](#) [MB358G](#) [MP358-BP](#) [90MT160KPBF](#) [GBJ1504-BP](#) [GBU10B-BP](#) [GBU15J-BP](#) [GBU15K-BP](#) [GBU4A-BP](#) [GBU4D-BP](#)
[GSIB680-E3/45](#) [DB101-BP](#) [DBA150G](#) [DBA250G](#) [DBD10G-TM-E](#) [DBF10G](#) [DBG150G](#) [DBG250G](#) [DF01](#) [DF10SA-E345](#) [BU1508-E3/45](#)
[BU1510-E3/45](#) [KBPC50-10S](#) [RS405GL-BP](#) [26MT120](#) [G5SBA60-E3/51](#) [GBJ1502-BP](#) [GBU10J-BP](#) [GBU4J-BP](#) [GBU6M](#) [GBU8D-BP](#)
[GBU8J-BP](#) [GSIB1520-E3/45](#) [TB102M](#) [MB1510](#) [MB6M-G](#) [MB86](#) [TL401G](#) [MDA920A2](#) [TU602](#) [TU810](#) [MP501W-BP](#) [MP502-BP](#)
[BR1005-BP](#) [BR101-BP](#) [BR84DTP204](#) [BU1010A-E3/51](#) [BU1508-E3/51](#) [BU2006-E3/45](#)