

SPEC No.	LH17Z05A
ISSUE:	Dec.28,2017

To: OPTLASER TECHNOLOGIES CO.LTD

S P E C I F I C A T I O N S

Product Name Laser diode

G H 1 5 1 3 0 C 8 C

※These specifications contain 8 pages including the cover and appendix.
If you have any objections, please contact us before issuing purchasing order.

Accepted by:

By: _____

Name:

Title:

Date:

By: _____

Name:

Title:

Date:

Sharp Corporation

By: M. Matsumoto

Name: Mitsuhiro Matsumoto

Title: Dept. General Manager

Date: Development Department III

Laser Business Unit

Electronic Components And Devices BU

Date: Dec.28,2017

Reviewed by:

By: A. Ariyoshi

Name: Akira Ariyoshi

Title: Senior Manager

Date: Dec.28,2017

Prepared by:

By: M. Ishida

Name: Masaya Ishida

Title: Assistant Manager

Date: Dec.28,2017

1. These specification sheets include materials protected under copyright of Sharp Corporation ("Sharp").
Please handle with great cares and do not reproduce or cause anyone to reproduce them without Sharp's consent.
2. When using this Sharp product, please observe the absolute maximum ratings, other conditions and instructions for use described in the specification sheets, as well as the precautions mentioned below.
Sharp assumes no responsibility for any damages resulting from use of the product which does not comply with absolute maximum ratings, other conditions and instructions for use included in the specification sheets, and the precautions mentioned below.

(Precautions)

- (1) In making catalogue or instruction manual based on the specification sheets, please verify the validity of the catalogue or instruction manuals after assembling Sharp products in customer's products at the responsibility of customer.
- (2) This Sharp product is designed for use in the following application areas ;
 - Computers • OA equipment • Telecommunication equipment (Terminal) • Measuring equipment
 - Tooling machines • Audio visual equipment • Home appliancesIf the use of the Sharp product in the above application areas is for equipment listed in paragraphs (3) or (4), please be sure to observe the precautions given in those respective paragraphs.
- (3) Appropriate measures, such as fail-safe design and redundant design considering the safety design of the overall system and equipment, should be taken to ensure reliability and safety when Sharp product is used for equipment in responsibility of customer which demands high reliability and safety in function and precision, such as ;
 - Transportation control and safety equipment (aircraft, train, automobile etc.)
 - Traffic signals • Gas leakage sensor breakers • Rescue and security equipment
 - Other safety equipment
- (4) Sharp product is designed for consumer goods and controlled as consumer goods in production and quality.
Please do not use this product for equipment which require extremely high reliability and safety in function and precision, such as ;
 - Space equipment • Telecommunication equipment (for trunk lines)
 - Nuclear power control equipment • Medical equipment
- (5) Please contact and consult with a Sharp sales representative if there are any question regarding interpretation of the above four paragraphs.

3. Disclaimer

The warranty period for Sharp product is one (1) year (or six (6) months in case of generalized product) after shipment. During the period, if there are any products problem, Sharp will repair (if applicable), replace or refund. Except the above, both parties will discuss to cope with the problems.

The failed Sharp product after the above one (1) year (or six (6) month for generalized product) period will be coped with by Sharp, provided that both parties shall discuss and determine on sharing responsibility based on the analysis results thereof subject to the above scope of warranty.

The warranty described herein is only for Sharp product itself which are purchased by or delivered to customer. Damages arising from Sharp product malfunction or failure shall be excepted.

Sharp will not be responsible for the Sharp product due to the malfunction or failures thereof which are caused by:

- (1) storage keep trouble during the inventory in the marketing channel.
- (2) intentional act, negligence or wrong/poor handling.
- (3) equipment which Sharp products are connected to or mounted in.
- (4) disassembling, reforming or changing Sharp products.
- (5) installation problem.
- (6) act of God or other disaster (natural disaster, fire, flood, etc.)
- (7) external factors (abnormal voltage, abnormal electromagnetic wave, fire, etc.)
- (8) special environment (factory, coastal areas, hot spring area, etc.)
- (9) phenomenon which cannot be foreseen based on the practical technologies at the time of shipment.
- (10) the factors not included in the product specification sheet.

4. Please contact and consult with a Sharp sales representative for any questions about Sharp product.

【Outline of this product】

This product is equipped with an InAlGaN multiple quantum well green laser diode.

1. Scope
This specification covers the appearance and characteristics of green Laser Diode,
Model No. GH15130C8C
2. Outline Dimensions and Terminal Connections described in page 2/8
3. Ratings and Characteristics described in page 3/8
4. Reliability described in page 4/8
5. Quality level described in page 5/8
6. Supplements
 - 6-1. ODS materials described in page 5/8
 - 6-2. RoHS compliant product described in page 5/8
 - 6-3. Information relating to China RoHS. described in page 5/8
 - 6-4. Packing described in page 6/8
7. Operating and handling precautions described in page 7/8, 8/8

2. Outline dimensions and Terminal connections

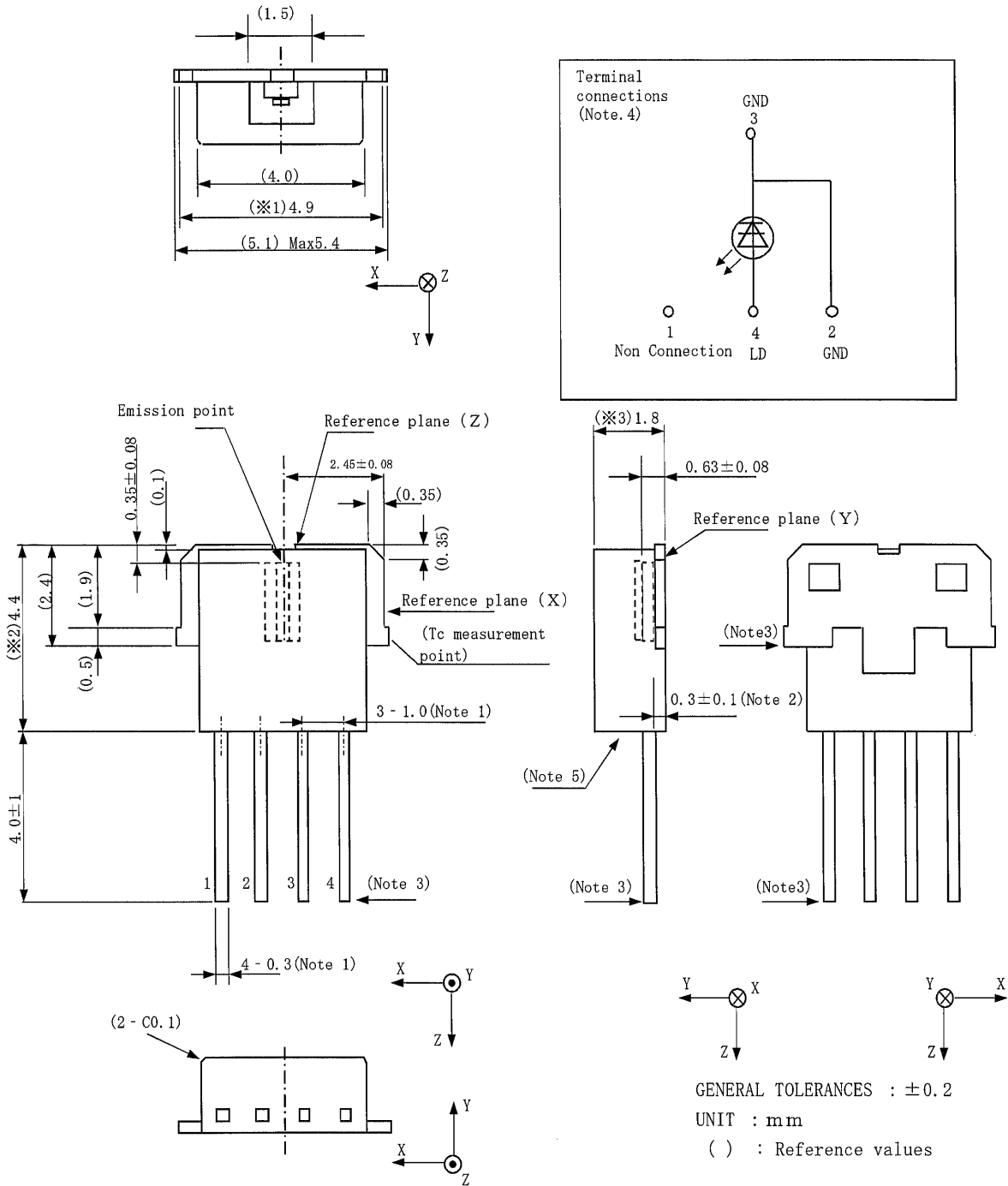

- Note 1) Dimension of the bottom of lead pins.
- Note 2) 0.3±0.1(mm) thickness lead frame board is used.
- Note 3) Cutting section of lead frame is no Ag plating.
Avoid soldering on this section.
- Note 4) Please don't connect the lead pin No.1 to the driving circuit.
- Note 5) Marking position.

Marking
 Position : Bottom side (Note 5)
 Method : Stamp
 Printed contents :
 g
 represents the production lot number

Component	Material	Finish
Laser Diode Chip	InAlGaN	-
Lead frame	Cu alloy	Ag plated
Resin (Body & cap)	LCP	-

3. Ratings and Characteristics

3-1 Absolute Maximum Ratings (Tc=25°C (Note 1))

Parameter	Symbol	Value	Unit
Optical power output	Po	35	mW
Reverse voltage	Vr1	2	V
Operating temperature	Topc(c)	-10 ~ +60	°C
Storage temperature	Tstg	-40 ~ +85	°C
Soldering temperature (Note 3)	Tsld	350	°C

(Note 1) Tc : Case temperature (Frame heat radiation part temperature)

(Note 2) CW Operation : Continuous Wave Operation

(Note 3) Soldering temperature means soldering iron tip temperature while soldering.
(The Power of soldering iron must be 50W or below.)

Soldering position is 2mm apart from bottom edge of the case. (Immersion time: 5s)

3-2 Electro-optical Characteristics of laser diode (Note 1) (Tc = 25°C)

Parameter	Symbol	Conditions	Min.	Typ.	Max.	Unit
Threshold current	Ith	-	-	30	50	mA
Operating current	Iop	Po=30mW	-	90	135	mA
Operating voltage	Vop		-	7.0	8.5	V
Wavelength	λp		510	515	525	nm
Half Intensity Angle(Parallel) (Note 2,3)	$\theta //$		5	7.5	10	°
Half Intensity Angle(Perpendicular) (Note2,3)	$\theta \perp$		19	22	25	°
Beam Tilt Angle (Parallel) (Note 3)	$\Delta \theta //$		-3	-	3	°
Beam Tilt Angle (Perpendicular) (Note 3)	$\Delta \theta \perp$		-3	-	3	°
Ripple (Note 4)	R12		-	-	30	%
Differential efficiency	ηd		$\frac{20mW}{I(30mW) - I(10mW)}$	0.35	0.50	-

(Note 1) Initial value, Continuous Wave Operation

(Note 2) Angle of 50% peak intensity (Full angle at half-maximum)

(Note 3) Parallel to the junction plane(X-Z plane)
Perpendicular to the junction plane(Y-Z plane)

(Note 4) $R12 = \Delta P / P$

ΔP : the maximum deviation of the far field pattern from its approximate curve

P: the peak of the approximate curve

- Approximate curve is calculated from the measuring data within the center area at 40% peak value.

- ΔP is calculated on the area within the center area at 25% peak value.

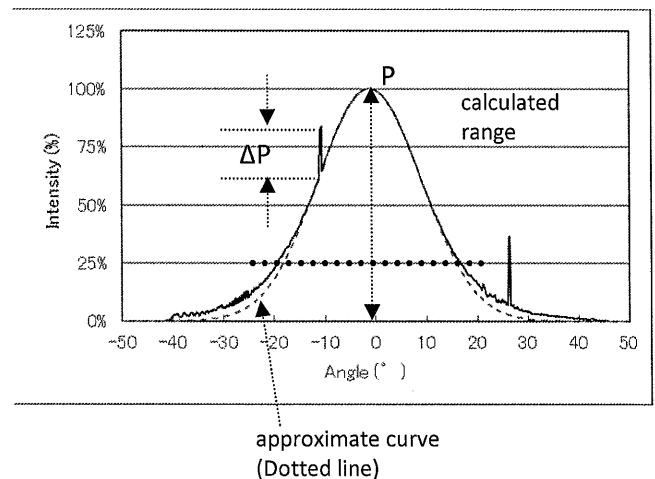

4. Reliability

4-1 The reliability of products satisfy all the items listed below. Confidence level : 90%

No.	Test	Test Conditions	Samples:n	Defective:C	LTPD (%)	Failure criteria No. [4-2]
1	Solderability	Soldering temperature: $240 \pm 5^\circ\text{C}$ Immersion time: $5 \pm 0.5\text{s}$ (Note 1) Use solder and flux: Made of SENZYU MATERIAL M705 and ESR-250	11	0	20	1
2	Resistance to soldering	Soldering temperature: $350 \pm 5^\circ\text{C}$ Immersion time: $5 \pm 1\text{s}$ (Note 1)	11	0	20	3, 4, 5
3	Terminal strength (Tensile test)	Load: 3N Duration: $5 \pm 1\text{s}$ Once for each terminal	11	0	20	2
4	Terminal strength (Bending test)	Load: 2.5N $0^\circ \sim +90^\circ \sim 0^\circ \sim -90^\circ \sim 0^\circ$ Once for each terminal	11	0	20	2
5	Mechanical shock	Acceleration: 1000m/s^2 Pulse width: 6ms Direction: $\pm X, \pm Y$ and $\pm Z$ Three times for each direction	11	0	20	3, 4, 5
6	Variable frequency vibration	Acceleration: 100m/s^2 or Amplitude: 1.5mm Frequency: 10~500~10Hz 15min reciprocation Direction: X, Y and Z 2 h for each direction	11	0	20	3, 4, 5
7	Temperature cycling	Lower temperature: -40°C Higher temperature: $+85^\circ\text{C}$ Duration: 30min each, 30 times	11	0	20	3, 4, 5
8	High temperature storage	Storage temperature: 85°C t=500 h	11	0	20	3, 4, 5
9	Low temperature storage	Storage temperature: -40°C t=500 h	11	0	20	3, 4, 5
10	High temperature Humid atmosphere storage	Storage temperature: 60°C (Note 2) humidity: 90%RH t=100h	11	0	20	3, 4, 5

Reference Standards : JIS

(Note 1) Soldering position is 2mm apart from bottom edge of the case.

(Soldering position is only lead section)

(Note 2) To be measured after 72 hours exposure to the room atmosphere.

(Note 3) These test results are sampling examples from a specific lot for reference purpose only, and do not constitute any warranty or assurance in connection with the devices.

4-2 Parameters to be measured and Failure criteria

No.	Parameters	Failure judgement criteria
1	Solderability	95% or more is covered with solder.
2	Terminal strength	It is defective if there are breaking and loosening.
3	Threshold current	$I_{th} > \text{initial value} \times 1.3, I_{th} < \text{initial value} \times 0.7$
4	Operating current	$I_{op} > \text{initial value} \times 1.3, I_{op} < \text{initial value} \times 0.7$
5	Operating voltage	$V_{op} > \text{initial value} \times 1.2, V_{op} < \text{initial value} \times 0.8$

4-3 Lifetime Test

The target mean time to failure (MTTF) of this product is more than 2,000 h. MTTF is confirmed by performing the operating test under the following conditions in time of development or change process related to the reliability of this product.

Samples tested should have a laser diode chip with the same structure of this model.

Conditions	Failure judgment criteria
Tc= 60°C , Po=30mW (init), 500 hours (Note 2)	Failure is defined as the time under the output power under the conditions in the left changes -50% of the initial (12 h) value (Note 1). As for the samples which do not fail within 500 hours, their life time is calculated by extrapolating operating power data of between 400 and 500 hours. MTTF is estimated by plotting each life time in Weibull function worksheet. (Note 1)

(Note 1) Defective samples caused by surge current is rejected.

(Note 2) ACC Operation

(Note 3) These test results are sampling examples from a specific lot for reference purpose only, and do not constitute any warranty or assurance in connection with the devices.

(Note 4) This package is a non-airtight package.

Lifetime may become short depending on the environment.

5. Quality level

5-1 Inspection standards ISO 2859 single sampling plan

5-2 Inspection level S-2 normal inspection

5-3 AQL

5-3-1 Definition of the lot the day shipping the product

5-3-2 Characteristics (Note 1)

AQL	Parameter	Failure judgement criteria
1.0	Ith, Iop, Vop, η d, λ p, θ //, θ \perp , Δ θ //, Δ θ \perp (Note 1)	Not conforming to the specifications

(Note 1) Inspection is performed after blowing LD.

5-3-3 Appearance

AQL	Failure judgment criteria
1.0	Marking is not sufficiently clear to read. Bent lead can not be restored.
2.5	The size regarding the reference plane of the package is not conforming the specification. (P. 2/8 ※1~※3)

(Note 2) Inspection is performed after blowing LD.

6. Supplements

6-1 ODS materials

This product shall not contain the following materials. Also, the following materials shall not be used in the production process for this product.

Materials for ODS : CFCs, Halon, Carbon tetrachloride, 1.1.1-Trichloroethane (Methylchloroform)

6-2 RoHS compliant product

This product complies with the RoHS Directive (2011/65/EU) and manufactured in accordance with Sharp's Green Device Guidelines.

6-3 Information relating to China RoHS.

Product Information Notification based on Chinese law, Management Methods for Controlling Pollution by Electronic Information Products.

Names and Contents of the Toxic and Hazardous Substances or Elements in the Product

Lead (Pb)	Mercury (Hg)	Cadmium (Cd)	Hexavalent Chromium (Cr(VI))	Polybrominated Biphenyls (PBB)	Polybrominated Diphenyl Ethers (PBDE)
○	○	○	○	○	○
<p>○ : indicates that the content of the toxic and hazardous substance in all the homogeneous materials of the part is below the concentration limit requirement as described in GB/T26572 standard.</p> <p>× : indicates that the content of the toxic and hazardous substance in at least one homogeneous material of the part exceeds the concentration limit requirement as described in GB/T26572 standard.</p>					

6-4. Packing

6-4-1. Packing method

- (1) Laser diodes are arranged in a tray.
- (2) One tray can accommodate 200 lasers maximum.
- (3) A vacant tray is stacked as a cover on the tray wherein the laser diodes are arranged. Stacked trays including a cover are bound with adhesive tape.
- (4) The above bound trays are stuffed into a Aluminum-bag. The bag is sealed by dissolving thermally.
- (5) The trays in the bag are put into a packing case. One packing case can accommodate 2,000 lasers maximum, which is the minimum unit of packing. A Label where in the model number, quantity and lot number are printed is stuck on both of the bag and the case(Refer to 6-4-4).

6-4-2. Materials for packing

No.	Component parts	Material
1	Laser tray	conductive polystyrene resin
2	Aluminum-bag	Aluminum
3	Packing case	cardboard
4	shock absorber	anti - static polyetyrene
5	Desiccating agent	SiO ₂

6-4-3. External appearance of packing

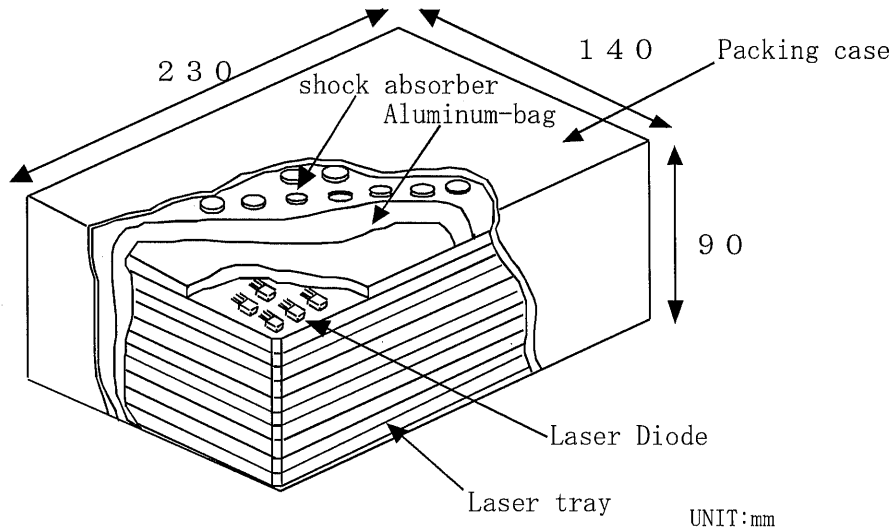

UNIT:mm



Mass of the regular packing (2,000pcs.): 1.40kg (reference value)

6-4-4. Label

(1)A label on the aluminum-bag

SHIPMENT TABLE	
PART No.	Model No.
QUANTITY.	Quantity
LOT No.	Quantity
	
Product Lot No.	
SHARP	
MADE IN ****(Note 1)	

(2)A label on the packing case

TYPE	Model No. (Note 2)
Q'TY	Quantity
LOT	Lot No. (the day shipping the product)
	
SHARP CORPORATION  (Note 3)	
MADE IN ****(Note 1)	
	

(Note 1) ****:Production country

(Note 2)A management number in the factory is written in (), if the product produced in a factory except Japan.

(Note 3)This identification mark shows the settlement product for RoHS designed by using a green material based on our green device guideline.

7. Operating and handling precautions

- (1) This product has its life. The product life which is described in "4. Reliability" should be taken into account when using it.
- (2) This product will be damaged by electrostatic discharge(ESD). Following precautions should be taken to avoid ESD damage.
 - ⇒ Workers, workbenches and other equipment should always be grounded. Workers should always wear an antistatic wrist strap and an antistatic smock on them.
 - ⇒ When handling this product, workers should always wear antistatic gloves or finger covers.
 - ⇒ A stable DC power supply which is free from electrical transients should always be used when operating this product. A slow starter circuit should always be inserted between the power supply and this product in order to protect it from DC power surges.
 - ⇒ Optical power output of this product should be set with a highly reliable and high quality variable resistance.
 - ⇒ This product should always be connected to the driving circuit by soldering directly or through highly reliable connectors.
 - ⇒ While this product is being operated, be sure to avoid touching the driving circuit or the terminals of this product with electrical probes from a synchro scope or a voltmeter.
 - ⇒ An antistatic package should be used when storing this product.
 - ⇒ This product should be processed in the rooms where relative humidity is kept at 50-70%RH.
- (3) This product is Non-hermetic package of resin.
 - In handling and the environment used, please use it especially noting the following respect.
 - ⇒ Please note that deterioration and the breakdown of the laser chip might be brought forward by humidity, the temperature, and the dewfall.
 - ⇒ Because this product is non-airtight product, handling to note the causticity gas especially is necessary. A causticity gas, an alkaline gas, and the acidic gas, etc. might bring deterioration and the breakdown of this product forward.
For example, when the rubber product and the heat radiation grease are arranged in the product neighborhood, it is necessary to note it.
 - ⇒ Process products in clean rooms, and avoid touching with bare hands. Because laser beam is highly coherent, dust traces or fingerprints on the surface of a laser chip are sufficient to interfere with the passing beam, causing ripples in the far field pattern.
 - ⇒ Avoid touching electrical devises, gold wire. Its infects optical - electrical characteristics.
 - ⇒ Avoid washing or cleaning this product. Its infects optical - electrical characteristics.
Using solvent causes damage, not only electrical devises but also resin package.
- (4) When soldering, following precautions should be taken. And please use under optimum conditions.
 - ⇒ When mounting an laser diode on PWB, do not apply physical stress to the lead pins.
 - ⇒ Avoid heating of the whole package by pre-heating or reflow. Heat only the lead section for short time duration.
- (5) When lead cutting and forming, do not apply heavy physical stress to the package.
- (6) A sufficient heat sink should be attached to this product when operating so that its case temperature is to be maintained at the same level as that of the surrounding.
- (7) The lead pins of this product consist of silver plated copper alloy. Do not operate with due point condition or freezing condition because of avoiding silver ionization.
- (8) Please finish soldering within 7 days, or keep the products in the N2-purged box after opening the package because of avoiding silver oxidization.
- (9) Even if the drive current supply has an automatic power control (APC), automatic current control (ACC), or both, be sure to monitor the optical power output with an optical power meter while setting it. Never estimate the optical power output only from the drive current because it is likely to be decreased by temperature rise of the surrounding.
- (10) Since laser beam from this product will be harmful to the human eyes, the following precautions should be taken.
 - ⇒ When this product is being operated, the emitting surface of a chip should not be viewed either directly or through a lens, microscope or optical fibers.
 - ⇒ When operating this product, wear safety glasses.

7. Operating and handling precautions

- (11) Guarantee covers the compliance to the quality standards mentioned in the Specifications; however it does not cover the compatibility with application in the end-use, including assembly and usage environment.
- (12) The products are not designed for the use under any of the following conditions. Please verify their performance and reliability well enough if you use under any of the following conditions:
- ① In a place with a lot of moisture, dew condensation, briny air, corrosive gas (Cl, H₂S, NH₃, SO₂, NO_x, etc.) and Si compound (siloxane and material that may generate Si-based gas)
 - ② Under the direct sunlight, outdoor exposure, and in a dusty place
 - ③ In water, oil, medical fluid, and organic solvents
- As stated above, device's lifetime may become short depending on the operating environment. When the environment like the above is assumed by an end user, please explain and confirm to end users.
- (13) The warranty described herein is only for Sharp product itself which are purchased by or delivered to customer. Damages arising from Sharp product malfunction or failure shall be excepted. The guarantee method is exchanging the laser device.

X-ON Electronics

Largest Supplier of Electrical and Electronic Components

Click to view similar products for [Standard LEDs - SMD category](#):

Click to view products by [Sharp manufacturer](#):

Other Similar products are found below :

[LTST-C19GD2WT](#) [LTST-N683GBEW](#) [597-3006-607F](#) [597-3403-607F](#) [LTW-K140SZR40](#) [LTW-M140ZVS](#) [598-8110-100F](#) [598-8170-100F](#)
[598-8610-202F](#) [7012X7](#) [AAAF5060QBFSEEZGS](#) [12-22SURSYGC/S530-A3/E2/TR8](#) [1383SURT/S530-A3/TR1\(R\)](#) [APT1608QGW](#)
[EASV1803BA0](#) [HT-F104TW-5860](#) [SML310BATT86](#) [SML-512VWT86A](#) [SML-LX0606SISUGC/A](#) [SML-LXL1307SRC-TR](#) [SML-](#)
[LXR851SIUPGUBC](#) [LT1ED53A](#) [17-21/G6C-FM1N2B/3T](#) [FAT801-S](#) [SSL-LXA227IC-TR31A](#) [AM27ZGC03](#) [APB3025SGNC](#)
[APHK1608VGCA](#) [APT2012QGW](#) [CLMVC-FKA-CA1E1L81BB7C3C3](#) [CLYBA-FKA-CFHHL9BBB7A363](#) [CMD11504UR](#) [LTW-](#)
[020ZDCG](#) [LTW-21TS5](#) [LTW-K140SZR30](#) [HSMY-C177](#) [HT-121UYG-4739](#) [UYGT801-S](#) [KVH1C100MF6R](#) [42-21SYGC/S530-E1/TR8](#)
[YGFR411-H](#) [597-2311-402F](#) [5973212407NF](#) [597-3302-607F](#) [597-5202-407F](#) [598-8330-117F](#) [SAW8WA2A-L35M40-CA](#) [SML013WBDW1](#)
[SML522BUWT86](#) [SML-LX0402IC-TR](#)