

Model Line-up

Diversified models with a different B.P.F. frequency are also available.

B.P.F. center frequency	Model No.	Unit
40	GP1UX31QS	kHz
36	GP1UX310QS	
38	GP1UX311QS	
36.7	GP1UX312QS	

Internal Block Diagram

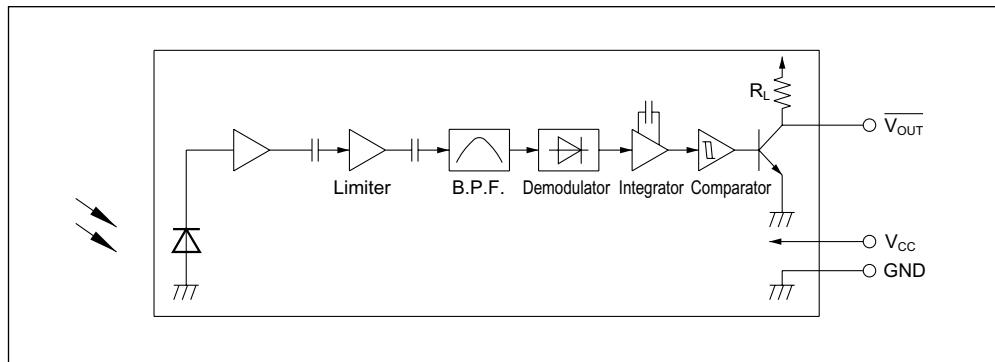

Electro-optical Characteristics

($T_a=25^\circ\text{C}$, $V_{CC}=3\text{V}$)

Parameter	Symbol	Conditions	MIN.	TYP.	MAX.	Unit
Dissipation current	I_{CC}	No input light	-	0.27	0.4	mA
High level output voltage	V_{OH}	^{*3}	$V_{CC}-0.5$	-	-	V
Low level output voltage	V_{OL}	^{*3} $I_{OL}=1.6\text{mA}$	-	-	0.45	V
High level pulse width	T_1	^{*3}	600	-	1200	μs
Low level pulse width	T_2	^{*3}	400	-	1000	μs
B.P.F. center frequency	f_0	-	-	^{*4}	-	kHz
Output pull-up resistance	R_L	-	70	100	130	$\text{k}\Omega$

^{*3} The burst wave as shown in the following figure shall be transmitted by the transmitter shown in Fig. 1
 The carrier frequency of the transmitter, however, shall be same as ^{*4}, and measurement shall be from just after starting the transmission until 50 pulse
^{*4} The B.P.F. center frequency f_0 varies with model, as shown in ■Model Line-up

Burst wave

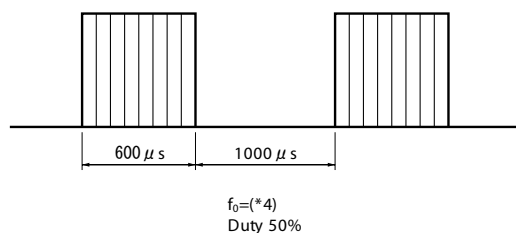

Output signal

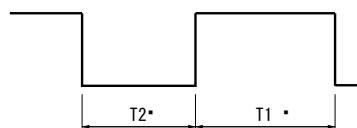

■ Performance

Using the transmitter shown in Fig. 1, the output signal of the light detecting unit is good enough to meet the following items in the standard optical system in Fig. 2.

1. Linear reception distance characteristics

When $L=0.2$ to 8.0m , ${}^5E_v < 10\text{ lx}$ and $\phi=0^\circ$ in Fig.2, the output signal shall meet the electrical characteristics in the attached list.

2. Sensitivity angle reception distance characteristics

When $L=0.2$ to 6.0m , ${}^5E_v < 10\text{ lx}$ and $\phi=30^\circ$ in Fig.2, the output signal shall meet the electrical characteristics in the attached list.

3. Anti outer peripheral light reception distance characteristics

When $L=0.2$ to 4.0m , ${}^6E_v \leq 300\text{ lx}$ and $\phi=0^\circ$ in Fig.2, the output signal shall meet the electrical characteristics in the attached list.

*5 It refers to detector face illuminance

*6 Outer peripheral light source: CIE standard light source A shall be used and placed at 45° from perpendicular axis at the detector face center

Fig.1 Transmitter

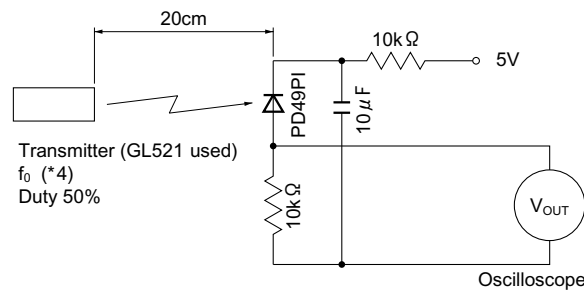

In the above figure, the transmitter should be set so that the output V_{OUT} (P-P) can be 40mV. However, the PD49PI to be used here should be of the short-circuit current $I_{SC}=2.6\mu\text{ A}$ at $E_v = 100\text{ lx}$. (E_v is an illuminance by CIE standard light source A (tungsten lamp).)

Fig.2 Standard Optical System

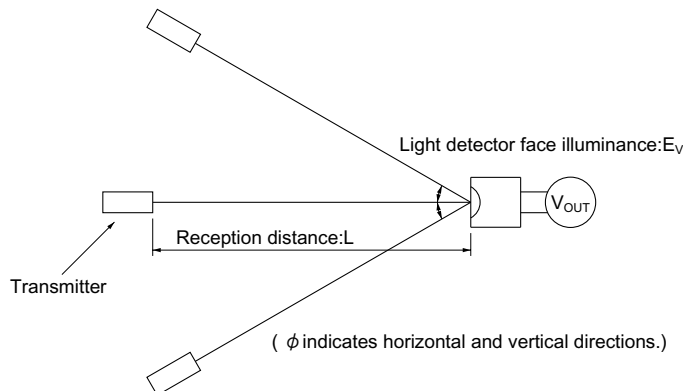

■ Precautions for Operation

1. When this infrared remote control detecting unit shall be adopted for wireless remote control, please use the following signal format . (NEC code,RC-6code etc.)

- Total duty ratio D_t (Emitting time $\sum_{N=1}^n t_{ON}$ / Transmitting time for 1 block T) : 40% or less.

- ON signal time and OFF signal time

Supply Voltage	V_{CC}	2.7 to 3.0V	3.0 to 5.5V
ON signal time per 1bit	t_{ON}	200 μ s or more	
OFF signal time per 1bit	t_{OFF}	400 μ s or more	300 μ s or more

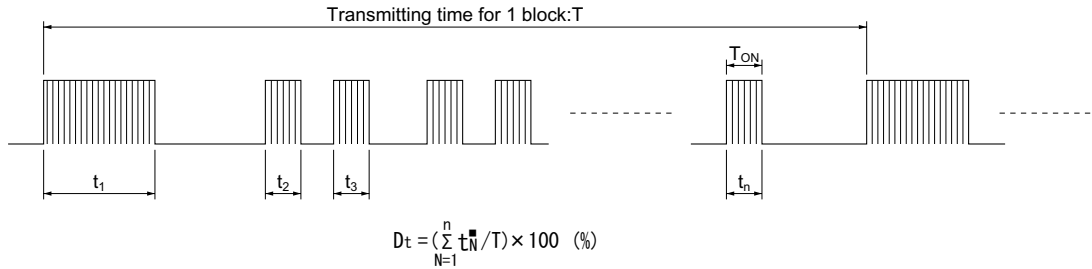

In case the signal format of total duty and/or ON/OFF signal time doesn't meet the conditions noted above, there is a case that reception distance much reduces or output dose not appear.

2. Use the light emitting unit (remote control transmitter), in consideration of performance, characteristics, operating conditions of light emitting device and the characteristics of the light detecting unit.

3. Pay attention to a malfunction of the light detecting unit when the surface is stained with dust and refuse.

Care must be taken not to touch the light detector surface.

If it should be dirty, wipe off such dust and refuse with soft cloth so as to prevent scratch. In case some solvents are required, use methyl alcohol, ethyl alcohol or isopropyl alcohol only.

Also, protect the light detecting unit against flux and others, since their deposition on the unit inside causes reduction of the function, fading of markings such as the part number.

4. Unnecessary force should not be applied to terminal.

5. Do not push the light detector surface (photodiode) from outside.

6. To avoid the electrostatic breakdown of IC, handle the unit under the condition of grounding with human body, soldering iron, etc.

7. Since conductive thermo plasticity is used in 2nd mold regin, please be careful not to come in contact with PCB land pattern.

8. External Circuit Examples (Mount the outer parts as near the unit as possible).

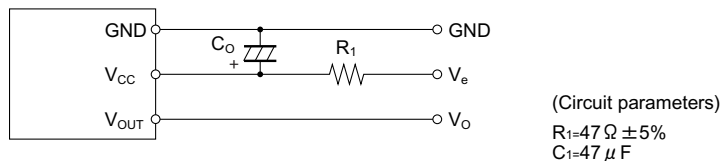

In setting R_1 and C_1 , use suitable values after considering under the real condition

The circuit constant is a example. It is difference from mounting equipment. Please select it by your mounting equipment.

This device has a transistor as protection element between V_{CC} and GND to improve anti-static electricity proof.

Please be carefully not to apply exceeding the absolute maximum ratings of applying voltage and continuous high voltage spike noise because there is cases that transistor will be short by secondary breakdown generally. In order to do difficultly, Please add CR filter(47 Ω (1/10W), 10 μ F or more)such as external circuit example above near V_{CC} .

9. There is a possibility that noise on output may be caused by environmental condition (Disturbing light noise, Electromagnetic noise, Power supply line noise, etc.) even if there is no input transmission signal.
10. Please shall confirm operation on your actual machine. Because the output pulse width of this product is fluctuated by environmental conditions such as signal format, temperature, distance from transmitter, and so on.
11. In case that this product is kept in high humidity condition, it may be hard to solder, please be careful enough about storage method.
Depend on the flux you select, there are different solderabilities, so please select a suitable flux and use it.
12. This product doesn't correspond to soldering by reflow.
13. Please make sure in case of hand soldering that use the solder iron with less than 45W power and solder iron point(edge) temperature is less than 320°C within 3 seconds, and also don't add any force to lead frame directly. And please make sure never to touch 2nd mold resin by a soldering.
14. When using this device, please be careful not to cause dew drop.
Be aware that the dew drop rusts lead pins portion and others, may affect the electric characteristics.
15. The lead frame may be deformed since the device is packed in vinyl bag.

X-ON Electronics

Largest Supplier of Electrical and Electronic Components

Click to view similar products for [Infrared Receivers](#) category:

Click to view products by [Sharp](#) manufacturer:

Other Similar products are found below :

[TSOP38436](#) [TSOP6136TR](#) [TSOP2456](#) [TSOP31456](#) [TSOP34356](#) [TSOP34456](#) [TSOP38336](#) [TSOP6130TT](#) [TSOP6940TT](#) [TSOP34438SS1V](#)
[GP1UX511QS](#) [TSOP34336SS1F](#) [TSSP57038ETT1](#) [TSOP57438ETT1](#) [TSOP37438HTT1](#) [TSOP6140TR](#) [TSOP53356](#) [TSOP53238](#)
[TSOP33238](#) [TSOP33256](#) [TSOP53256](#) [TSOP33138](#) [TSOP6133TT](#) [HL-PST-1608PT1F](#) [PT2424-6B](#) [TSOP37540QHTT1](#)
[E6C0805PRAC1UDA](#) [TSOP31136](#) [TSOP31140](#) [TSOP75238WTT](#) [RPM5537-H14E2A](#) [RPM6937-V4](#) [RPM7136-H4R](#) [RPM7238-H5R](#)
[TSOP4156](#) [TSOP6156TR](#) [TSOP75336WTT](#) [TSOP75338TR](#) [TSSP77038TT](#) [PD70-01C/TR7](#) [TSOP38138](#) [TSSP57P38TT1](#) [GP1UE292QKVF](#)
[GP1UM281XKVF](#) [GP1UM287RKVF](#) [GP1UM287XK](#) [TSOP59438](#) [TSOP58336](#) [TSOP38156](#) [PT19-21B/L41/TR8](#)