

GP2A200LCS0F Series

Detecting Distance : 2 to 22mm
 *OPIC Output,
 Reflective Photointerrupter with
 Connector

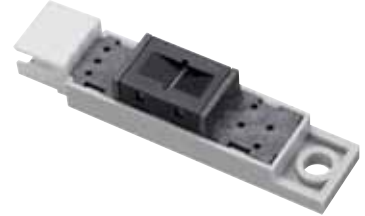

■ Description

GP2A200LCS0F Series are OPIC output, reflective photointerrupters with emitter and detector facing the same direction in a molding that provides non-contact sensing. This family of devices uses light modulation to reduce the affects of disturbing light, and the sensor is optimized to work in the selected focal distance. A 3-pin connector is included to allow remote-mount or off-board designs.

■ Features

1. Reflective with OPIC Light Modulated Output
2. Highlights :
 - Includes additional screw fixing holes
 - Position pin to prevent mis-alignment
 - Long focal distance
3. Key Parameters :
 - Detecting distance : 2 to 22mm (White paper)
5 to 15mm (Black paper)
 - Undetecting distance : over 90mm (White paper)
 - Connector : **GP2A200LCS0F** ; Tyco Electronics AMP K.K.
(PN : 292133-3)
GP2A200LCSCF ; Tyco Electronics AMP K.K.
(PN : 292133-3)
GP2A240LCS0F ; Tyco Electronics AMP K.K.
(PN : 292133-3)
GP2A210LCSJF ; Tyco Electronics AMP K.K.
(PN : 4-292133-3)
4. RoHS directive compliant

■ Agency approvals/Compliance

1. Compliant with RoHS directive

■ Applications

1. General purpose detection of paper presence or motion.
2. Example: PPC, FAX, Printer

* "OPIC"(Optical IC) is a trademark of the SHARP Corporation. An OPIC consists of a light-detecting element and a signal-processing

Notice The content of data sheet is subject to change without prior notice.
 In the absence of confirmation by device specification sheets, SHARP takes no responsibility for any defects that may occur in equipment using any SHARP devices shown in catalogs, data books, etc. Contact SHARP in order to obtain the latest device specification sheets before using any SHARP device.

Date code (2 digit)

1st digit		2nd digit	
Year of production		Month of production	
A.D.	Mark	Month	Mark
2000	0	1	1
2001	1	2	2
2002	2	3	3
2003	3	4	4
2004	4	5	5
2005	5	6	6
2006	6	7	7
2007	7	8	8
2008	8	9	9
2009	9	10	X
2010	0	11	Y
:	:	12	Z

repeats in a 10 year cycle

Country of origin

Japan

Fig.1 Test Condition for Peak Pulse Value I_{CCP}

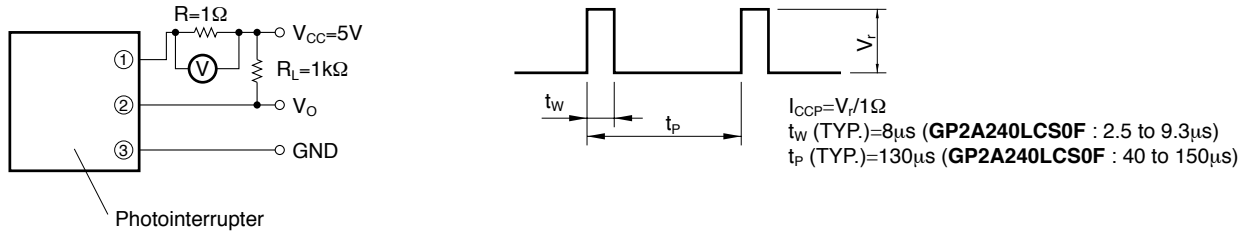

Fig.2 Test Condition for Detecting Distance Characteristics

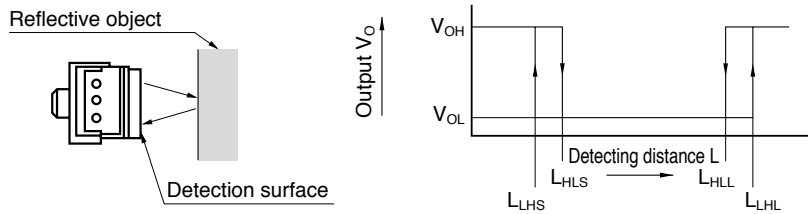

Fig.3 Test Circuit for Response Time

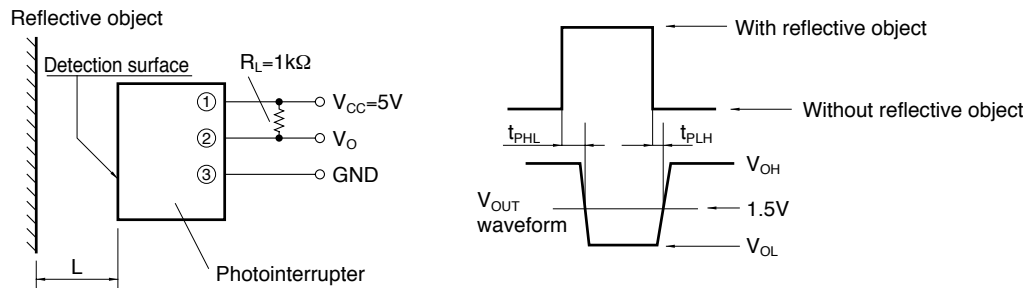

Fig.4 Test Condition for External Disturbing Light Illuminance

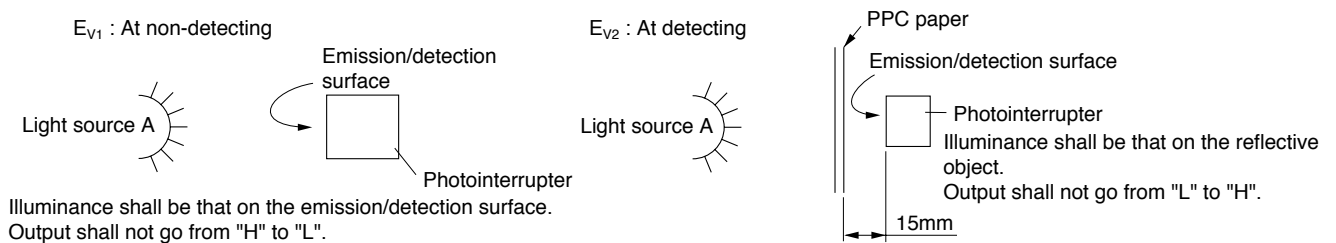

Fig.5 Output Current vs. Ambient Temperature

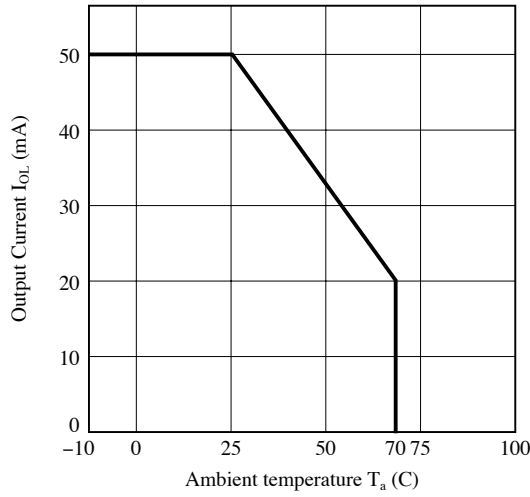

Fig.6 Low Level Output Voltage vs. Ambient Temperature

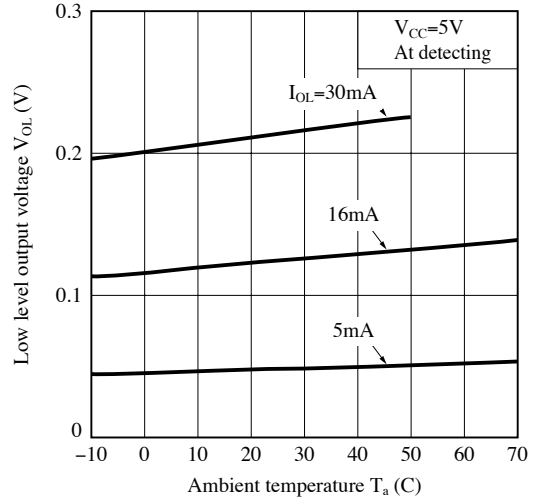

Fig.7 Low Level Output Voltage vs. Low Level Output Current

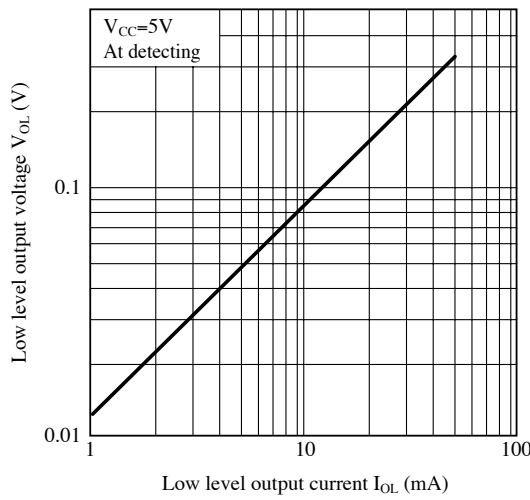
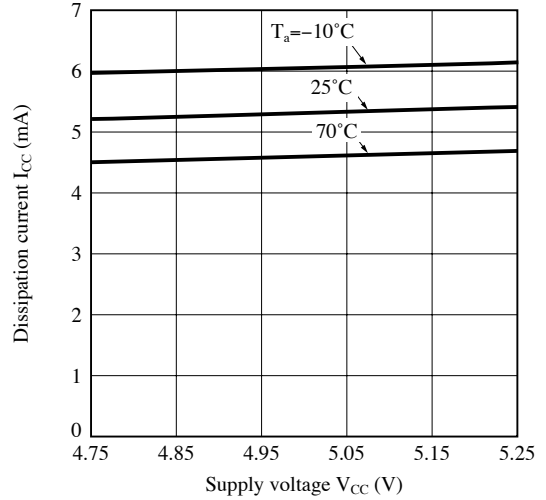

Fig.8 Dissipation Current(Smoothing Value) vs. Ambient Temperature



Remarks : Please be aware that all data in the graph are just for reference and not for guarantee.

■ **Design Considerations**

● **Design guide**

1) V_O terminal : Open collector output

This product operates the light emitter by pulse drive. Please supply the stable supply voltage in order to prevent error operation by pulse current.

Please use this device after connecting a capacitor between V_O and GND for prevention of line noise.

2) Prevention of detection error

Please be careful that you need to keep the direct inverter light away from the photo detecting surface since the device will not operate correctly in such case.

In addition, we recommend to make sure the operation test in the actual application.

3) Plugging in/out

The connector should be plugged in/out at normal temperature.

This product is not designed against irradiation and incorporates non-coherent IRED.

● **Parts**

This product is assembled using the below parts.

• **Photodetector (Q'ty : 1)** [Using a silicon photodiode as light detecting portion, and a bipolar IC as signal processing circuit]

Category	Maximum Sensitivity wavelength (nm)	Sensitivity wavelength (nm)	Response time (μs)
Phototransistor	900	700 to 1 200	400

• **Photo emitter (Q'ty : 1)**

Category	Material	Maximum light emitting wavelength (nm)	I/O Frequency (MHz)
Infrared emitting diode (non-coherent)	Gallium arsenide (GaAs)	950	0.3

• **Material**

	Case	Lens	Bottom cover
GP2A200LCS0F	Black polyphenylene Sulfide resin (UL94 V-0)	Polycarbonate resin (UL94 V-2)	Polycarbonate resin (Gray) (UL94 V-2)
GP2A200LCSCF			
GP2A210LCSJF*			Polycarbonate resin (Navy Blue) (UL94 V-2)
GP2A240LCS0F			

*The IR-90 filter (Fuji Photo Film Co., Ltd.) is inserted between case and detector side lens.

• **Others**

Laser generator is not used.

■ Manufacturing Guidelines**● Cleaning instructions**

Polycarbonate resin is used as the material of the lens surface. So this product shall not be cleaned by cleaning solvent absolutely. Dust and stain shall clean by air blow, or shall clean by soft cloth.

● Presence of ODC

This product shall not contain the following materials.

And they are not used in the production process for this product.

Regulation substances : CFCs, Halon, Carbon tetrachloride, 1.1.1-Trichloroethane (Methylchloroform)

Specific brominated flame retardants such as the PBBOs and PBBs are not used in this product at all.

This product shall not contain the following materials banned in the RoHS Directive (2002/95/EC).

•Lead, Mercury, Cadmium, Hexavalent chromium, Polybrominated biphenyls (PBB), Polybrominated diphenyl ethers (PBDE).

■ Package specification**● Case package**

Package materials

Anti-static plastic bag : Polyethylene

Moltopren : Urethane

Packing case : Corrugated fiberboard

Package method

100 pcs of products shall be packaged in a plastic bag, Ends shall be sealed by stapler. The bottom of the packing case is covered with moltopren, and 2 plastic bags shall be put into the packing case.

Moltopren should be located after all product are settled (1 packing contains 200 pcs).

Packing composition

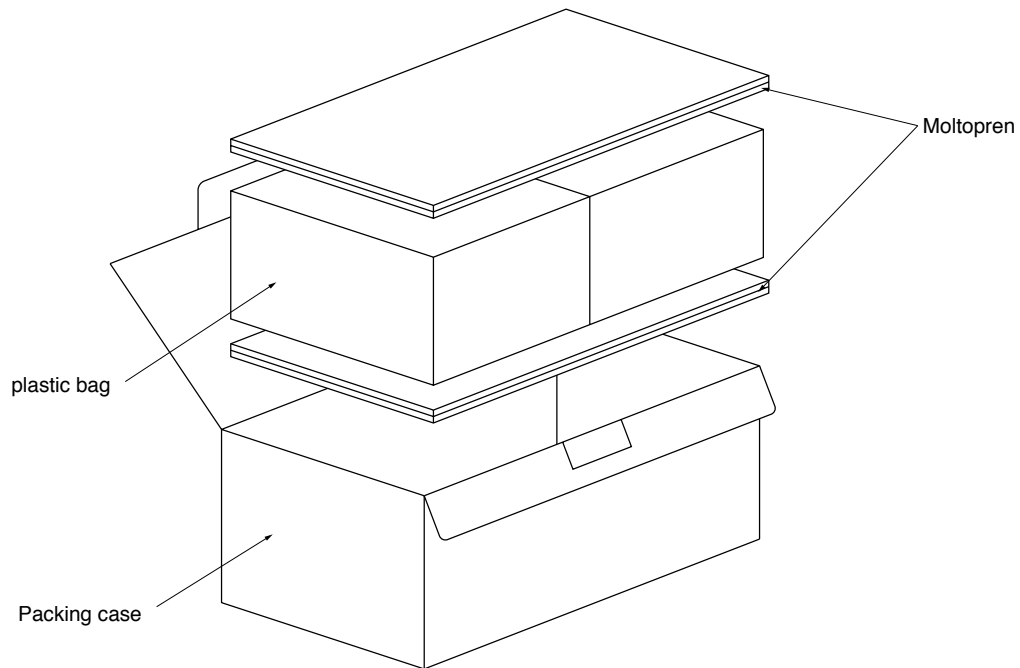

■ Important Notices

· The circuit application examples in this publication are provided to explain representative applications of SHARP devices and are not intended to guarantee any circuit design or license any intellectual property rights. SHARP takes no responsibility for any problems related to any intellectual property right of a third party resulting from the use of SHARP's devices.

· Contact SHARP in order to obtain the latest device specification sheets before using any SHARP device. SHARP reserves the right to make changes in the specifications, characteristics, data, materials, structure, and other contents described herein at any time without notice in order to improve design or reliability. Manufacturing locations are also subject to change without notice.

· Observe the following points when using any devices in this publication. SHARP takes no responsibility for damage caused by improper use of the devices which does not meet the conditions and absolute maximum ratings to be used specified in the relevant specification sheet nor meet the following conditions:

(i) The devices in this publication are designed for use in general electronic equipment designs such as:

- Personal computers
- Office automation equipment
- Telecommunication equipment [terminal]
- Test and measurement equipment
- Industrial control
- Audio visual equipment
- Consumer electronics

(ii) Measures such as fail-safe function and redundant design should be taken to ensure reliability and safety when SHARP devices are used for or in connection

with equipment that requires higher reliability such as:

- Transportation control and safety equipment (i.e., aircraft, trains, automobiles, etc.)
- Traffic signals
- Gas leakage sensor breakers
- Alarm equipment
- Various safety devices, etc.

(iii) SHARP devices shall not be used for or in connection with equipment that requires an extremely high level of reliability and safety such as:

- Space applications
- Telecommunication equipment [trunk lines]
- Nuclear power control equipment
- Medical and other life support equipment (e.g., scuba).

· If the SHARP devices listed in this publication fall within the scope of strategic products described in the Foreign Exchange and Foreign Trade Law of Japan, it is necessary to obtain approval to export such SHARP devices.

· This publication is the proprietary product of SHARP and is copyrighted, with all rights reserved. Under the copyright laws, no part of this publication may be reproduced or transmitted in any form or by any means, electronic or mechanical, for any purpose, in whole or in part, without the express written permission of SHARP. Express written permission is also required before any use of this publication may be made by a third party.

· Contact and consult with a SHARP representative if there are any questions about the contents of this publication.

X-ON Electronics

Largest Supplier of Electrical and Electronic Components

Click to view similar products for [Optical Switches](#), [Reflective](#), [Photo IC Output](#) category:

Click to view products by [Sharp](#) manufacturer:

Other Similar products are found below :

[GP2A230LRS0F](#) [GP2A230LRSAF](#) [GP2A240LCS0F](#) [ML6-H4K12GVA](#) [EE-SPY415](#) [EE-SG3M](#) [EE-SPY801](#) [EE-SPY802](#) [EE-SY1201](#) [EE-SY310](#) [EE-SY410](#) [EE-SY413](#) [GP2A200LCS0F](#) [GP2A200LCSCF](#) [GP2A25J0000F](#) [OPB716Z](#) [OPB720A-06Z](#) [OPB720A-12Z](#) [OPB720B-06Z](#) [OPB760N](#) [XB2-BW31B1C \(ZB2BWB11C+ZB2BW31C\)](#) [OPB9000](#) [AEDR-83001P2](#) [AEDR-8400-130](#) [C3012-TW-B-V](#) [C3012-TW-R-V](#) [ML6-H4KA2VA](#) [ECS-22RL1G-0020-L24G](#) [ECS-22RL1R-0020-L24R](#) [ECS-22RP1G-1000](#) [ECS-22RP1G-1020-L24G](#) [ECS-22RP1R-1000](#) [ECS-22RP1Y-1000](#) [ECS-22RP2G-1010](#) [ECS-22RP2G-1030-L24G](#) [ECS-22RP2R-1010](#) [ECS-22RP2R-1030-L24R](#) [ECS-22RP2Y-1010](#) [ECS-22RP3G-1000](#) [ECS-22RP3R-1000](#) [ECS-22RP3Y-1000](#) [C128973](#) [K6-6133D-L1-02](#) [K6-6136D-L1-04](#) [K6-6140D-03](#) [K6-6151S02](#) [K6-6270S-02](#) [K6-6271D-02](#) [K6-6272S-02](#) [K6-8859D-04](#)