

ISSUE : March 28, 2017

TO ; \_\_\_\_\_

## S P E C I F I C A T I O N S

Product Name      PHOTOCOUPLER

Model No.          PC817

**【Business dealing name : PC817X\*NIP1B】**

These specifications contain 12 pages including the cover and appendix.  
This specification sheets and attached sheets shall be both side copy.  
After confirmation of the contents, please be sure to send back     copy of the  
Specifications with approving signature on each.  
If you have any objections, please contact us before issuing purchasing order.

Accepted by:

By : \_\_\_\_\_  
Name :  
Title :  
Date :  
  
By : \_\_\_\_\_  
Name :  
Title :  
Date :

Sharp Corporation

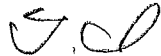
By :   
Name : T. Ichinose,  
Title : Division Manager,  
Development Division. V  
System Device Business Unit  
Electronic Components and Devices BU  
Date : Mar. 28, 2017

Reviewed by :

By :   
Name : T. Okuda  
Title : Senior Manager  
Date : Mar. 28, 2017

Prepared by :

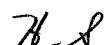
By :   
Name : H. Shoji  
Title : Supervisor  
Date : Mar. 28, 2017

1. These specification sheets include materials protected under copyright of Sharp Corporation ("Sharp"). Please handle with great cares and do not reproduce or cause anyone to reproduce them without Sharp's consent.
2. When using this Sharp product, please observe the absolute maximum ratings, other conditions and instructions for use described in the specification sheets, as well as the precautions mentioned below.  
Sharp assumes no responsibility for any damages resulting from use of the product which does not comply with absolute maximum ratings, other conditions and instructions for use included in the specification sheets, and the precautions mentioned below.

(Precautions)

- (1) In making catalogue or instruction manual based on the specification sheets, please verify the validity of the catalogue or instruction manuals after assembling Sharp products in customer's products at the responsibility of customer.
- (2) This Sharp product is designed for use in the following application areas ;
  - Computers • OA equipment • Telecommunication equipment (Terminal) • Measuring equipment
  - Tooling machines • Audio visual equipment • Home appliancesIf the use of the Sharp product in the above application areas is for equipment listed in paragraphs (3) or (4), please be sure to observe the precautions given in those respective paragraphs.
- (3) Appropriate measures, such as fail-safe design and redundant design considering the safety design of the overall system and equipment, should be taken to ensure reliability and safety when Sharp product is used for equipment in responsibility of customer which demands high reliability and safety in function and precision, such as ;
  - Transportation control and safety equipment (aircraft, train, automobile etc.)
  - Traffic signals • Gas leakage sensor breakers • Rescue and security equipment
  - Other safety equipment
- (4) Sharp product is designed for consumer goods and controlled as consumer goods in production and quality. Please do not use this product for equipment which require extremely high reliability and safety in function and precision, such as ;
  - Space equipment • Telecommunication equipment (for trunk lines)
  - Nuclear power control equipment • Medical equipment
- (5) Please contact and consult with a Sharp sales representative if there are any question regarding interpretation of the above four paragraphs.

3. Disclaimer

The warranty period for Sharp product is one (1) year after shipment.  
During the period, if there are any products problem, Sharp will repair (if applicable), replace or refund.  
Except the above, both parties will discuss to cope with the problems.

The failed Sharp product after the above one (1) year period will be coped with by Sharp, provided that both parties shall discuss and determine on sharing responsibility based on the analysis results thereof subject to the above scope of warranty.

The warranty described herein is only for Sharp product itself which are purchased by or delivered to customer.  
Damages arising from Sharp product malfunction or failure shall be excepted.

Sharp will not be responsible for the Sharp product due to the malfunction or failures thereof which are caused by:

- (1) storage keep trouble during the inventory in the marketing channel.
- (2) intentional act, negligence or wrong/poor handling.
- (3) equipment which Sharp products are connected to or mounted in.
- (4) disassembling, reforming or changing Sharp products.
- (5) installation problem.
- (6) act of God or other disaster (natural disaster, fire, flood, etc.)
- (7) external factors (abnormal voltage, abnormal electromagnetic wave, fire, etc.)
- (8) special environment (factory, coastal areas, hot spring area, etc.)
- (9) phenomenon which cannot be foreseen based on the practical technologies at the time of shipment.
- (10) the factors not included in the product specification sheet.

4. Please contact and consult with a Sharp sales representative for any questions about Sharp product.

1. Application

This specification applies to the outline and characteristics of photocoupler Model No. PC817series(Lead-Free Type).

2. Outline Refer to the attached sheet, page 4.

3. Ratings and characteristics Refer to the attached sheet, page 5, 6.

4. Reliability Refer to the attached sheet, page 7.

5. Outgoing inspection Refer to the attached sheet, page 8.

6. Supplement

6.1 Isolation voltage shall be measured in the following method.

- (1) Short between anode and cathode on the primary side and between collector and emitter on the secondary side.
- (2) The dielectric withstanding tester with zero-cross circuit shall be used.
- (3) The wave form of applied voltage shall be a sine wave.  
(It is recommended that the isolation voltage be measured in insulation oil.)

6.2 Package specifications Refer to the attached sheet, page 9, 10.

6.3 Business dealing name ("○" mark indicates business dealing name of ordered product)

Ordered product	Business dealing name	Rank mark	Ic (mA)	Test conditions
	PC817XNNIP1B	with or 「_」	2.5 to 30.0	I <sub>F</sub> =5mA V <sub>CE</sub> =5V T <sub>a</sub> =25°C
	PC817X1NIP1B	A	4.0 to 8.0	
	PC817X2NIP1B	B	6.5 to 13.0	
	PC817X3NIP1B	C	10.0 to 20.0	
	PC817X4NIP1B	D	15.0 to 30.0	
	PC817X5NIP1B	A or B	4.0 to 13.0	
	PC817X6NIP1B	B or C	6.5 to 20.0	
	PC817X7NIP1B	C or D	10.0 to 30.0	
	PC817X8NIP1B	A, B or C	4.0 to 20.0	
	PC817X9NIP1B	B, C or D	6.5 to 30.0	
	PC817X0NIP1B	A, B, C or D	4.0 to 30.0	

6.4 This Model is approved by UL.

Approved Model No. : PC817

UL file No. : E64380

6.5 This Model is approved by CSA.

Approved Model No. : PC817

CSA approved mark "  " shall be indicated on minimum unit package.

6.6 This product is not designed against irradiation.

This product is assembled with electrical input and output.

This product incorporates non-coherent light emitting diode.

6.7 ODS materials

This product shall not contain the following materials.

Also, the following materials shall not be used in the production process for this product.

Materials for ODS : CFCs, Halon, Carbon tetrachloride, 1.1.1-Trichloroethane (Methyl chloroform)

6.8 Specified brominated flame retardants

Specified brominated flame retardants (PBB and PBDE) are not used in this device at all

6.9 Compliance with each regulation

- (1) The RoHS directive(2011/65/EU)

This product complies with the RoHS directive(2011/65/EU) .

Object substances: mercury, lead, cadmium, hexavalent chromium, polybrominated biphenyls (PBB) and polybrominated diphenyl ethers (PBDE)

- (2) Content of six substances specified in Management Methods for Control of Pollution Caused by Electronic Information Products Regulation (Chinese : 电子信息产品污染控制管理办法).

Marking Styles for the Names and Contents of the Hazardous Substances

Category	Hazardous Substances					
	Lead (Pb)	Mercury (Hg)	Cadmium (Cd)	Hexavalent chromium (Cr <sup>6+</sup> )	Polybrominated biphenyls (PBB)	Polybrominated diphenyl ethers (PBDE)
Photocoupler	○	○	○	○	○	○

This table is prepared in accordance with the provisions of SJ/T 11364.

○ : Indicates that said hazardous substance contained in all of the homogeneous materials for this part is below the limit requirement of GB/T 26572

7. Notes

Precautions for photocouplers : Attachment-1

# PC817X\*NIP1B REFERENCE

## 2. Outline

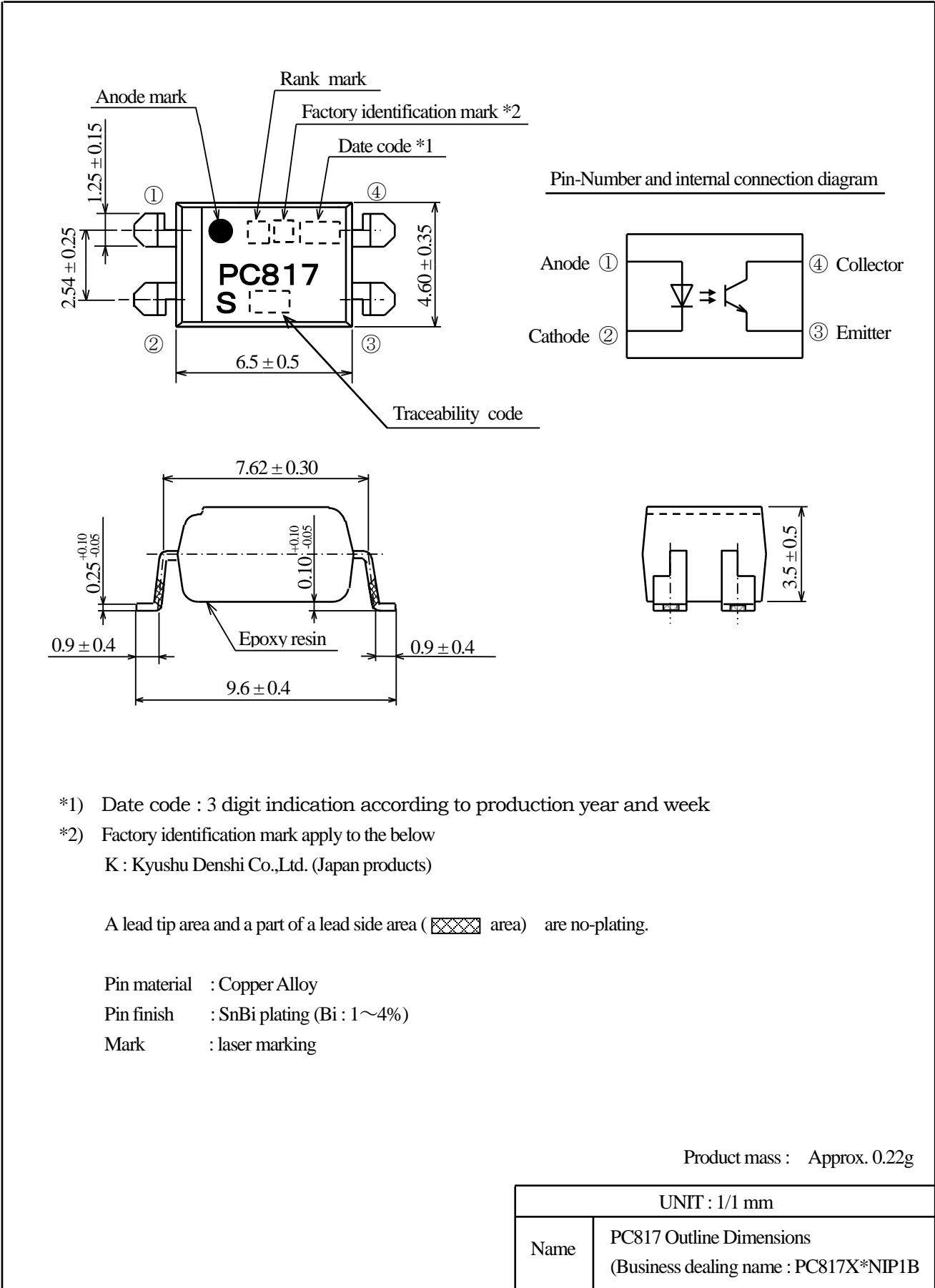

### 3. Ratings and characteristics

#### 3.1 Absolute maximum ratings

Ta=25°C

Parameter		Symbol	Rating	Unit
Input	*1 Forward current	I <sub>F</sub>	50	mA
	*2 Peak forward current	I <sub>FM</sub>	1	A
	Reverse voltage	V <sub>R</sub>	6	V
	*1 Power dissipation	P	70	mW
Output	Collector-emitter voltage	V <sub>CEO</sub>	80	V
	Emitter-collector voltage	V <sub>ECO</sub>	6	V
	Collector current	I <sub>c</sub>	50	mA
	*1 Collector power dissipation	P <sub>c</sub>	150	mW
*1 Total power dissipation	P <sub>tot</sub>	200	mW	
Operating temperature		T <sub>opr</sub>	-30 to +100	°C
Storage temperature		T <sub>stg</sub>	-55 to +125	°C
*3 Isolation voltage	V <sub>iso(rms)</sub>	5	kV	
*4 Soldering temperature	T <sub>sol</sub>	270	°C	

#### 3.2 Electro-optical characteristics

Ta=25°C

Parameter		Symbol	Condition	MIN.	TYP.	MAX.	Unit
Input	Forward voltage	V <sub>F</sub>	I <sub>F</sub> =20mA	-	1.2	1.4	V
	Peak forward voltage	V <sub>FM</sub>	I <sub>FM</sub> =0.5A	-	-	3.0	V
	Reverse current	I <sub>R</sub>	V <sub>R</sub> =4V	-	-	10	μA
	Terminal capacitance	C <sub>t</sub>	V=0, f=1kHz	-	30	250	pF
Output	Dark current	I <sub>CEO</sub>	V <sub>CE</sub> =50V, I <sub>F</sub> =0	-	-	100	nA
	Collector-emitter breakdown voltage	BV <sub>CEO</sub>	I <sub>c</sub> =0.1mA, I <sub>F</sub> =0	80	-	-	V
	Emitter-collector breakdown voltage	BV <sub>ECO</sub>	I <sub>E</sub> =10 μA, I <sub>F</sub> =0	6	-	-	V
Transfer characteristics	Collector current	I <sub>c</sub>	I <sub>F</sub> =5mA, V <sub>CE</sub> =5V	2.5	-	30	mA
	Collector-emitter saturation voltage	V <sub>CE(sat)</sub>	I <sub>F</sub> =20mA, I <sub>c</sub> =1mA	-	0.1	0.2	V
	Isolation resistance	R <sub>ISO</sub>	DC500V, 40 to 60%RH	5 × 10 <sup>10</sup>	10 <sup>11</sup>	-	Ω
	Floating capacitance	C <sub>f</sub>	V=0, f=1MHz	-	0.6	1.0	pF
	Cut-off frequency	f <sub>c</sub>	V <sub>CE</sub> =5V, I <sub>c</sub> =2mA R <sub>L</sub> =100Ω, -3dB	-	80	-	kHz
	Rise time	t <sub>r</sub>	V <sub>CE</sub> =2V, I <sub>c</sub> =2mA	-	4	18	μs
	Fall time	t <sub>f</sub>	R <sub>L</sub> =100Ω	-	3	18	μs

\*1 The derating factors of absolute maximum ratings due to ambient temperature are shown in Fig. 1 to 4.

\*2 Pulse width ≤ 100 μs, Duty ratio : 0.001 (Refer to Fig. 5)

\*3 AC for 1 min, 40 to 60%RH

\*4 For 10s

(Fig. 1) Forward current vs. Ambient temperature

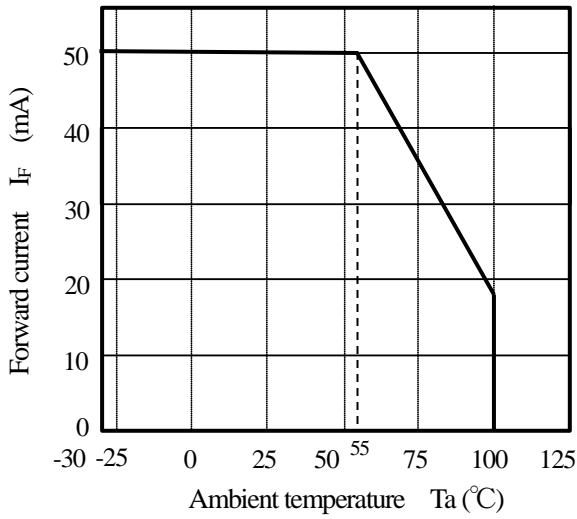

(Fig. 2) Diode power dissipation vs. Ambient temperature

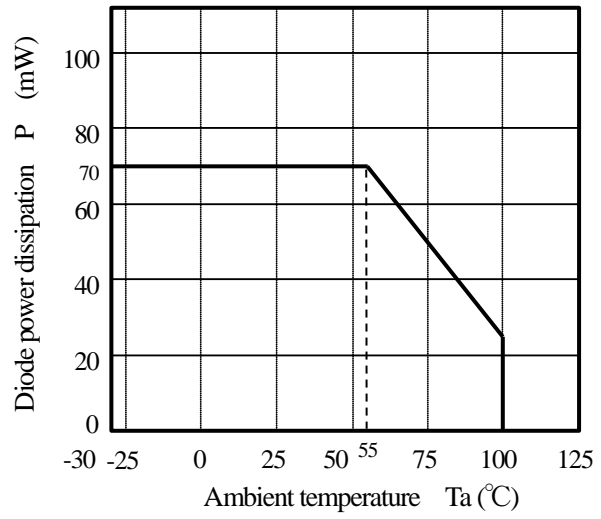

(Fig. 3) Collector power dissipation vs. Ambient temperature

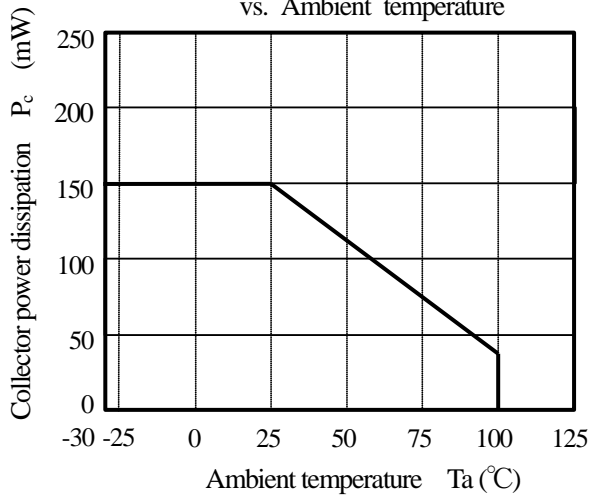

(Fig. 4) Total power dissipation vs. Ambient temperature

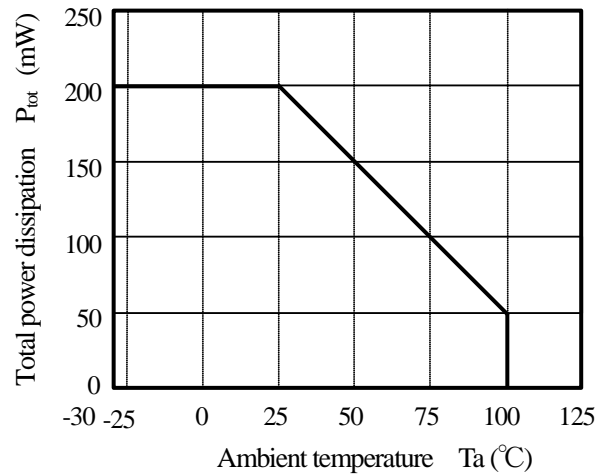

(Fig.5) Peak forward current vs. Duty ratio  
 Pulse width  $\leq 100\mu s$   
 $T_a = 25^\circ C$

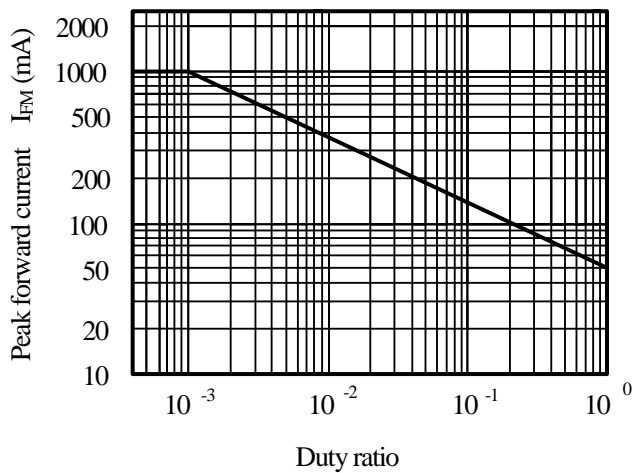

4. Reliability

The reliability of products shall satisfy items listed below.

Confidence level : 90%

LTPD : 10 or 20

Test Items	Condition *1	Failure Judgment Criteria	Samples (n) Defective (C)
Solderability	245±3°C, 5s	*2	n=11, C=0
Soldering heat	(Flow soldering) 270°C, 10 s	$V_F > U \times 1.2$ $I_R > U \times 2$ $I_{CEO} > U \times 2$ $I_C < L \times 0.7$ $V_{CE(sat)} > U \times 1.2$  U: Upper specification limit L: Lower specification limit	n=11, C=0
	(Soldering by hand) 400°C, 3 s		n=11, C=0
Terminal strength (Tension)	Weight: 5N 5 s/each terminal		n=11, C=0
Terminal strength (Bending) *3	Weight: 2.5N 2 times/each terminal		n=11, C=0
Mechanical shock	15km/s <sup>2</sup> , 0.5ms 3 times/±X, ±Y, ±Z direction		n=11, C=0
Variable frequency vibration	100 to 2000 to 100Hz/4 min 200m/s <sup>2</sup> 4 times/X, Y, Z direction		n=11, C=0
Temperature cycling	1 cycle -55°C to +125°C (30 min) (30 min) 20 cycles test		n=22, C=0
High temp. and high Humidity storage	+85°C, 85%RH, 1000h		n=22, C=0
High temp. storage	+125°C, 1000h		n=22, C=0
Low temp. storage	-55°C, 1000h		n=22, C=0
Operation life	I <sub>F</sub> =50mA, P <sub>tot</sub> =200mW T <sub>a</sub> =25°C, 1000h	n=22, C=0	

\*1 Test method, conforms to EIAJ ED 4701.

\*2 The product whose not-soldered area is more than 5% for all of the dipped area and/or whose pinholes or voids are concentrated on one place shall be judged defect.

\*3 Terminal bending direction is shown below.

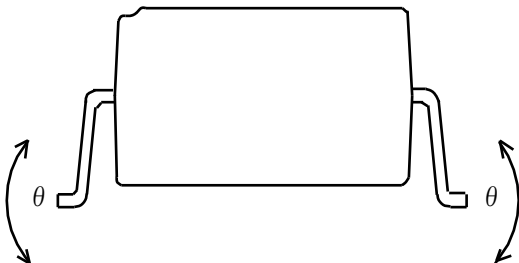

※ These test results are sampling examples from a specific lot for reference purpose only, and do not constitute any warranty or assurance in connection with the products



5. Outgoing inspection

5.1 Inspection items

(1) Electrical characteristics

$V_F$ ,  $I_R$ ,  $I_{CEO}$ ,  $V_{CE(sat)}$ ,  $I_c$ ,  $R_{ISO}$ ,  $V_{iso}$

(2) Appearance

5.2 Sampling method and Inspection level

LTPD sampling inspection

confidence level : 90%

Defect	Inspection item	LTPD (%)
Major defect	Electrical characteristics(faiure) Marking (Unreadable) Lead form (Deformation)	3
Minor defect	Appearance defect except the above mentioned.	50

6.2 Package specifications

6.2.1 Taping conditions

- (1) Tape structure and Dimensions ( Refer to below in this page. )

The carrier tape has the heat pressed structure of PS material carries tape and PET material cover tape.

- (2) Reel structure and Dimensions (Refer to the attached sheet, Page 10)

The taping reel shall be of plastic (PS material)

- (3) Direction of product insertion (Refer to the attached sheet, Page 10)

- (4) The cover tape and carrier tape in one reel shall be joint less.

- (5) To repair failure-taped devices, cutting a bottom of carrier tape or a cover tape with a cutter.

After replacing the cut portion shall be sealed with adhesive tape.

6.2.2 Adhesiveness of cover tape

The exfoliation force between carrier tape and cover tape shall be 0.2N to 0.7N

6.2.3 Rolling method and quantity

Wind the tape back on the reel so that the cover tape will be outside the tape.

Attach more than 18cm of blank tape to the trailer and the leader of the tape

And fix the leader with adhesive tape. One reel basically contain 2000pcs

6.2.4 Outer packing appearance (Refer to the attached sheet, Page 10)

6.2.5 The label with following information shall be pasted at appointed place of the outer packing case.

\*Model No. \*( Business dealing name ) \*Lot No. \*Quantity

\*Country of origin \*Company name \*Inspection date specified

6.2.6 Storage condition

Taped products shall be stored at the temperature 5 to 30°C and the humidity 70%RH or less away from direct sunlight.

6.2.7 Safety protection during shipping

There shall be no deformation of component or degradation of electrical characteristics due to shipping.

Carrier tape structure and Dimensions

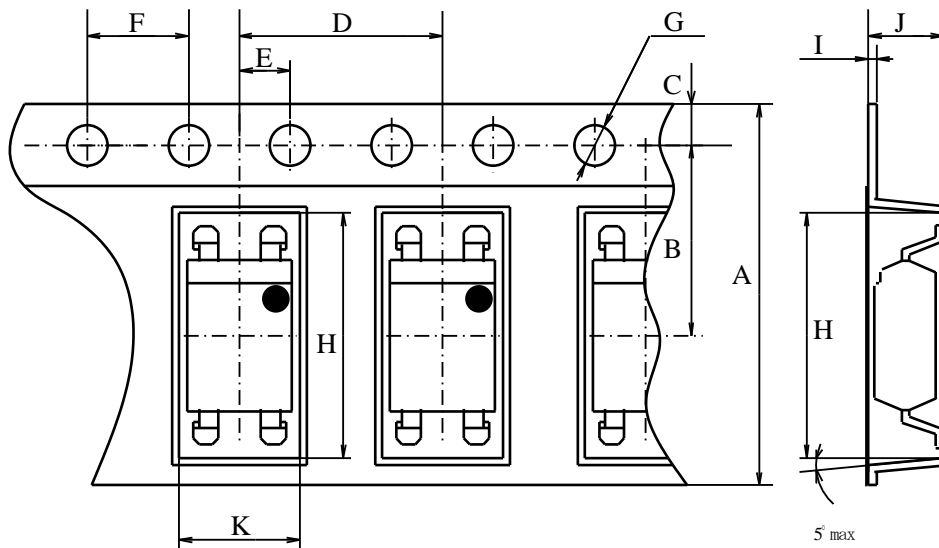

Dimensions list (Unit : mm)

A	B	C	D	E	F	G	H	I	J	K
16.0±0.3	7.5±0.1	1.75±0.1	8.0±0.1	2.0±0.1	4.0±0.1	φ 1.5 <sup>+0.1</sup> <sub>-0</sub>	10.3±0.1	0.40±0.05	4.0±0.1	5.3±0.1

# PCSI-X-NP1B REFERENCE

Reel structure and Dimensions

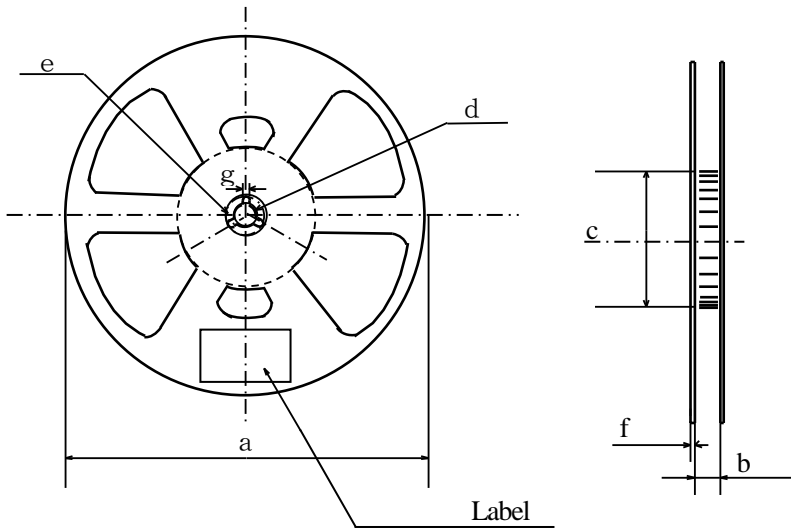

Dimensions list (Unit : mm)

a	b	c	d
(330)	17.5±1.5	φ 100.0±1.0	φ 13.0±0.5
e	f	g	
φ 21.0±1.0	2.0±0.5	2.0±0.5	

Direction of product insertion

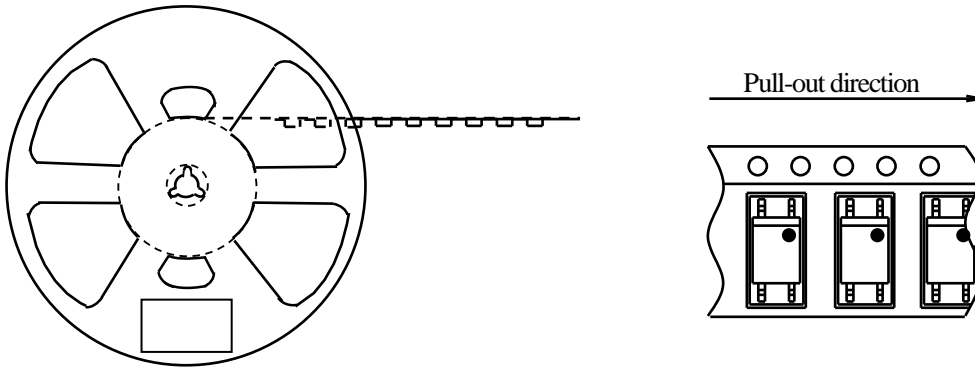

Outer packing appearance

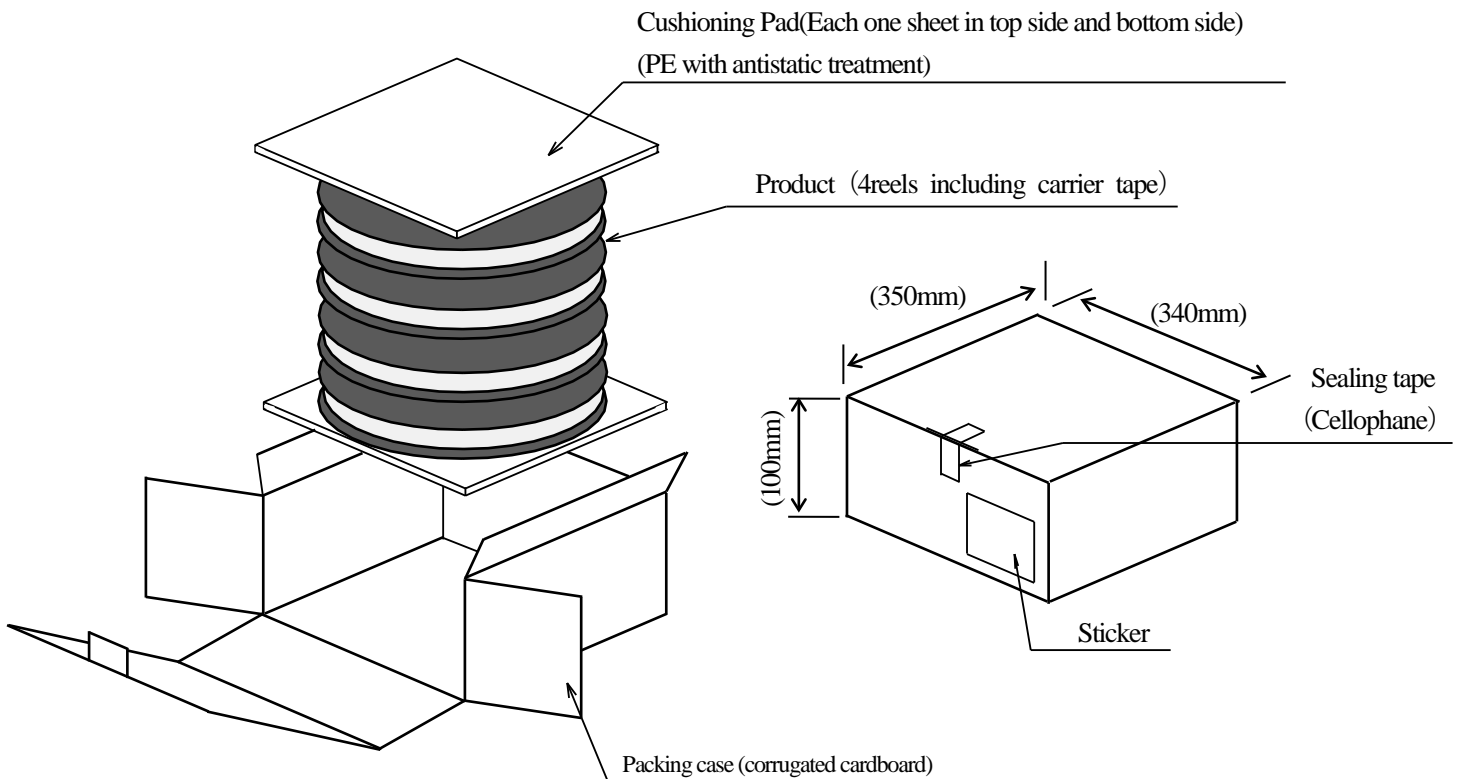

Regular packing mass : Approx. 3.4kg

( ) : Reference dimensions

## Precautions for Photocouplers

### 1 Cleaning

- (1) Solvent cleaning : Solvent temperature 45°C or less  
Immersion for 3 min or less
- (2) Ultrasonic cleaning : The effect to device by ultrasonic cleaning differs by cleaning bath size, ultrasonic power output, cleaning time, PCB size or device mounting condition etc. Please test it in actual using condition and confirm that any defect doesn't occur before starting the ultrasonic cleaning.
- (3) Applicable solvent : Ethyl alcohol, Methyl alcohol, Isopropyl alcohol  
When the other solvent is used, there are cases that the packaging resin is eroded.  
Please use the other solvent after thorough confirmation is performed in actual using condition.

### 2. Circuit design

- (1) The LED used in the Photocoupler generally decreases the light emission power by operation.  
In case of long operation time, please design the circuit in consideration of the degradation of the light emission power of the LED. (50%/5years)
- (2) There are cases that the deviation of the IC and the degradation of the relative light emission power of the LED increase when the setting value of  $I_F$  is less than 1.0mA. Please design the circuit in consideration of this point.

### 3. Precautions for Soldering

- (1) In the case of flow soldering (Whole device dipping .)  
It is recommended that flow soldering should be at 270°C or less for 10 s or less  
(Pre-heating : 100 to 150°C, 30 to 80s). (2 times or less)
- (2) If solder reflow :  
It is recommended to be done at the temperature and the time within the temperature profile as shown in the figure below. (2 times or less)

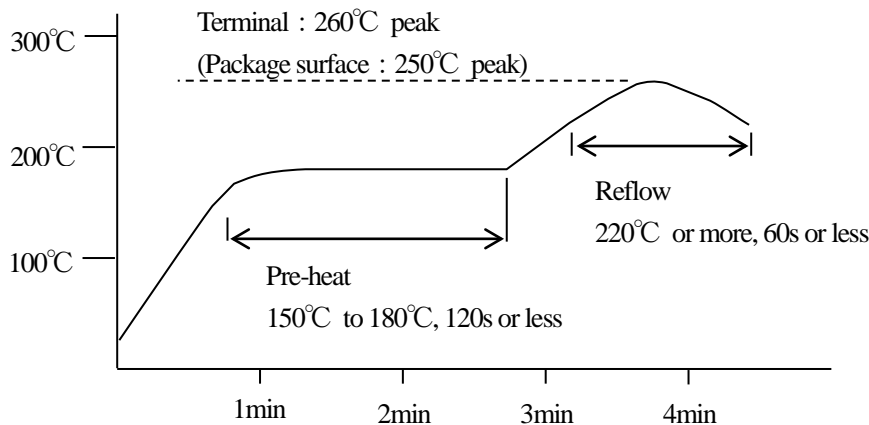

- (3) In the case of hand soldering  
What is done on the following condition is recommended.( 2 times or less)  
Soldering iron temperature : 400°C or less  
Time : 3s or less
- (4) The form of a lead tip part

There is production tolerance as shown in the following figure

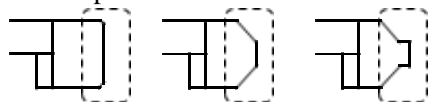

- (5) Other precautions

Depending on equipment and soldering conditions (temperature, Using solder etc.), the effect to the device and the PCB is different.

Please confirm that there is no problem on the actual use conditions in advance.

## X-ON Electronics

Largest Supplier of Electrical and Electronic Components

*Click to view similar products for [Transistor Output Optocouplers](#) category:*

*Click to view products by [Sharp](#) manufacturer:*

Other Similar products are found below :

[LTV-814S-TA](#) [LTV-824HS](#) [66095-001](#) [6N136-X017T](#) [MCT6-X007](#) [MOC8101-X017T](#) [PS2561A-1-W-A](#) [PS2561B-1-L-A](#) [PS2561L-1-V-A](#)  
[MRF658](#) [IL755-1X007](#) [ILD2-X006](#) [ILD74-X001](#) [ILQ615-2X017](#) [ILQ615-3X016](#) [LDA102S](#) [LDA110S](#) [PS2561-1-V-W-A](#) [PS2561AL-1-V-](#)  
[A](#) [PS2561L1-1-L-A](#) [PS2701A-1-F3-P-A](#) [PS2801-1-F3-P-A](#) [PS2911-1-L-AX](#) [CNY17-2X017](#) [CNY17-4X001](#) [CNY17-4X017](#) [CNY17F-](#)  
[1X007](#) [CNY17F-2X017](#) [CNY17F-4X001](#) [CNY17G-1](#) [LTV-214](#) [LTV-702VB](#) [LTV-733S](#) [LTV-816S-TA](#) [LTV-825S](#) [TCET1113](#) [TCET2100](#)  
[4N25-X007T](#) [IL215AT](#) [ILD615-1X007](#) [ILQ2-X007](#) [VOS615A-2T](#) [WPPC-A11066AA](#) [WPPC-A11066AD](#) [WPPC-A11084ASS](#) [WPPC-](#)  
[A21068AA](#) [WPPC-D11066AA](#) [WPPC-D21068ED](#) [WPPC-D410616EA](#) [WPPC-D410616ED](#)