



Surface Mount Schottky Barrier diode

FEATURES

- Fast switching .
- Low Turn-on voltage.
- PN Junction Guard Ring for Transient and ESD Protection.
- Available in Lead Free Version.
- MSL 3



Lead-free

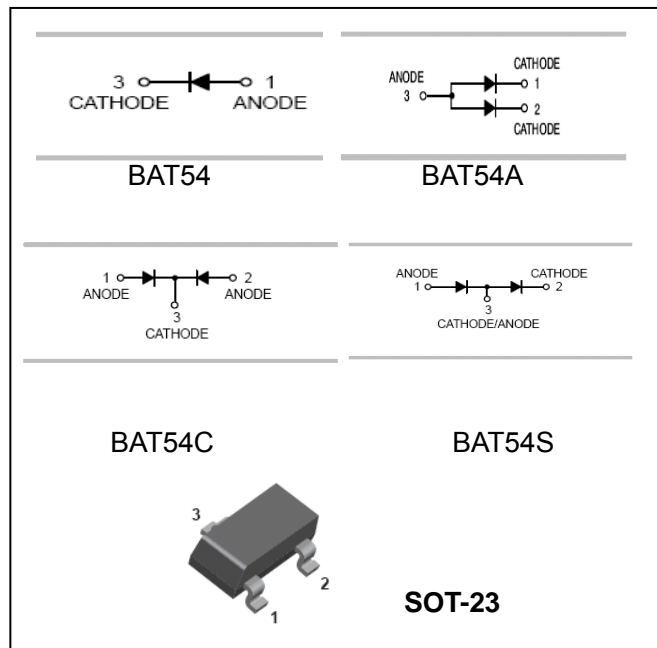

ORDERING INFORMATION

Type No.	Marking	Package Code
BAT54	KL1	SOT-23
BAT54A	KL2	SOT-23
BAT54C	KL3	SOT-23
BAT54S	KL4	SOT-23

MAXIMUM RATING @ Ta=25°C unless otherwise specified

Parameter	Symbol	Limits	Unit
Peak Repetitive Peak reverse voltage	V_{RRM}	30	V
Working Peak Reverse Voltage	V_{RWM}		
DC Reverse Voltage	V_R		
Forward Continuous Current	I_F	200	mA
Power Dissipation	P_d	225	mW
Thermal resistance, junction to ambient air	$R_{\theta JA}$	500	°C/W
Thermal resistance, junction to case	$R_{\theta Jc}$	360	°C/W
Operating and Storage temperature	T_J, T_{STG}	-55 to +150	°C



Surface Mount Schottky Barrier diode

ELECTRICAL CHARACTERISTICS @ Ta=25°C unless otherwise specified

Parameter	Symbol	Min.	Typ.	Max.	Unit	Conditions
Reverse Breakdown Voltage	$V_{(BR)}$	30			V	$I_R=100\mu A$
Forward voltage	V_{F1}			0.24	V	$I_F=0.1mA$
				0.32	V	$I_F=1mA$
				0.40	V	$I_F=10mA$
				0.50	V	$I_F=30mA$
				1	V	$I_F=100mA$
Reverse current	I_R			2	μA	$V_R=25V$
Diode Capacitance	C_D			10	pF	$V_R=1V, f=1MHz$
Reverse Recovery Time	t_{rr}			5	ns	$I_F=I_R=10mA$ $I_{rr}=0.1I_R, R_L=100\Omega$

TYPICAL CHARACTERISTICS @ Ta=25°C unless otherwise specified

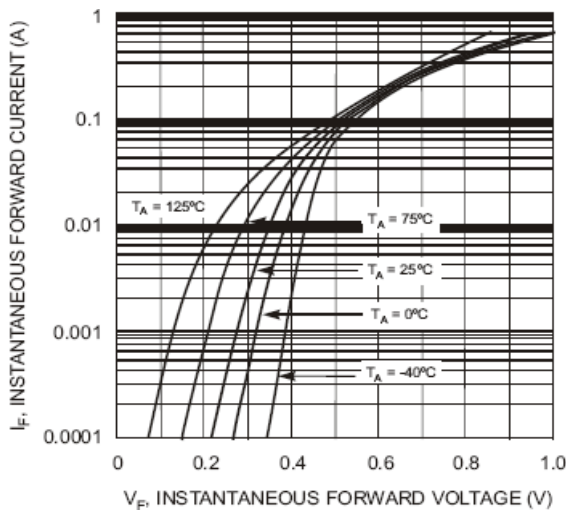

Fig. 1 Forward Characteristics

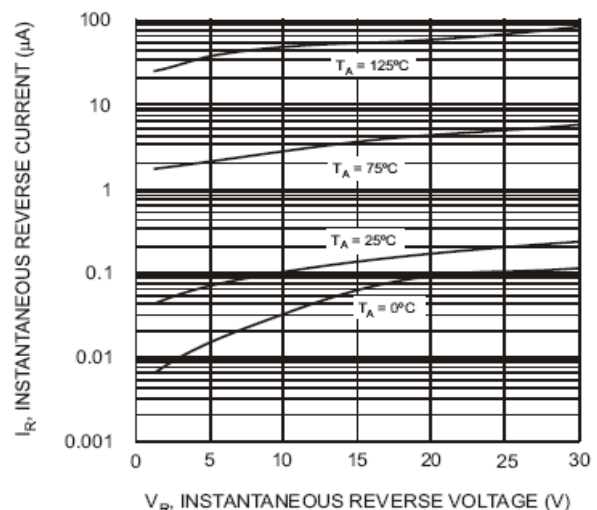

Fig. 2 Typical Reverse Characteristics

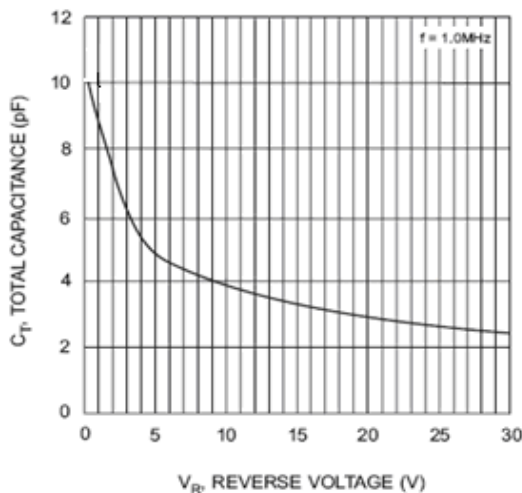

Fig. 3 Typical Capacitance vs. Reverse Voltage

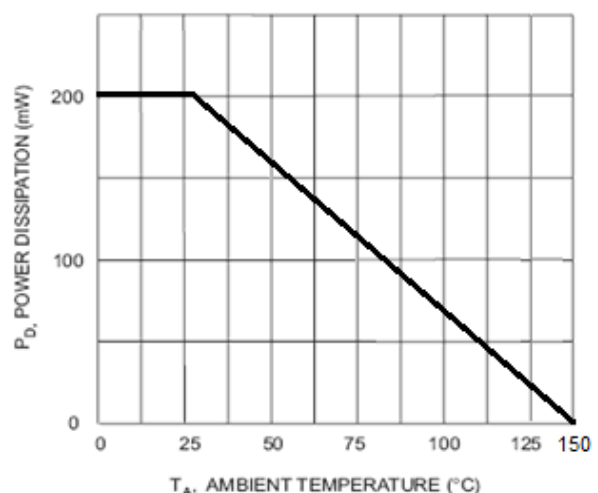

Fig. 4 Power Derating Curve



Surface Mount Schottky Barrier diode

PACKAGE OUTLINE

Plastic surface mounted package

SOT-23

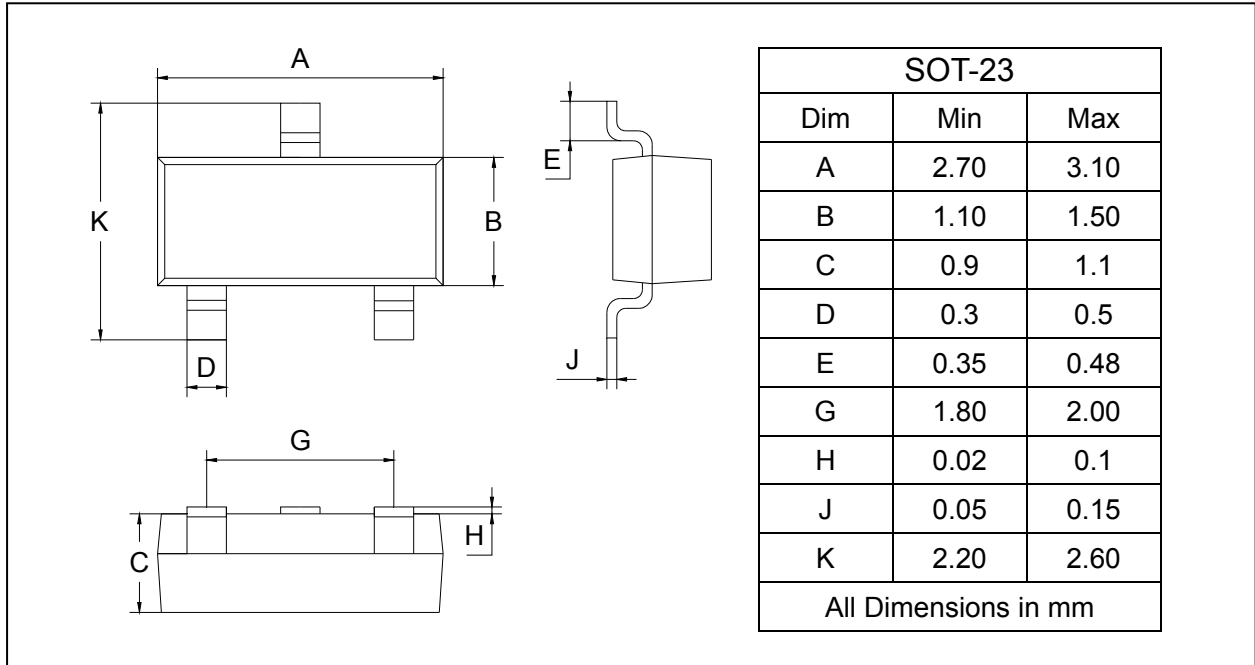

SOLDERING FOOTPRINT

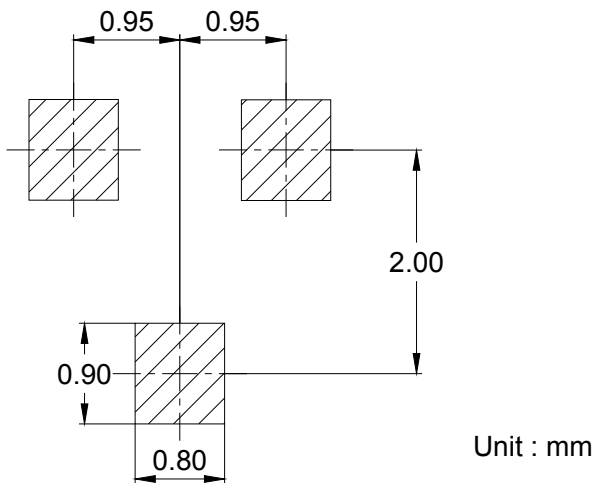

PACKAGE INFORMATION

Device	Package	Shipping
BAT54/A/C/S	SOT-23	3000/Tape&Reel

X-ON Electronics

Largest Supplier of Electrical and Electronic Components

Click to view similar products for [Schottky Diodes & Rectifiers](#) category:

Click to view products by [Shenzhen JingYang](#) manufacturer:

Other Similar products are found below :

[MA4E2039](#) [MMBD301M3T5G](#) [RB160M-50TR](#) [D83C](#) [BAS16E6433HTMA1](#) [BAS 3010S-02LRH E6327](#) [BAT 54-02LRH E6327](#)
[NRVBAF360T3G](#) [NSR05F40QNXT5G](#) [NTE555](#) [JANS1N6640](#) [SS3003CH-TL-E](#) [GA01SHT18](#) [CRS10I30A\(TE85L,QM](#) [MBRA140TRPBF](#)
[MBRB30H30CT-1G](#) [BAT 15-04R E6152](#) [JANTX1N5712-1](#) [DMJ3940-000](#) [SB007-03C-TB-E](#) [NRVBB20100CTT4G](#) [NRVBM120LT1G](#)
[NTSB30U100CT-1G](#) [CRG04\(T5L,TEMQ\)](#) [ACDBA1100LR-HF](#) [ACDBA1200-HF](#) [ACDBA240-HF](#) [ACDBA3100-HF](#) [CDBQC0530L-HF](#)
[ACDBA260LR-HF](#) [ACDBA1100-HF](#) [10BQ015-M3/5BT](#) [NRVBM120ET1G](#) [VSSB410S-M3/5BT](#) [1N5819T-G](#) [PDS1040Q-13](#) [B160BQ-13-F](#)
[SDM05U20CSP-7](#) [BAS 70-07 E6433](#) [B140S1F-7](#) [HSM560Je3/TR13](#) [DDB2265-000](#) [ZHCS506QTA](#) [HSM190Je3/TR13](#) [B330AF-13](#)
[ACDBUC0230-HF](#) [SDM1U100S1F-7](#) [MBR10200CTF-G1](#) [CDLL5712](#) [DMF2822-000](#)