

**SURFACE MOUNT
UNIDIRECTIONAL AND BIDIRECTIONAL
TRANSIENT VOLTAGE SUPPRESSORS**

STAND-OFF VOLTAGE - **4.0** to **200** Volts
POWER DISSIPATION - **400** WATTS

FEATURES

- For surface mounted applications
- Reliable low cost construction utilizing molded plastic technique
- Typical IR less than 1uA above 10V
- Fast response time: typically less than 1.0ns for Uni-direction, less than 5.0ns for Bi-direction, from 0 Volts to BV min
- RoHS compliant

MECHANICAL DATA

- Case : Molded plastic
- Case Material: Molding compound, UL Flammability classification 94V-0, (No Br. Sb. Cl.) "Halogen-free".
- Polarity : by cathode band denotes uni-directional device, none cathode band denotes bi-directional device
- Weight : 0.002 ounces, 0.064 gram

SMA

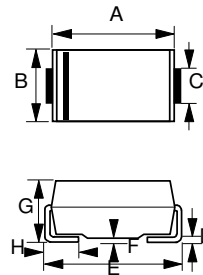

SMA		
DIM.	MIN.	MAX.
A	4.06	4.57
B	2.29	2.92
C	1.27	1.63
D	0.15	0.31
E	4.83	5.59
F	0.05	0.20
G	1.96	2.40
H	0.76	1.52

All Dimensions in millimeter

MAXIMUM RATINGS AND ELECTRICAL CHARACTERISTICS

Ratings at 25°C ambient temperature unless otherwise specified.

CHARACTERISTICS	SYMBOLS	VALUE	UNIT
PEAK POWER DISSIPATION AT TA = 25 °C, TP = 1ms (Note 1)	PPK	400	W
Peak Forward Surge Current 8.3ms single half sine-wave @ TJ = 25 °C (Note 2)	IFSM	40	A
Steady State Power Dissipation at TL = 120 °C	PM(AV)	1.0	W
Maximum Instantaneous forward voltage at 16A (Note 2, 3)	VF	3.0	V
Operating Temperature Range	TJ	-55 to +175	°C
Storage Temperature Range	TSTG	-55 to +175	°C

NOTES : 1. Non-repetitive current pulse, per fig. 3 and derated above TA= 25 °C per fig.1.
2. For unidirectional units only.
3. VF max=3V at IF=16 A 300us square wave pulse.

REV. 15, Jan-2016, KSIA02

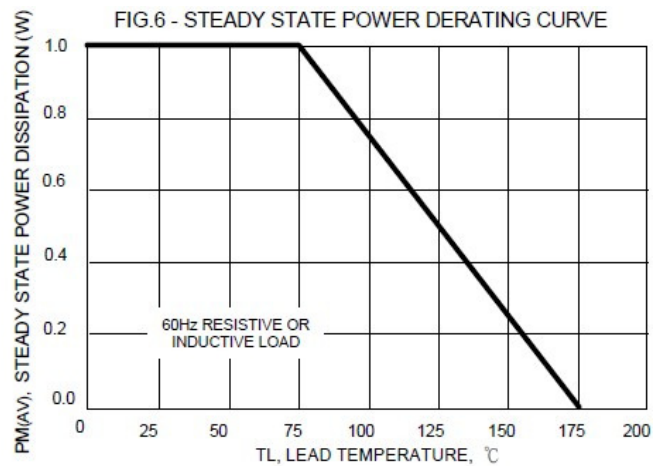
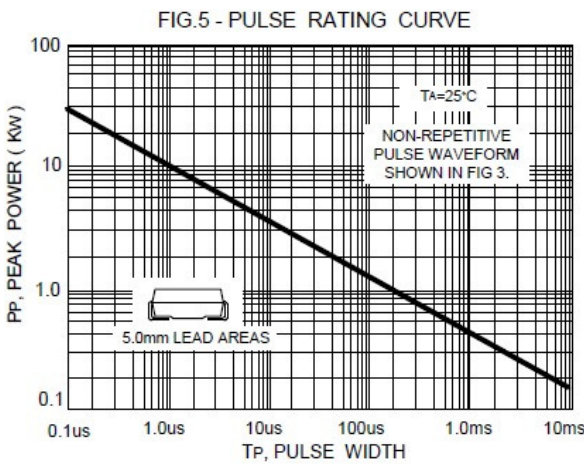
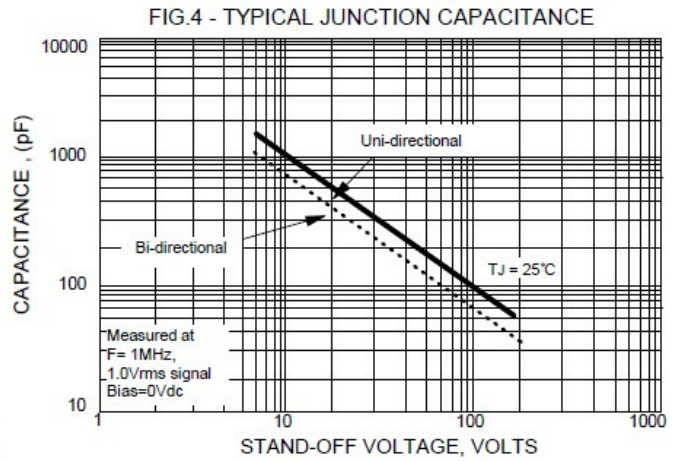
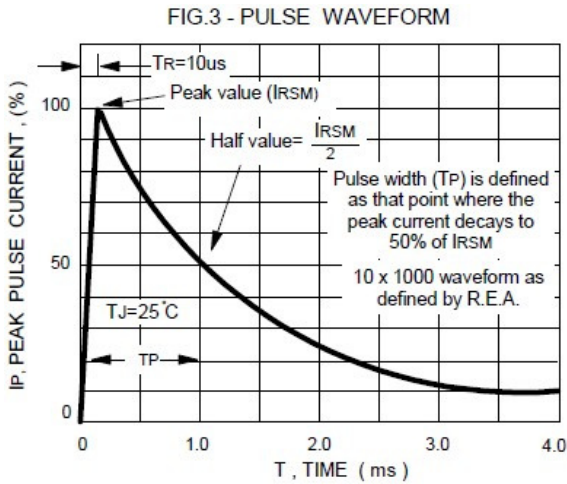
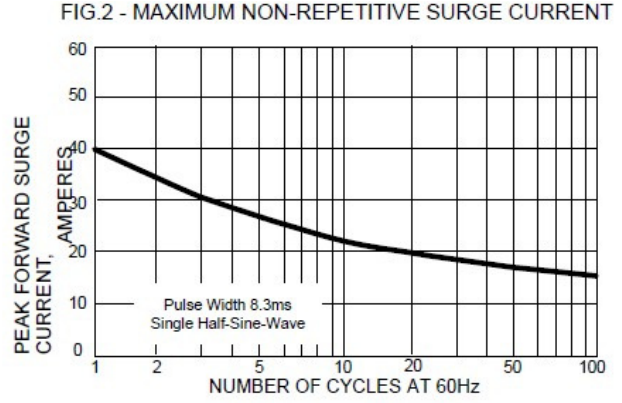
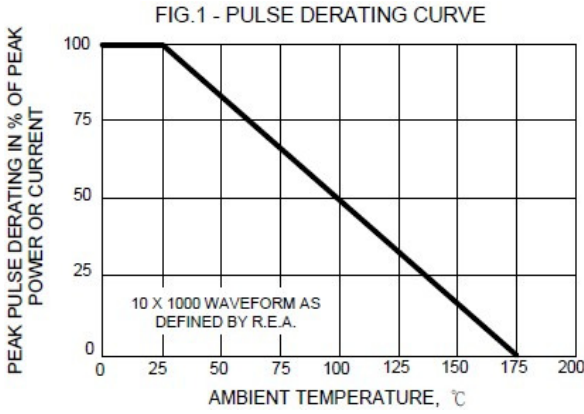

Device Uni-directional	Device Bi-directional	Device Marking code		Working Peak Reverse Voltage V _{RWM} (Volts)	Breakdown voltage VBR Volts			Maximum Reverse Voltage at I _{RSM} (Clamping Voltage) V _{RSM} (VOLTS)	Maximum Reverse Surge Current I _{RSM} (Amps)	Maximum Reverse Leakage at V _{RWM} IR (uA)
		(UNI)	(BI)		Min.	Max.	@IT(mA)			
SMAJ4.0		HB		4.0	5.40	6.50	10	8.6	46.5	1000
SMAJ5.0A	SMAJ5.0CA	HE	TE	5.0	6.40	7.07	10	9.2	43.5	800
SMAJ6.0A	SMAJ6.0CA	HG	TG	6.0	6.67	7.37	10	10.3	38.8	800
SMAJ6.5A	SMAJ6.5CA	HK	TK	6.5	7.22	7.98	10	11.2	35.7	500
SMAJ7.0A	SMAJ7.0CA	HM	TM	7.0	7.78	8.60	10	12.0	33.3	200
SMAJ7.5A	SMAJ7.5CA	HP	TP	7.5	8.33	9.21	1	12.9	31.0	100
SMAJ8.0A	SMAJ8.0CA	HR	TR	8.0	8.89	9.83	1	13.6	29.4	50
SMAJ8.5A	SMAJ8.5CA	HT	TT	8.5	9.44	10.43	1	14.4	27.7	10
SMAJ9.0A	SMAJ9.0CA	HV	TV	9.0	10.0	11.1	1	15.4	26.0	5
SMAJ10A	SMAJ10CA	HX	TX	10	11.1	12.3	1	17.0	23.5	5
SMAJ11A	SMAJ11CA	HZ	TZ	11	12.2	13.5	1	18.2	22.0	0.5
SMAJ12A	SMAJ12CA	IE	UE	12	13.3	14.7	1	19.9	20.1	0.5
SMAJ13A	SMAJ13CA	IG	UG	13	14.4	15.9	1	21.5	18.6	0.5
SMAJ14A	SMAJ14CA	IK	UK	14	15.6	17.2	1	23.2	17.2	0.5
SMAJ15A	SMAJ15CA	IM	UM	15	16.7	18.5	1	24.4	16.4	0.5
SMAJ16A	SMAJ16CA	IP	UP	16	17.8	19.7	1	26.0	15.3	0.5
SMAJ17A	SMAJ17CA	IR	UR	17	18.9	20.9	1	27.6	14.5	0.5
SMAJ18A	SMAJ18CA	IT	UT	18	20.0	22.1	1	29.2	13.7	0.5
SMAJ20A	SMAJ20CA	IV	UV	20	22.2	24.5	1	32.4	12.3	0.5
SMAJ22A	SMAJ22CA	IX	UX	22	24.4	27.0	1	35.5	11.2	0.5
SMAJ24A	SMAJ24CA	IZ	UZ	24	26.7	29.5	1	38.9	10.3	0.5
SMAJ26A	SMAJ26CA	JE	VE	26	28.9	31.9	1	42.1	9.5	0.5
SMAJ28A	SMAJ28CA	JG	VG	28	31.1	34.4	1	45.4	8.8	0.5
SMAJ30A	SMAJ30CA	JK	VK	30	33.3	36.8	1	48.4	8.3	0.5
SMAJ33A	SMAJ33CA	JM	VM	33	36.7	40.6	1	53.3	7.5	0.5
SMAJ36A	SMAJ36CA	JP	VP	36	40.0	44.2	1	58.1	6.9	0.5
SMAJ40A	SMAJ40CA	JR	VR	40	44.4	49.1	1	64.5	6.2	0.5
SMAJ43A	SMAJ43CA	JT	VT	43	47.8	52.8	1	69.4	5.7	0.5
SMAJ45A	SMAJ45CA	JV	VV	45	50.0	55.3	1	72.7	5.5	0.5
SMAJ48A	SMAJ48CA	JX	VX	48	53.3	58.9	1	77.4	5.2	0.5
SMAJ51A	SMAJ51CA	JZ	VZ	51	56.7	62.7	1	82.4	4.9	0.5
SMAJ54A	SMAJ54CA	RE	WE	54	60.0	66.3	1	87.1	4.6	0.5
SMAJ58A	SMAJ58CA	RG	WG	58	64.4	71.2	1	93.6	4.3	0.5
SMAJ60A	SMAJ60CA	RK	WK	60	66.7	73.7	1	96.8	4.1	0.5
SMAJ64A	SMAJ64CA	RM	WM	64	71.1	78.6	1	103	3.9	0.5
SMAJ70A	SMAJ70CA	RP	WP	70	77.8	86.0	1	113	3.5	0.5
SMAJ75A	SMAJ75CA	RR	WR	75	83.3	92.1	1	121	3.3	0.5
SMAJ78A	SMAJ78CA	RT	WT	78	86.7	95.8	1	126	3.2	0.5
SMAJ85A	SMAJ85CA	RV	VV	85	94.4	104	1	137	2.9	0.5
SMAJ90A	SMAJ90CA	RX	WX	90	100	111	1	146	2.7	0.5
SMAJ100A	SMAJ100CA	RZ	WZ	100	111	123	1	162	2.5	0.5
SMAJ110A	SMAJ110CA	SE	XE	110	122	135	1	177	2.3	0.5
SMAJ120A	SMAJ120CA	SG	XG	120	133	147	1	193	2.0	0.5
SMAJ130A	SMAJ130CA	SK	XK	130	144	159	1	209	1.9	0.5
SMAJ150A	SMAJ150CA	SM	XM	150	167	185	1	243	1.6	0.5
SMAJ160A	SMAJ160CA	SP	XP	160	178	197	1	259	1.5	0.5
SMAJ170A	SMAJ170CA	SR	XR	170	189	209	1	275	1.4	0.5
SMAJ188A	SMAJ188CA	SS	VS	188	209	231	1	328	1.2	0.5
SMAJ200A	SMAJ200CA	ST	YT	200	224	248	1	324	1.2	0.5

NOTE :

Suffix 'A ' denotes 5% tolerance device.

1. Add suffix 'C ' or ' CA ' after part number to specify Bi-directional devices.
2. The IR limit is double for Bi-Directional devices.

Important Notice and Disclaimer

LSC reserves the right to make changes to this document and its products and specifications at any time without notice. Customers should obtain and confirm the latest product information and specifications before final design, purchase or use.

LSC makes no warranty, representation or guarantee regarding the suitability of its products for any particular purpose, nor does LSC assume any liability for application assistance or customer product design. LSC does not warrant or accept any liability with products which are purchased or used for any unintended or unauthorized application.

No license is granted by implication or otherwise under any intellectual property rights of LSC.

LSC products are not authorized for use as critical components in life support devices or systems without express written approval of LSC.

X-ON Electronics

Largest Supplier of Electrical and Electronic Components

Click to view similar products for [ESD Suppressors / TVS Diodes](#) category:

Click to view products by [Shenzhen JingYang](#) manufacturer:

Other Similar products are found below :

[60KS200C](#) [D18V0L1B2LP-7B](#) [D5V0F4U5P5-7](#) [NTE4902](#) [P4KE27CA](#) [P6KE11CA](#) [P6KE8.2A](#) [SA60CA](#) [SA64CA](#) [SMBJ12CATR](#)
[SMBJ33CATR](#) [SMBJ6.5A](#) [SMBJ8.0A](#) [ESD101-B1-02ELS E6327](#) [ESD112-B1-02EL E6327](#) [ESD7451N2T5G](#) [19180-510](#) [CPDT-5V0USP-](#)
[HF](#) [3.0SMCJ33CA-F](#) [3.0SMCJ36A-F](#) [HSPC16701B02TP](#) [JANTX1N6126A](#) [D3V3Q1B2DLP3-7](#) [D55V0M1B2WS-7](#) [SCM1293A-04SO](#)
[ESD200-B1-CSP0201 E6327](#) [SM12-7](#) [CEN955 W/DATA](#) [VESD12A1A-HD1-GS08](#) [CPDQC5V0-HF](#) [D1213A-01LP4-7B](#) [ESD101-B1-02EL](#)
[E6327](#) [AOZ8808DI-03](#) [5KP15A](#) [5KP48A](#) [5KP90A](#) [ESD3V3D7-TP](#) [15KPA36A-LF](#) [P4KE56CA](#) [P4KE68A](#) [P4KE91CATR](#) [P6KE120A](#)
[P6KE13CA](#) [P6KE43CA](#) [P6KE6.8CA](#) [P6KE8.2](#) [P6SMBJ20CA](#) [JANTX1N6072A](#) [SR2835ESKG](#) [SA90CA](#)