

## Features

- ❑ High Efficiency: Up to 98%
- ❑ 600KHz Frequency Operation
- ❑ 2A Output Current
- ❑ No Schottky Diode Required
- ❑ 4.0V to 18V Input Voltage Range
- ❑ 0.6V Reference
- ❑ Slope Compensated Current Mode Control for Excellent Line and Load Transient Response
- ❑ Integrated internal compensation
- ❑ Stable with Low ESR Ceramic Output Capacitors
- ❑ Over Current Protection with Hiccup-Mode
- ❑ Thermal Shutdown
- ❑ Inrush Current Limit and Soft Start
- ❑ Available in SOT23-6 Package
- ❑ -40°C to +85°C Temperature Range

## Description

The TD8112X is a fully integrated, high efficiency 2A synchronous rectified step-down converter. The TD8112X operates at high efficiency over a wide output current load range. This device offers two operation modes, PWM control and PFM Mode switching control, which allows a high efficiency over the wider range of the load. The TD8112X requires a minimum number of readily available standard external components and is available in a 6-pin SOT23-6 compliant package.

## Applications

- ❑ Distributed Power Systems
- ❑ Digital Set Top Boxes
- ❑ Flat Panel Television and Monitors
- ❑ Wireless and DSL Modems
- ❑ Notebook Computer

VOUT	R1	R2
5.0V	50K	6.8K
3.3V	50K	11K
1.8V	50K	25K
1.5V	50K	33.3K
1.2V	50K	50K
1.0V	50K	75K

**The recommended divider resistor setup for the output voltage**

## Pin Configuration

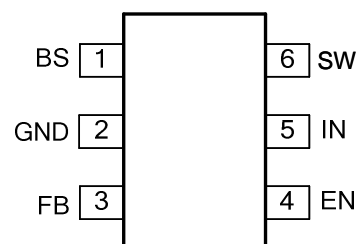

**TD8112X (SOT23-6)**

**Absolute Maximum Rating (Note 1)**

VIN, EN Voltage .....	-0.3V to 18V	SW Voltage .....	-0.3V to (VIN+0.5V)
Operating Temperature Range ...	-40°C to +85°C	Storage Temperature Range .....	-65°C to 150°C
FB Voltages .....	-0.3 to 6V	BS Voltage .....	(Vsw-0.3) to (Vsw+5V)
Lead Temperature (Soldering, 10s) .....	+300°C		

**PIN DESCRIPTION**

PIN	NAME	FUNCTION
1	BS	Bootstrap. A capacitor connected between SW and BST pins is required to form a floating supply across the high-side switch driver.
2	GND	GROUND Pin
3	FB	Adjustable Version Feedback input. Connect FB to the center point of the external resistor divider
4	EN	Drive this pin to a logic-high to enable the IC. Drive to a logic-low to disable the IC and enter micro-power shutdown mode.
5	IN	Power Supply Pin
6	SW	Switching Pin

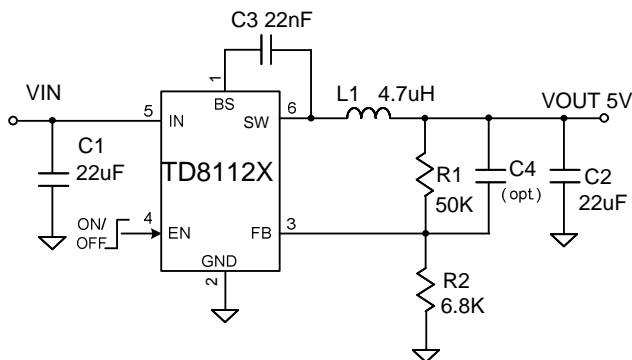
**TYPICAL APPLICATION**

**Figure 1. Basic Application Circuit for VOUT=5V**

**Electrical Characteristics (Note3)**

( $V_{IN}=12V$ ,  $V_{OUT}=5V$ ,  $T_A = 25^{\circ}C$ , unless otherwise noted.)

Parameter	Conditions	MIN	TYP	MAX	unit
Input Voltage Range		4		18	V
Supply Current in Operation	$V_{EN}=3.0V$ , $V_{FB}=1.1V$		0.4	0.8	mA
Supply Current in Shutdown	$V_{EN} = 0$ or $EN = GND$		5		$\mu A$
Regulated Feedback Voltage	$T_A = 25^{\circ}C$ , $4.5V \leq V_{IN} \leq 18V$	0.588	0.6	0.612	V
High-Side Switch On-Resistance			90		m $\Omega$
Low-Side Switch On-Resistance			70		m $\Omega$
High-Side Switch Leakage Current	$V_{EN}=0V$ , $V_{SW}=0V$		0	10	$\mu A$
Upper Switch Current Limit	Minimum Duty Cycle		3		A
Oscillation Frequency			0.6		MHz
Maximum Duty Cycle	$V_{FB}=0.6V$		92		%
Minimum On-Time			60		nS
Minimum Off-Time			100		nS
Thermal Shutdown			160		$^{\circ}C$
Thermal Shutdown Hysteresis			20		$^{\circ}C$

**TYPICAL PERFORMANCE CHARACTERISTICS**

(VIN = 12V, L = 4.7μH, TA = 25°C, unless otherwise noted.)

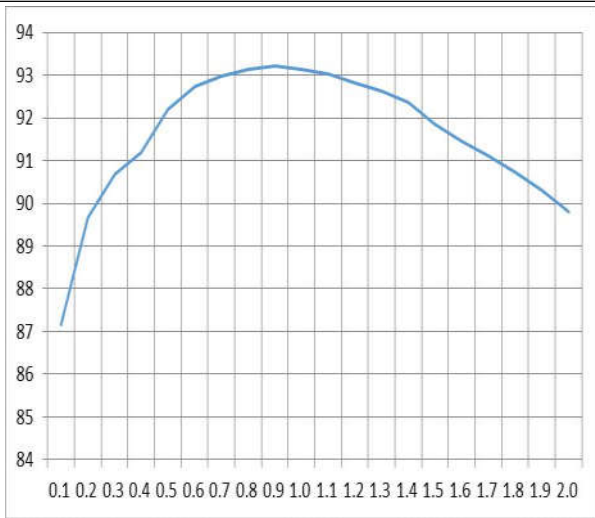

The efficiency for VOUT=5V

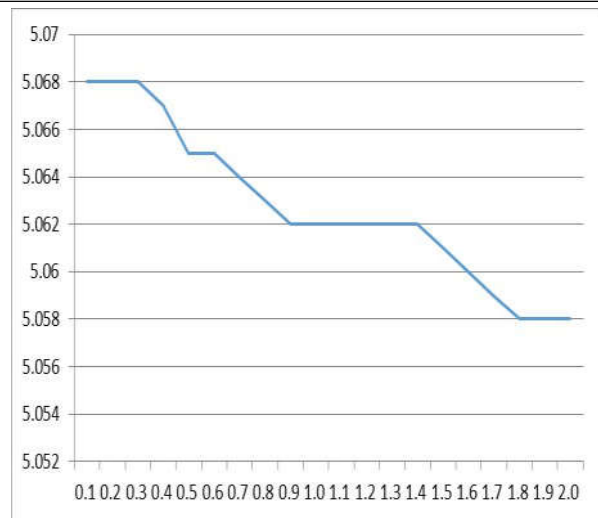

The Load Regulation for VOUT=5V

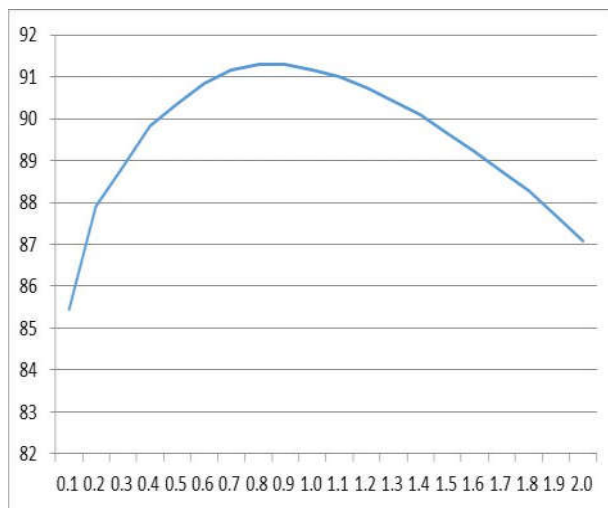

The efficiency for VOUT=3.3V

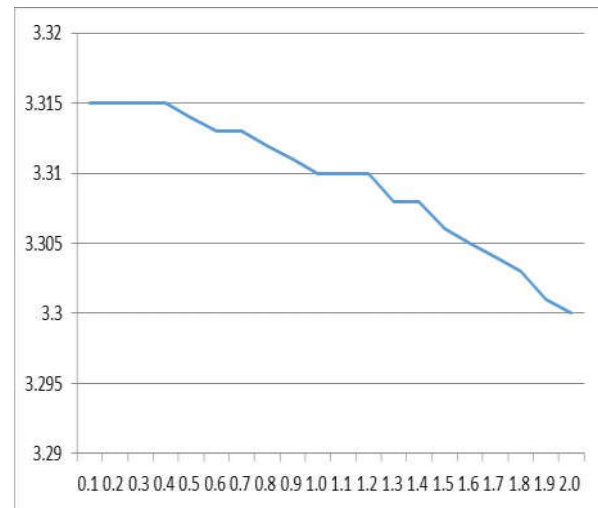

The Load Regulation For VOUT=3.3V

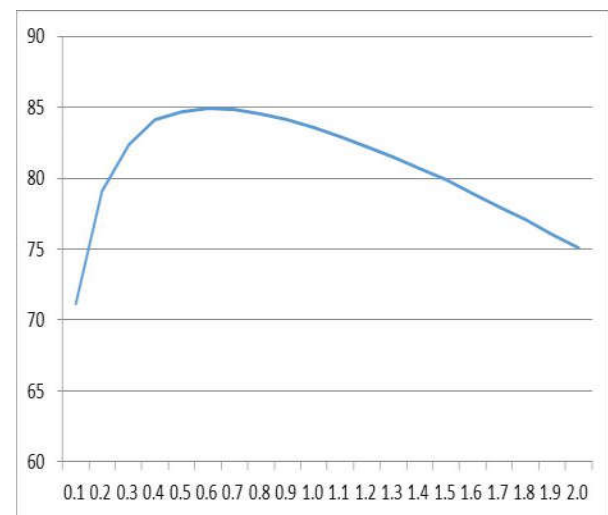

The Efficiency For VOUT=1.2V

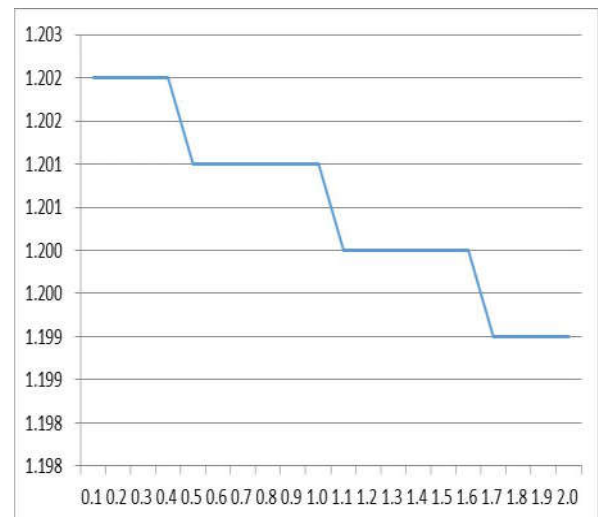

The Load Regulation For VOUT=1.2V

## FUNCTIONAL BLOCK DIAGRAM

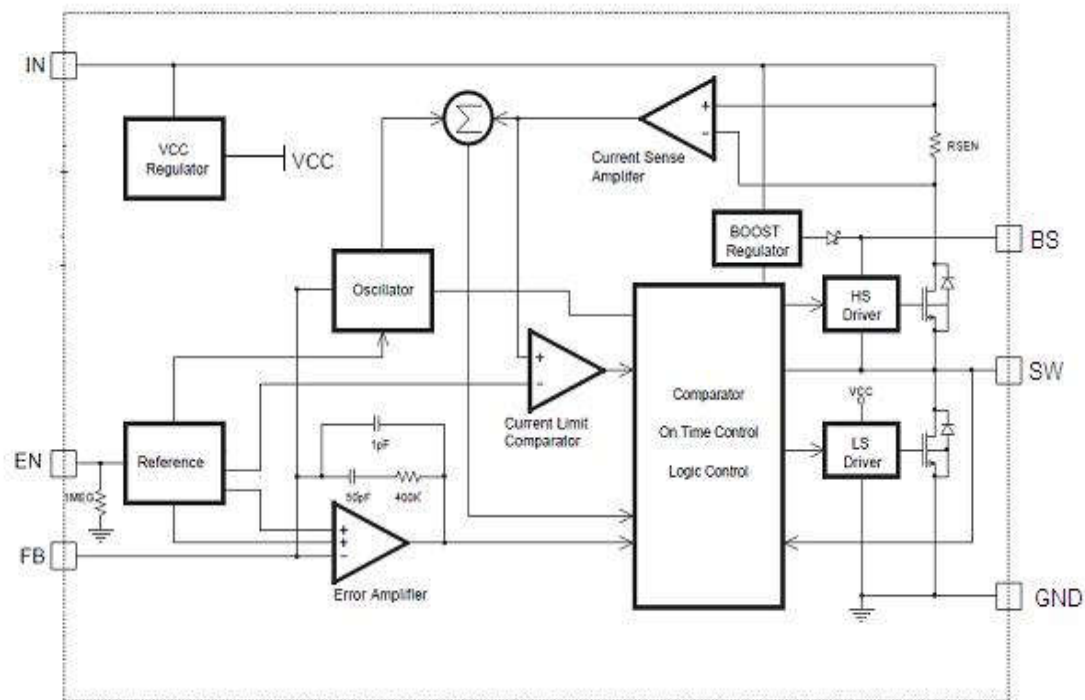

Figure 2. TD8112 Block Diagram

## FUNCTIONAL DESCRIPTION

### Internal Regulator

The TD8112 is a current mode step down DC/DC converter that provides excellent transient response with no extra external compensation components. This device contains an internal, low resistance, high voltage power MOSFET, and operates at a high 600K operating frequency to ensure a compact, high efficiency design with excellent AC and DC performance.

### Error Amplifier

The error amplifier compares the FB pin voltage with the internal FB reference (VFB) and outputs a current proportional to the difference between the two. This output current is then used to charge or

discharge the internal compensation network to form the COMP voltage, which is used to control the power MOSFET current. The optimized internal compensation network minimizes the external component counts and simplifies the control loop design.

### Internal Soft-Start

The soft-start is implemented to prevent the converter output voltage from overshooting during startup. When the chip starts, the internal circuitry generates a soft-start voltage (SS) ramping up from 0V to 0.81V. When it is lower than the internal reference (REF), SS overrides REF so the error amplifier uses SS as the reference. When SS is higher than REF, REF regains control. The SS time is internally fixed to 1.5 ms.

## Over Current Protection & Hiccup

The TD8112 has cycle-by-cycle over current limit when the inductor current peak value exceeds the set current limit threshold. Meanwhile, output voltage starts to drop until FB is below the Under-Voltage (UV) threshold, typically 30% below the reference. Once a UV is triggered, the TD8112 enters hiccup mode to periodically restart the part. This protection mode is especially useful when the output is dead-short to ground. The average short circuit current is greatly reduced to alleviate the thermal issue and to protect the regulator. The TD8112 exits the hiccup mode once the over current condition is removed.

## Startup and Shutdown

If both VIN and EN are higher than their appropriate thresholds, the chip starts. The reference block starts first, generating stable reference voltage and currents, and then the internal regulator is enabled. The regulator provides stable supply for the remaining circuitries. Three events can shut down the chip: EN low, VIN low and thermal shutdown. In the shutdown procedure, the signaling path is first blocked to avoid any fault triggering. The COMP voltage and the internal supply rail are then pulled down. The floating driver is not subject to this shutdown command.

## PCB Layout Guide

PCB layout is very important to achieve stable operation. It is highly recommended to duplicate EVB layout for optimum performance. If change is necessary, please follow these guidelines and take Figure 4 for reference.

- 1) Keep the path of switching current short and minimize the loop area formed by Input capacitor, high-side MOSFET and low-side MOSFET.
- 2) Bypass ceramic capacitors are suggested to be put close to the Vin Pin.

- 3) Ensure all feedback connections are short and direct. Place the feedback resistors and compensation components as close to the chip as possible.
- 4) VOUT, SW away from sensitive analog areas such as FB.
- 5) Connect IN, SW, and especially GND respectively to a large copper area to cool the chip to improve thermal performance and long-term reliability.
- 6) An example of 2-layer PCB layout is shown in Figure 4 for reference.

## APPLICATION INFORMATION

### Setting the Output Voltage

The external resistor divider is used to set the output voltage (see Typical Application on page 1). The feedback resistor R1 also sets the feedback loop bandwidth with the internal compensation capacitor. Choose R1 to be around 50kΩ for optimal transient response. R2 is then given by:

$$R_2 = \frac{R_1}{V_{out} / V_{FB} - 1}$$

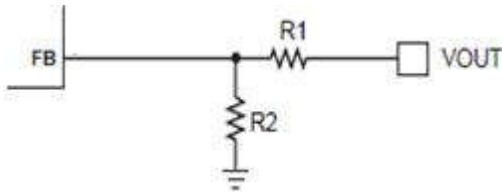

### Selecting the Inductor

A 4.7μH to 22μH inductor with a DC current rating of at least 25% percent higher than the maximum load current is recommended for most applications. For highest efficiency, the inductor DC resistance should be less than 15mΩ. For most designs, the inductance value can be derived from the following equation.

$$L = \frac{V_{out} \times (V_{in} - V_{out})}{V_{in} \times \Delta I_L \times f_{OSC}}$$

Where ΔIL is the inductor ripple current. Choose inductor ripple current to be approximately 30% of the maximum load current, 2A. The maximum inductor peak current is:

$$I_{L(MAX)} = I_{LOAD} + \frac{\Delta I_L}{2}$$

Under light load conditions below 100mA, larger inductance is recommended for improved efficiency.

### Selecting the Output Capacitor

The output capacitor (C2) is required to maintain the DC output voltage. Ceramic, tantalum, or low ESR electrolytic capacitors are recommended. Low ESR capacitors are preferred to keep the output voltage ripple low. The output voltage ripple can be estimated by:

$$\Delta V_{OUT} = \frac{V_{OUT}}{f_s \times L} \times \left[ 1 - \frac{V_{OUT}}{V_{IN}} \right] \times \left[ R_{ESR} + \frac{1}{8 \times f_s \times C_2} \right]$$

Where L is the inductor value and RESR is the equivalent series resistance (ESR) value of the output capacitor. In the case of ceramic capacitors, the impedance at the switching frequency is dominated by the capacitance. The output voltage ripple is mainly caused by the capacitance. For simplification, the output voltage ripple can be estimated by:

$$\Delta V_{OUT} = \frac{V_{OUT}}{8 \times f_s^2 \times L \times C_2} \times \left[ 1 - \frac{V_{OUT}}{V_{IN}} \right]$$

In the case of tantalum or electrolytic capacitors, the ESR dominates the impedance at the switching frequency. For simplification, the output ripple can be approximated to:

$$\Delta V_{OUT} = \frac{V_{OUT}}{f_s \times L} \times \left[ 1 - \frac{V_{OUT}}{V_{IN}} \right] \times R_{ESR}$$

The characteristics of the output capacitor also affect the stability of the regulation system. The TD8112 can be optimized for a wide range of capacitance and ESR values.

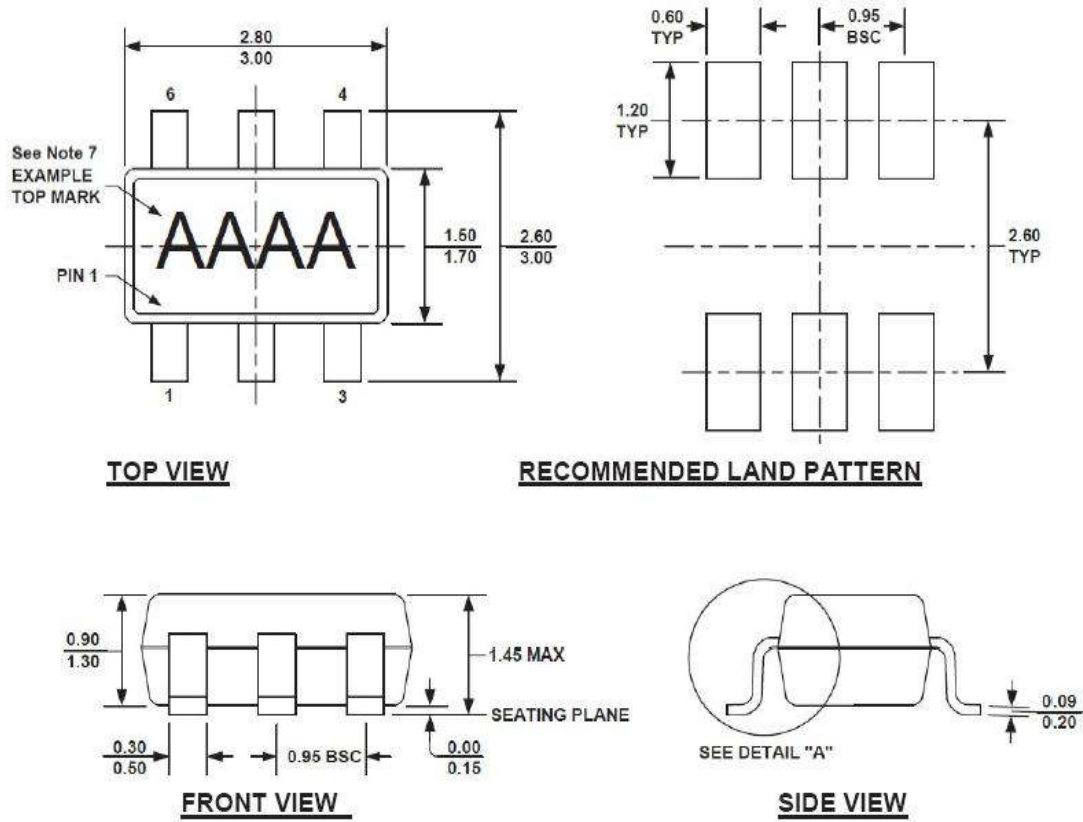
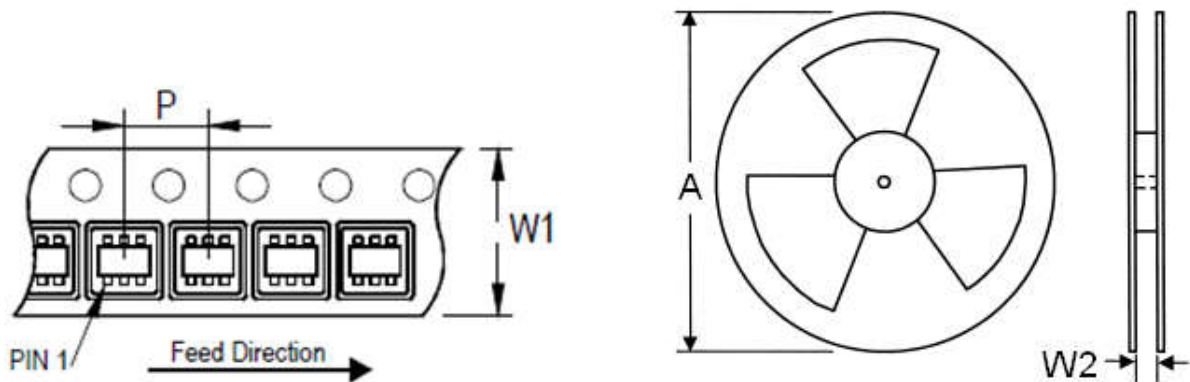

**PACKAGE INFORMATION**

**Carrier Dimensions**

Tape Size (W1) mm	Pocket Pitch (P) mm	Reel Size (A)		Reel Width (W2) mm	Empty Cavity Length mm	Units per Reel
		in	mm			
8	4	7	180	8.4	300~1000	3,000

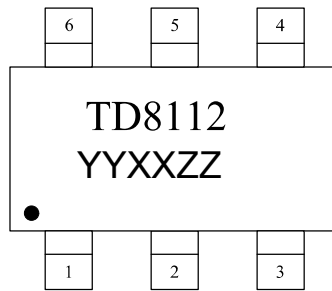

**Marking Codes**

(1)

**Note:**

- (1) TD8112X: Part number, fixed
- (Y): Assembly year
- XX: Assembly week ZZ: Internal code

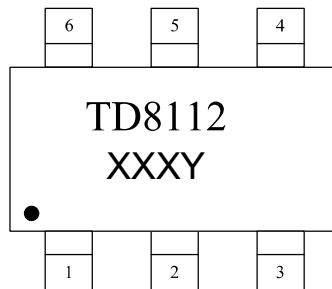

(2)

**Note:**

- (1) TD8112X: Part number, fixed
- (2) XXX: Wafer's Lot No Y: Internal Code

## X-ON Electronics

Largest Supplier of Electrical and Electronic Components

*Click to view similar products for [Isolated DC/DC Converters](#) category:*

*Click to view products by [Shenzhen JingYang](#) manufacturer:*

Other Similar products are found below :

[PSL486-7LR](#) [Q48T30020-NBB0](#) [JAHW100Y1](#) [SPB05C-12](#) [SQ24S15033-PS0S](#) [CE-1003](#) [CE-1004](#) [MAU228](#) [J80-0041NL](#) [DFC15U48D15](#)  
[XGS-1205](#) [06322](#) [SPB05B-15](#) [L-DA20](#) [DCG40-5G](#) [XKS-2405](#) [DPA423R](#) [vi-m13-cw-03](#) [VI-L53-CV](#) [24IBX15-50-0ZG](#) [HZZ01204-G](#)  
[SPU02L-09](#) [SPU02M-09](#) [SPU02N-09](#) [QUINT4-BUFFER/24DC/40](#) [QUINT4-CAP/24DC/5/4KJ](#) [73-551-5039I](#) [DFC15U48D15G](#) [SEN-6471-](#)  
[1EM](#) [AHV2815DF/HBB](#) [MI-LC21-IX](#) [PAH-48/8.5-D48NB1-C](#) [BM3020-7A](#) [QRS2050P025R06](#) [QRS2050P025K00](#) [CM2320-9EG](#)  
[SKMW15F-05](#) [V300A28H400BF3](#) [TEN 15-1223](#) [TEQ 100-2418WIR](#) [TEQ 160-7218WIR](#) [R05C05TE05S-R](#) [HQA2W085W033V-N07-S](#)  
[AM1SS-2405SJZ](#) [AM2DS-1224SJZ](#) [AM2DS-2405DJZ](#) [AM10SBO-4824SNZ-B](#) [AM15E-2405S-NZ](#) [AM2DS-1212SJZ](#) [AM30SBO-](#)  
[4805SNZ-B](#)