

Features

- ❑ Transient protection for high-speed data lines
IEC 61000-4-2 (ESD) ±25kV (Air)
±17kV (Contact)
IEC 61000-4-4 (EFT) 40A (5/50 ns)
Cable Discharge Event (CDE)
- ❑ Package optimized for high-speed lines
- ❑ Ultra-small package (2.5mm×1.0mm×0.55mm)
- ❑ Protects four data lines
- ❑ Low capacitance: 0.25pF (Typical)
- ❑ Low leakage current: 0.1μA @ V_{RWM} (Maximum)
- ❑ Low clamping voltage
- ❑ Each I/O pin can withstand over 1000 ESD strikes for ±8kV contact discharge
- ❑ ROHS compliant

Description

TT0334SPX is an ultra-low capacitance Transient Voltage Suppressor (TVS) designed to provide electrostatic discharge (ESD) protection for high-speed data interfaces. With Typical capacitance 0.25pF only, TT0334SPX is designed to protect parasitic-sensitive systems against over-voltage and over-current transient events. It complies with IEC 61000-4-2 (ESD), Level 4 (±15kV air, ±8kV contact discharge), IEC 61000-4-4 (electrical fast transient - EFT) (40A, 5/50 ns), very fast charged device model (CDM) ESD and cable discharge event (CDE), etc.

TT0334SPX uses ultra-small DFN-10L package. Each TT0334SPX device can protect four high-speed data lines. The combined features of ultra-low capacitance, ultra-small size and high ESD robustness make TT0334SPX ideal for high-speed data ports and high-frequency lines (e.g., HDMI & DVI) applications. The low clamping voltage of the TT0334SPX guarantees a minimum stress on the protected IC.

Applications

- ❑ Serial ATA
- ❑ PCI Express
- ❑ Desktops, Servers and Notebooks
- ❑ MDDI Ports
- ❑ USB 2.0/3.0/3.1 Power and Data Line Protection
- ❑ Display Ports
- ❑ High Definition Multi-Media Interface (HDMI)
- ❑ Digital Visual Interfaces (DVI)

Mechanical Characteristics

- ❑ DFN-10L package
- ❑ Flammability Rating: UL 94V-0
- ❑ Marking: Part number
- ❑ Packaging: Tape and Reel

Circuit Diagram

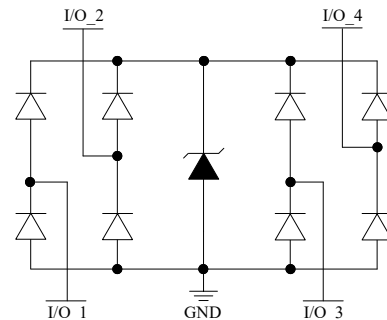

Pin Configuration

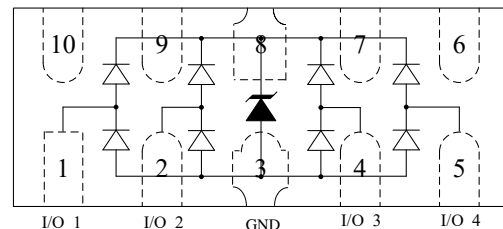

DFN-10L
(Top View)



Absolute Maximum Rating

Symbol	Parameter	Value	Units
I_{PP}	Peak Pulse Current($t_p=8/20\mu s$)	3.0	A
V_{ESD}	ESD per IEC 61000-4-2(Air) ESD per IEC 61000-4-2 (Contact)	± 25 ± 17	kV
T_{OPT}	Operating Temperature	-55/+125	°C
T_{STG}	Storage Temperature	-55/+150	°C

Electrical Characteristics (T = 25°C)

Symbol	Test Condition	Minimum	Typical	Maximum	Units
V_{RWM}				3.3	V
I_R	$V_{RWM} = 3.3V, T = 25^\circ C$		0.01	0.1	μA
V_{t1}	$I_{t1} = 100\mu A$	6.0		8.0	V
V_h	$I_h = 10mA$	3.5		5.5	V
V_C	$I_{PP} = 3.0A, t_p = 8/20\mu s$		8.5		V
C_{ESD}	$V_R = 0V, f = 1MHz$ Between I/O and GND		0.25	0.35	pF
C_{ESD}	$V_R = 0V, f = 1MHz$ Between I/O and I/O		0.15	0.25	pF

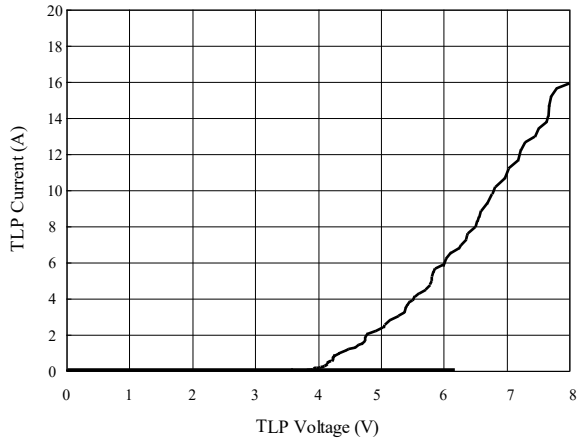
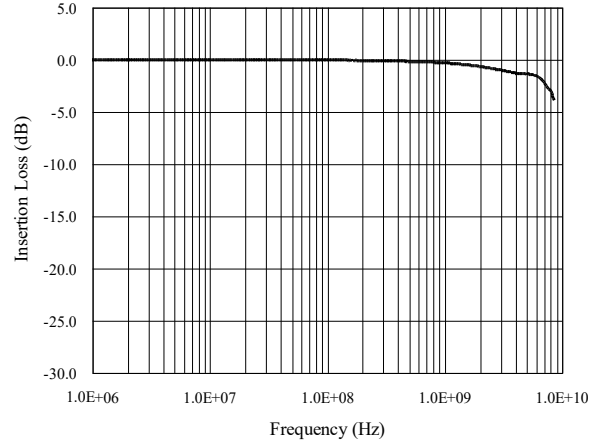
TLP Measurement of I/O to GND

Insertion Loss S21 of I/O to GND

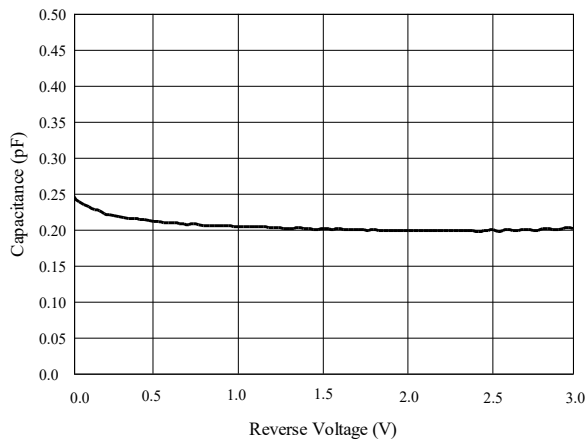
Capacitance vs. Voltage of I/O to GND (f = 1MHz)

Capacitance vs. Reverse Voltage

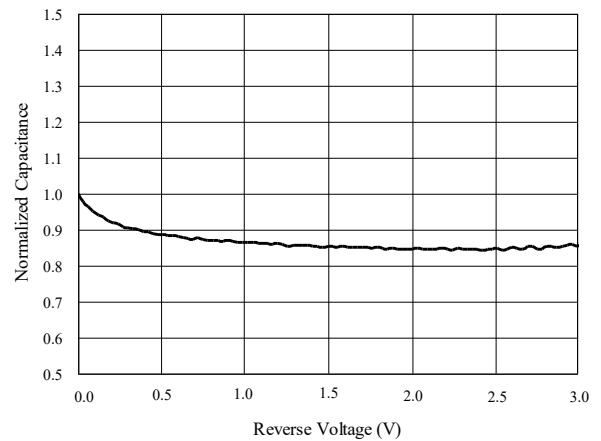
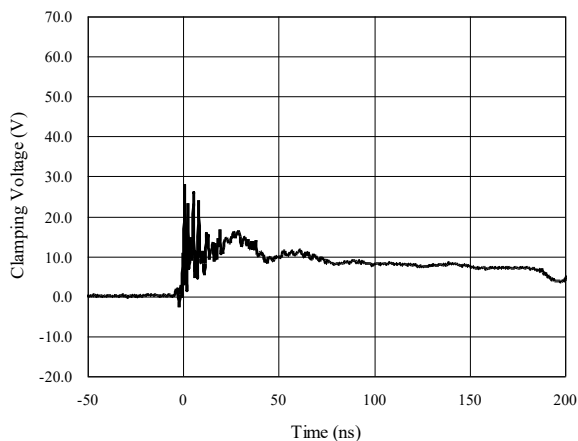
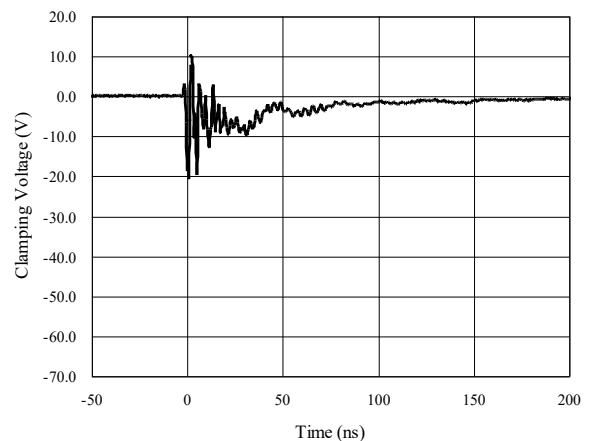

Normalized Capacitance vs. Reverse Voltage

ESD Clamping of I/O to GND (+8kV Contact per IEC 61000-4-2)

ESD Clamping of I/O to GND (-8kV Contact per IEC 61000-4-2)

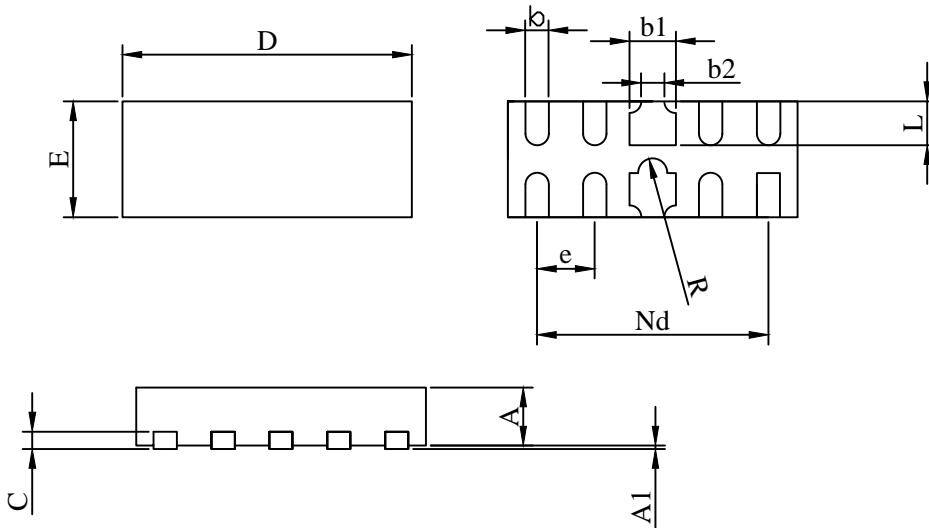

Package Outline

- DFN-10L package
- Thermally-Enhanced
- MSL-1 Level



SYMBOL	MILLIMETER		
	MIN	NOM	MAX
L			
D	2.45	2.50	2.55
E	0.95	1.00	1.05
b1	0.35	0.40	0.45
b2	0.20REF		
b	0.15	0.20	0.25
L	0.33	0.38	0.43
Nd	2.00REF		
e	0.50REF		
R	0.10	0.125	0.15
A	0.45	0.50	0.55
c	0.15REF		
A1	0.00	-	0.05

Tape and Reel Specification

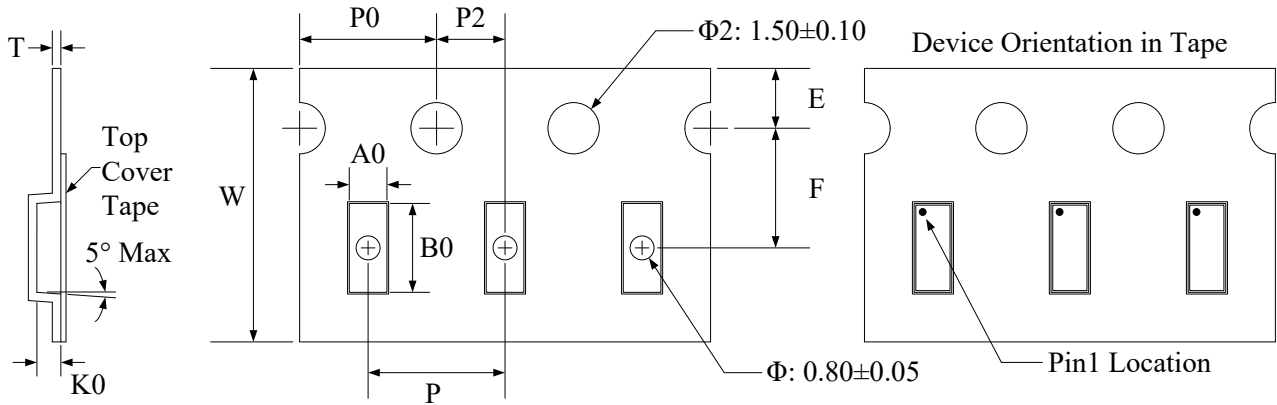

Symbol	W	A0	B0	K0	E	F	P	P0	P2	T
Dimensions (mm)	8.00+0.3 -0.1	1.23±0.05	2.7±0.05	0.7±0.05	1.75±0.1	3.5±0.05	4.0±0.1	4.0±0.1	2.0±0.05	0.25±0.02

Marking Codes

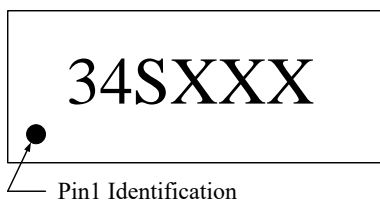

Ordering Information

Part Number	Working Voltage	Quantity Per Reel	Reel Size
TT0334SPX	3.3V	3,000	7 Inch

Note:

- (1) "34S" is part number, fixed.
- (2) "XXX" is the last 3 characters of the wafer's Lot No.

X-ON Electronics

Largest Supplier of Electrical and Electronic Components

Click to view similar products for [ESD Suppressors / TVS Diodes](#) category:

Click to view products by [Shenzhen JingYang](#) manufacturer:

Other Similar products are found below :

[60KS200C](#) [D18V0L1B2LP-7B](#) [D5V0F4U5P5-7](#) [NTE4902](#) [P4KE27CA](#) [P6KE11CA](#) [P6KE8.2A](#) [SA60CA](#) [SA64CA](#) [SMBJ12CATR](#)
[SMBJ33CATR](#) [SMBJ6.5A](#) [SMBJ8.0A](#) [ESD101-B1-02ELS](#) [E6327](#) [ESD112-B1-02EL](#) [E6327](#) [ESD7451N2T5G](#) [19180-510](#) [CPDT-5V0USP-](#)
[HF](#) [3.0SMCJ33CA-F](#) [3.0SMCJ36A-F](#) [HSPC16701B02TP](#) [JANTX1N6126A](#) [D3V3Q1B2DLP3-7](#) [D55V0M1B2WS-7](#) [SCM1293A-04SO](#)
[ESD200-B1-CSP0201](#) [E6327](#) [SM12-7](#) [CEN955](#) [W/DATA](#) [VESD12A1A-HD1-GS08](#) [CPDQC5V0-HF](#) [D1213A-01LP4-7B](#) [ESD101-B1-02EL](#)
[E6327](#) [AOZ8808DI-03](#) [5KP15A](#) [5KP48A](#) [5KP90A](#) [ESD3V3D7-TP](#) [15KPA36A-LF](#) [P4KE56CA](#) [P4KE68A](#) [P4KE91CATR](#) [P6KE120A](#)
[P6KE13CA](#) [P6KE43CA](#) [P6KE6.8CA](#) [P6KE8.2](#) [P6SMBJ20CA](#) [JANTX1N6072A](#) [SR2835ESKG](#) [SA90CA](#)