

## Features

- ❑ Transient protection for high-speed data lines
  - IEC 61000-4-2 (ESD) ±25kV (Air)
  - ±17kV (Contact)
  - IEC 61000-4-4 (EFT) 40A (5/50 ns)
  - Cable Discharge Event (CDE)
- ❑ Package optimized for high-speed lines
- ❑ Ultra-small package (1.0mm×0.6mm×0.55mm)
- ❑ Protects one data, control or power line
- ❑ Low capacitance: 2.0pF (Maximum)
- ❑ Low leakage current: 0.1μA @ V<sub>RWM</sub> (Typical)
- ❑ Low clamping voltage
- ❑ Each I/O pin can withstand over 1000 ESD strikes for ±8kV contact discharge

## Description

TT0501VBX is a low-capacitance Transient Voltage Suppressor (TVS) designed to provide electrostatic discharge (ESD) protection for high-speed data interfaces. With typical capacitance of 1.0pF only, TT0501VBX is designed to protect parasitic-sensitive systems against over-voltage and over-current transient events. It complies with IEC 61000-4-2 (ESD), Level 4 (±15kV air, ±8kV contact discharge), IEC 61000-4-4 (electrical fast transient - EFT) (40A, 5/50 ns), very fast charged device model (CDM) ESD and cable discharge event (CDE), etc.

TT0501VBX uses ultra-small DFN1006-2L package. Each TT0501VBX device can protect one high-speed

data line. It offers system designers flexibility to protect single data line where space is a premium concern. The combined features of low capacitance, ultra-small size and high ESD robustness make TT0501VB ideal for high-speed data port and high-frequency line (e.g., USB 2.0 & antenna line) applications, such as cellular phones and HD visual devices.

## Applications

- ❑ Serial ATA
- ❑ PCI Express
- ❑ Desktops, Servers and Notebooks
- ❑ Cellular Phones
- ❑ MDDI Ports
- ❑ USB2.0 Power and Data Line Protection
- ❑ Display Ports
- ❑ Digital Visual Interfaces (DVI)

## Mechanical Characteristics

- ❑ DFN1006-2L package
- ❑ Flammability Rating: UL 94V-0
- ❑ Marking: Part number
- ❑ Packaging: Tape and Reel

## Circuit Diagram

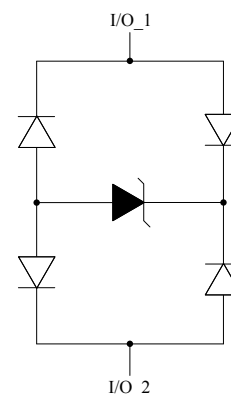

## Pin Configuration

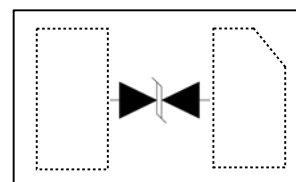

DFN1006-2L  
(Top View)

## Absolute Maximum Rating

Symbol	Parameter	Value	Units
$V_{ESD}$	ESD per IEC 61000-4-2 (Air)	±25	kV
	ESD per IEC 61000-4-2 (Contact)	±17	
$T_{OPT}$	Operating Temperature	-55/+125	°C
$T_{STG}$	Storage Temperature	-55/+150	°C

## Electrical Characteristics (T = 25°C)

Symbol	Parameter
$V_{RWM}$	Nominal Reverse Working Voltage
$I_R$	Reverse Leakage Current @ $V_{RWM}$
$V_{BR}$	Reverse Breakdown Voltage @ $I_T$
$I_T$	Test Current for Reverse Breakdown
$V_C$	Clamping Voltage @ $I_{PP}$
$I_{PP}$	Maximum Peak Pulse Current
$C_{ESD}$	Parasitic Capacitance
$V_R$	Reverse Voltage
f	Small Signal Frequency

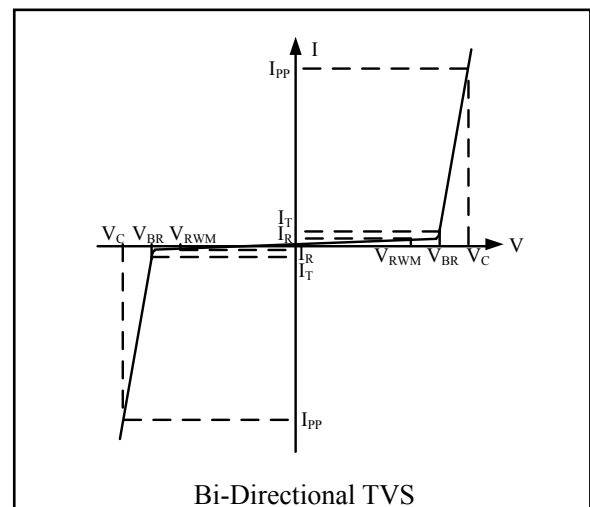

Symbol	Test Condition	Minimum	Typical	Maximum	Units
$V_{RWM}$				5.0	V
$I_R$	$V_{RWM} = 5V, T = 25^\circ C$ Between I/O and I/O		0.1	1.0	μA
$V_{BR}$	$I_T = 1mA$ Between I/O and I/O	6.0	8.0	9.0	V
$V_C$	$I_{PP} = 1A, t_p = 8/20\mu s$ Between I/O and I/O			12	V
$C_{ESD}$	$V_R = 0V, f = 1MHz$ Between I/O and I/O		1.0	2.0	pF

**Voltage Sweeping of I/O to I/O**

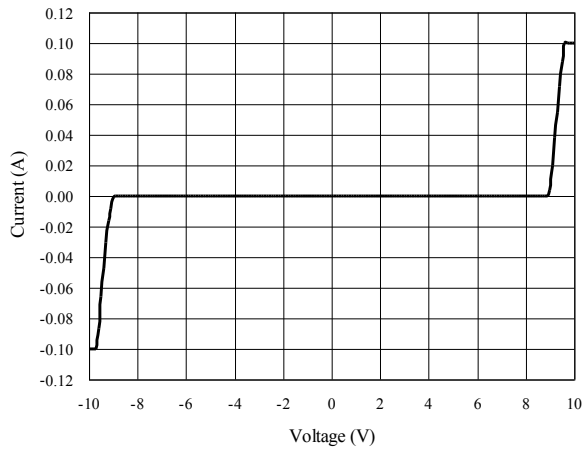

**Insertion Loss S21 of I/O to I/O**

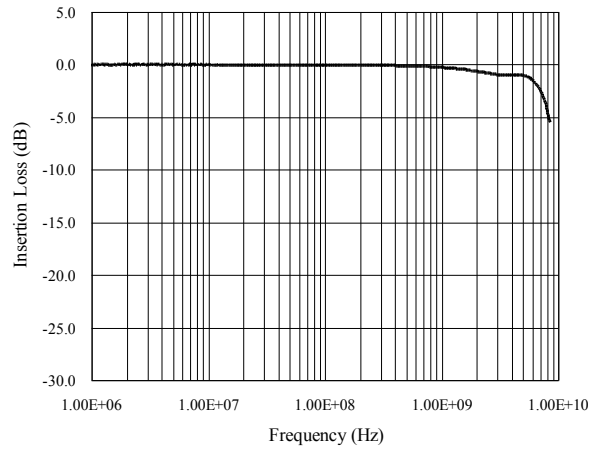

**Capacitance vs. Voltage of I/O to I/O (f = 1MHz)**

Capacitance vs. Reverse Voltage

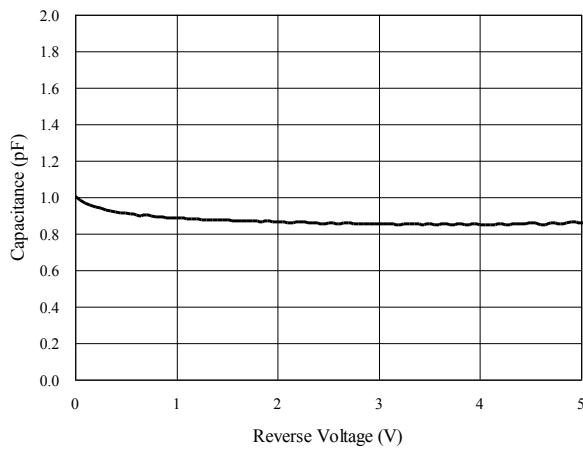

Normalized Capacitance vs. Reverse Voltage

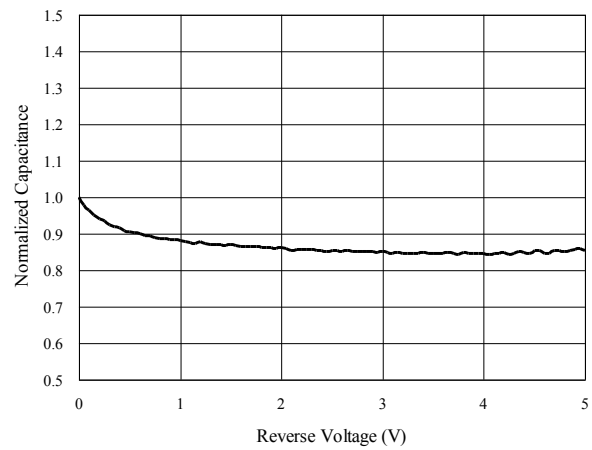

**ESD Clamping of I/O to I/O  
(+8kV Contact per IEC 61000-4-2)**

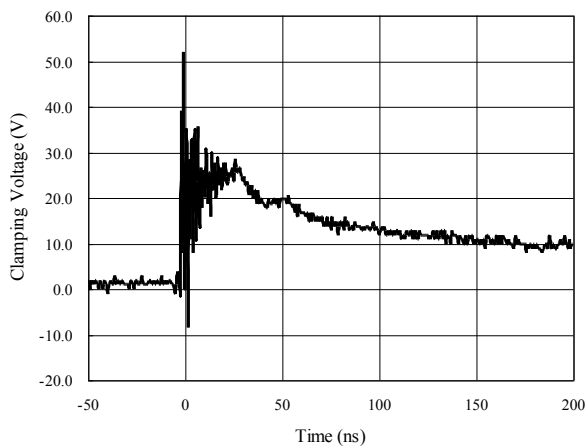

**ESD Clamping of I/O to I/O  
(-8kV Contact per IEC 61000-4-2)**

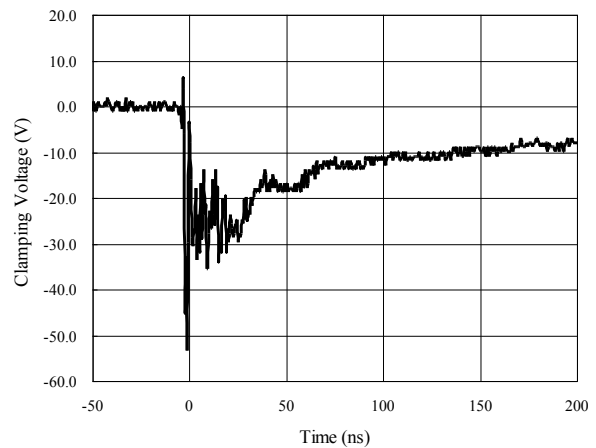

## Package Outline

- ❑ DFN1006-2L package
- ❑ 2 leads, very small package
- ❑ MSL-1

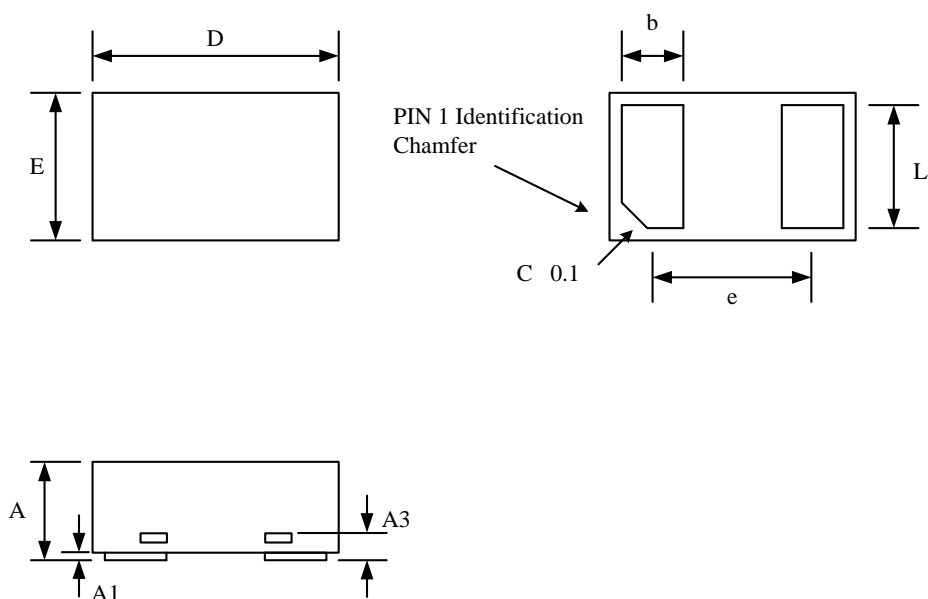

Package Dimensions (Controlling dimensions are in millimeters)

Symbol	Dimensions In Millimeters		Dimensions In Inches	
	Minimum	Maximum	Minimum	Maximum
A	0.400	0.550	0.016	0.022
A1	0.000	0.050	0.000	0.002
A3	0.125 REF		0.005 REF	
D	0.950	1.050	0.037	0.041
E	0.550	0.650	0.022	0.026
b	0.200	0.300	0.008	0.012
e	0.650 BSC		0.026 BSC	
L	0.450	0.550	0.018	0.022

### Tape and Reel Specification

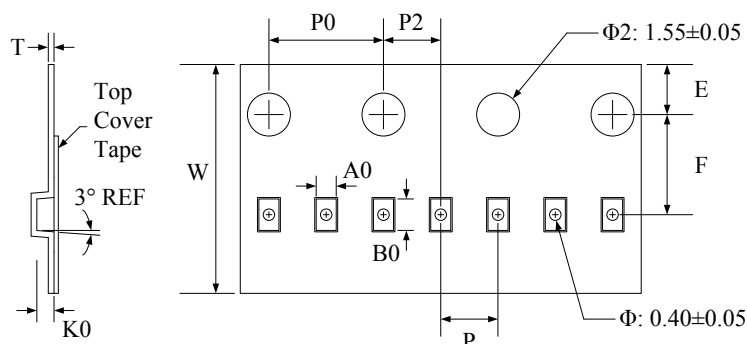

Symbol	W	A0	B0	K0	E	F	P	P0	P2	T
Dimensions (mm)	8.00±0.1	0.7±0.05	1.15±0.05	0.55±0.05	1.75±0.1	3.5±0.05	2.0±0.1	4.0±0.1	2.0±0.05	0.2±0.05

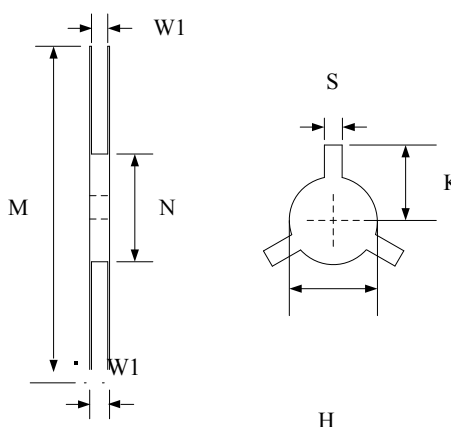
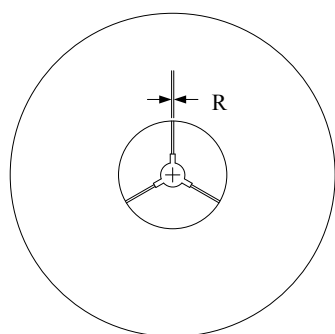

Symbol	Reel Size	M	N	W	W	H	S	K	R
Dimensions (mm)	Φ178	178.0±1.0	60.0±1.0	11.5±0.5	9.0±0.5	13.0±0.5	2.0±0.1	11.0±0.2	1.0±0.05

### Marking Codes



Note:

- (1) "W" is part number, fixed
- (2) "X" is date code, which is the assembly month in three years, changing as (1~9, 0, A~Z)

### Ordering Information

Part Number	Working Voltage	Quantity Per Reel	Reel Size
TT0501VBX	5V	10,000	7 Inch

## X-ON Electronics

Largest Supplier of Electrical and Electronic Components

*Click to view similar products for [ESD Suppressors / TVS Diodes](#) category:*

*Click to view products by [Shenzhen JingYang](#) manufacturer:*

Other Similar products are found below :

[60KS200C](#) [D18V0L1B2LP-7B](#) [D5V0F4U5P5-7](#) [NTE4902](#) [P4KE27CA](#) [P6KE11CA](#) [P6KE8.2A](#) [SA60CA](#) [SA64CA](#) [SMBJ12CATR](#)  
[SMBJ33CATR](#) [SMBJ6.5A](#) [SMBJ8.0A](#) [ESD101-B1-02ELS](#) [E6327](#) [ESD112-B1-02EL](#) [E6327](#) [ESD7451N2T5G](#) [19180-510](#) [CPDT-5V0USP-](#)  
[HF](#) [3.0SMCJ33CA-F](#) [3.0SMCJ36A-F](#) [HSPC16701B02TP](#) [JANTX1N6126A](#) [D3V3Q1B2DLP3-7](#) [D55V0M1B2WS-7](#) [SCM1293A-04SO](#)  
[ESD200-B1-CSP0201](#) [E6327](#) [SM12-7](#) [CEN955](#) [W/DATA](#) [VESD12A1A-HD1-GS08](#) [CPDQC5V0-HF](#) [D1213A-01LP4-7B](#) [ESD101-B1-02EL](#)  
[E6327](#) [AOZ8808DI-03](#) [5KP15A](#) [5KP48A](#) [5KP90A](#) [ESD3V3D7-TP](#) [15KPA36A-LF](#) [P4KE56CA](#) [P4KE68A](#) [P4KE91CATR](#) [P6KE120A](#)  
[P6KE13CA](#) [P6KE43CA](#) [P6KE6.8CA](#) [P6KE8.2](#) [P6SMBJ20CA](#) [JANTX1N6072A](#) [SR2835ESKG](#) [SA90CA](#)