



南京时恒电子科技有限公司

规格承认书

APPROVAL SHEET

客户名称:

CUSTOMER _____

产品名称:

PART NAME 片式NTC热敏电阻规格书

产品规格:

PART NUMBER CMFX 503F3950

日期:

DATE 2021年08月21日

确 认

CONFIRM

客户	供货商/制造商
品保部: _____	规格书制作: <u>鞠晓丽</u>
制造部: _____	业务员审核: _____
工程部: _____	技术部审核: <u>程鹏</u>
	品质部审核: <u>李昕媛</u>

南京时恒电子科技有限公司

地址: 南京市江宁区湖熟镇金阳路18号 邮编: 211121

TEL: 025-52121868

FAX: 025-52122373



Http:// www.shiheng.com.cn

[E-MAILsales@shiheng.com.cn](mailto:sales@shiheng.com.cn)

CMFXX503F3950FB	50±1%	3950±1%	4010	0.13	1.0	<3	100	-40~+125
-----------------	-------	---------	------	------	-----	----	-----	----------

4 检验和测试程序

测试条件

如无特别规定，检验和测试的标准大气环境条件如下：

- 环境温度：20±15℃；
- 相对湿度：65±20%；
- 气压：86 kPa~106 kPa

如果对测试结果有异议，则在下述条件下测试：

- 环境温度：25±2℃；
- 相对湿度：65±5%
- 气压：86kPa ~ 106kPa

检查设备

外观检查：20 倍放大镜；

阻值检查：热敏电阻测试仪

4 Test and Measurement Procedures

Test Conditions

Unless otherwise specified, the standard atmospheric conditions for measurement/test as:

- Ambient Temperature: 20±15℃
- Relative Humidity: 65±20%
- Air Pressure: 86kPa to 106kPa

If any doubt on the results, measurements/tests should be made within the following limits:

- Ambient Temperature: 25±2℃
- Relative Humidity: 65±5%
- Air Pressure: 86kPa to 106kPa

Inspection Equipment

Visual Examination: 20× magnifier

Resistance value test: Thermistor resistance tester

5 电性测试 Electrical Test

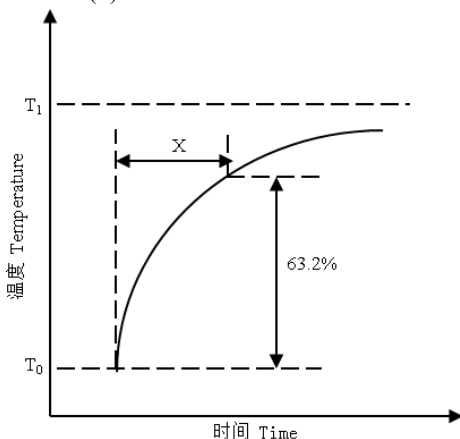
序号 No.	项目 Items	测试方法及备注 Test Methods and Remarks
1	25℃零功率电阻值 Nominal Zero-Power Resistance at 25℃(R25)	环境温度Ambient temperature: 25±0.05℃ 测试功率Measuring electric power: ≤0.1mW
2	B 值常数 Nominal B Constant	分别在环境温度 25±0.05℃, 50±0.05℃或 85±0.05℃下测量电阻值。 Measure the resistance at the ambient temperature of 25±0.05℃, 50±0.05℃ or 85±0.05℃. $B(25-50^{\circ}\text{C}) = \frac{\ln R_{25} - \ln R_{50}}{1/T_{25} - 1/T_{50}} \quad B(25-85^{\circ}\text{C}) = \frac{\ln R_{25} - \ln R_{85}}{1/T_{25} - 1/T_{85}}$ T: 绝对温度 (K) Absolute temperature (K)
3	热时间常数 Thermal Time Constant	<p>在零功率条件下，当热敏电阻的环境温度发生急剧变化时，热敏电阻元件产生最初温度 T₀ 与最终温度 T₁ 两者温度差的 63.2% 的温度变化所需要的时间，通常以秒(S)表示。</p> <p>The total time for the temperature of the thermistor to change by 63.2% of the difference from ambient temperature T₀ (°C) to T₁ (°C) by the drastic change of the power applied to thermistor from Non-zero Power to Zero-Power state, normally expressed in second(S).</p> 

4	耗散系数 Dissipation Factor	在一定环境温度下，NTC 热敏电阻通过自身发热使其温度升高 1℃ 时所需要的功率，通常以 mW/℃ 表示。可由下面公式计算： The required power which makes the NTC thermistor body temperature raise 1℃ through self-heated, normally expressed in milliwatts per degree Celsius (mW/℃). It can be calculated by the following formula: $\delta = \frac{W}{T-T_0}$
5	额定功率 Rated Power	在环境温度 25℃ 下因自身发热使表面温度升高 100℃ 所需要的功率。 The necessary electric power makes thermistor's temperature rise 100℃ by self-heating at ambient temperature 25℃.
6	允许工作电流 Permissible operating current	在静止空气中通过自身发热使其升温为 1℃ 的电流。 The current that keep body temperature of chip NTC on the PC board in still air rising 1℃ by self-heating.

6 信赖性试验 Reliability Test

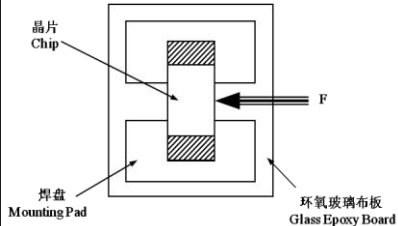
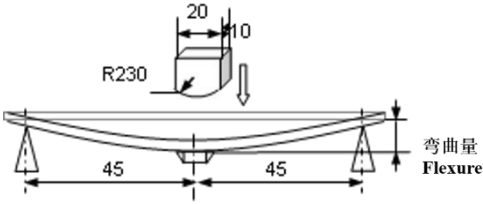
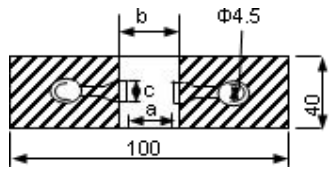
项目 Items	测试标准 Standard	测试方法及备注 Test Methods and Remarks	要求 Requirements																														
端头附着力 Terminal Strength	IEC 60068-2-21	<p>将晶片焊接在测试基板上（如右图所示的环氧玻璃布板），按箭头所示方向施加作用力； Solder the chip to the testing jig (glass epoxy board shown in the right) using eutectic solder. Then apply a force in the direction of the arrow.</p> <table border="1"> <thead> <tr> <th>尺寸 Size</th> <th>F</th> <th>保持时间 Duration</th> </tr> </thead> <tbody> <tr> <td>0201</td> <td>2N</td> <td rowspan="3">10±1s</td> </tr> <tr> <td>X, A</td> <td>5N</td> </tr> <tr> <td>B</td> <td>10N</td> </tr> </tbody> </table>	尺寸 Size	F	保持时间 Duration	0201	2N	10±1s	X, A	5N	B	10N	<p>端电极无脱落且瓷体无损伤。 No removal or split of the termination or other defects shall occur.</p> 																				
尺寸 Size	F	保持时间 Duration																															
0201	2N	10±1s																															
X, A	5N																																
B	10N																																
抗弯强度 Resistance to Flexure	IEC 60068-2-21	<p>将晶片焊接在测试基板上（如右图所示的环氧玻璃布板），按下图箭头所示方向施加作用力； Solder the chip to the test jig (glass epoxy board shown in the right) using a eutectic solder. Then apply a force in the direction shown as follow;</p>  <table border="1"> <thead> <tr> <th>尺寸 Size</th> <th>弯曲变形量 Flexure</th> <th>施压速度 Pressurizing Speed</th> <th>保持时间 Duration</th> </tr> </thead> <tbody> <tr> <td>0201,</td> <td>1mm</td> <td rowspan="2"><0.5mm/s</td> <td rowspan="2">10±1s</td> </tr> <tr> <td>X, A, B</td> <td>2mm</td> </tr> </tbody> </table>	尺寸 Size	弯曲变形量 Flexure	施压速度 Pressurizing Speed	保持时间 Duration	0201,	1mm	<0.5mm/s	10±1s	X, A, B	2mm	<p>① 无外观损伤。 No visible damage. ② $\Delta R_{25}/R_{25} \leq 2\%$</p> <p>单位 unit: mm</p> <table border="1"> <thead> <tr> <th>类型 Type</th> <th>a</th> <th>b</th> <th>c</th> </tr> </thead> <tbody> <tr> <td>0201</td> <td>0.25</td> <td>0.3</td> <td>0.3</td> </tr> <tr> <td>X</td> <td>0.4</td> <td>1.5</td> <td>0.5</td> </tr> <tr> <td>A</td> <td>1.0</td> <td>3.0</td> <td>1.2</td> </tr> <tr> <td>B</td> <td>1.2</td> <td>4.0</td> <td>1.65</td> </tr> </tbody> </table> 	类型 Type	a	b	c	0201	0.25	0.3	0.3	X	0.4	1.5	0.5	A	1.0	3.0	1.2	B	1.2	4.0	1.65
尺寸 Size	弯曲变形量 Flexure	施压速度 Pressurizing Speed	保持时间 Duration																														
0201,	1mm	<0.5mm/s	10±1s																														
X, A, B	2mm																																
类型 Type	a	b	c																														
0201	0.25	0.3	0.3																														
X	0.4	1.5	0.5																														
A	1.0	3.0	1.2																														
B	1.2	4.0	1.65																														

<p>振动 Vibration</p>	<p>IEC 60068-2-80</p>	<p>① 将晶片焊接在测试基板上（如右图所示的环氧玻璃布板）； Solder the chip to the testing jig (glass epoxy board shown in the left) using eutectic solder.</p> <p>② 晶片以全振幅为 1.5mm 进行振动，频率范围为 10Hz ~55 Hz； The chip shall be subjected to a simple harmonic motion having total amplitude of 1.5mm, the frequency being varied uniformly between the approximate limits of 10 and 55 Hz.</p> <p>③ 振动频率按 10Hz→55Hz→10Hz 循环，周期为 1 分钟，在空间三个互相垂直的方向上各振动 2 小时（共 6 小时）。 The frequency ranges from 10 to 55 Hz and return to 10 Hz shall be traversed in approximately 1 minute. This motion shall be applied for a period of 2 hours in each 3 mutually perpendicular directions (total of 6 hours).</p>	<p>无外观损伤。 No visible damage.</p> 															
<p>坠落 Dropping</p>	<p>IEC 60068-2-32</p>	<p>从 1m 的高度让晶片自由坠落至水泥地面 10 次。 Drop a chip 10 times on a concrete floor from a height of 1 meter.</p>	<p>无外观损伤。 No visible damage.</p>															
<p>可焊性 Solderability</p>	<p>IEC 60068-2-58</p>	<p>① 焊接温度 Solder temperature: 245±5 °C. ② 浸渍时间 Duration: 3±0.3s. ③ 焊锡成分 Solder: 96.5Sn/3.0Ag/0.5Cu. ④ 助焊剂 Flux: (重量比) 25%松香和 75%酒精 25% Resin and 75% ethanol in weight.</p>	<p>① 无外观损伤； No visible damage. ② 元件端电极的焊锡覆盖率不小于 95%。 Wetting shall exceed 95% coverage.</p>															
<p>耐焊性 Resistance to Soldering Heat</p>	<p>IEC 60068-2-58</p>	<p>① 焊接温度 Solder temperature: 260±5 °C. ② 浸渍时间 Duration: 10±1s. ③ 焊锡成分 Solder: 96.5Sn/3.0Ag/0.5Cu. ④ 助焊剂 Flux: (重量比) 25%松香和 75%酒精 25% Resin and 75% ethanol in weight. ⑤ 试验后标准条件下放置 1~2 小时后测量。 The chip shall be stabilized at normal condition for 1~2 hours before measuring.</p>	<p>① 无外观损伤； No visible damage. ② $\Delta R_{25}/R_{25} \leq 2\%$ ③ $\Delta B/B \leq 1\%$</p>															
<p>温度周期 Temperature cycling</p>	<p>IEC 60068-2-14</p>	<p>① 无负载于下表所示的环境条件下重复 5 次。 5 cycles of following sequence without loading.</p> <table border="1" data-bbox="491 1429 1040 1621"> <thead> <tr> <th>步骤 Step</th> <th>温度 Temperature</th> <th>时间 Time</th> </tr> </thead> <tbody> <tr> <td>1</td> <td>-40±5 °C</td> <td>30±3min</td> </tr> <tr> <td>2</td> <td>25±2 °C</td> <td>5±3min</td> </tr> <tr> <td>3</td> <td>125±2 °C</td> <td>30±3min</td> </tr> <tr> <td>4</td> <td>25±2 °C</td> <td>5±3min</td> </tr> </tbody> </table> <p>② 试验后标准条件下放置 1~2 小时后测量。 The chip shall be stabilized at normal condition for 1~2 hours before measuring.</p>	步骤 Step	温度 Temperature	时间 Time	1	-40±5 °C	30±3min	2	25±2 °C	5±3min	3	125±2 °C	30±3min	4	25±2 °C	5±3min	<p>① 无外观损伤； No visible damage. ② $\Delta R_{25}/R_{25} \leq 2\%$ ③ $\Delta B/B \leq 1\%$</p>
步骤 Step	温度 Temperature	时间 Time																
1	-40±5 °C	30±3min																
2	25±2 °C	5±3min																
3	125±2 °C	30±3min																
4	25±2 °C	5±3min																
<p>高温存放 Resistance to dry heat</p>	<p>IEC 60068-2-2</p>	<p>① 在 125±5 °C 空气中，无负载放置 1000±24 小时。 125±5 °C in air, for 1000±24 hours without loading. ② 试验后标准条件下放置 1~2 小时后测量。 The chip shall be stabilized at normal condition for 1~2 hours before measuring.</p>	<p>① 无外观损伤； No visible damage. ② $\Delta R_{25}/R_{25} \leq 2\%$ ③ $\Delta B/B \leq 1\%$</p>															

低温存放 Resistance to cold	IEC 60068-2-1	① 在 -40 ± 3 °C空气中, 无负载放置 1000 ± 24 小时。 -40 ± 3 °C in air, for 1000 ± 24 hours without loading. ② 试验后标准条件下放置 1~2 小时后测量。 The chip shall be stabilized at normal condition for 1~2 hours before measuring.	① 无外观损伤; No visible damage. ② $ \Delta R25/R25 \leq 2\%$ ③ $ \Delta B/B \leq 1\%$
湿热存放 Resistance to damp heat	IEC 60068-2-78	① 在 40 ± 2 °C, 相对湿度 90~95%空气中, 无负载放置 1000 ± 24 小时。 40 ± 2 °C, 90~95%RH in air, for 1000 ± 24 hours without loading. ② 试验后标准条件下放置 1~2 小时后测量。 The chip shall be stabilized at normal condition for 1~2 hours before measuring.	① 无外观损伤; No visible damage. ② $ \Delta R25/R25 \leq 2\%$ ③ $ \Delta B/B \leq 1\%$
高温负荷 Resistance to high temperature load	IEC 60539-1 5.25.4	① 在 85 ± 2 °C空气中, 施加允许工作电流 1000 ± 48 小时。 85 ± 2 °C in air with permissive operating current for 1000 ± 48 hours ② 试验后标准条件下放置 1~2 小时后测量。 The chip shall be stabilized at normal condition for 1~2 hours before measuring.	① 无外观损伤; No visible damage. ② $ \Delta R25/R25 \leq 2\%$ ③ $ \Delta B/B \leq 1\%$

7 编带 Taping

类型 Type	0201	X	A	B
编带厚度 Tape thickness(mm)	0.5 ± 0.15	0.5 ± 0.15	0.8 ± 0.15	0.85 ± 0.2
编带材质 Tape material	纸带 Paper Tape			
每盘数量 Quantity per Reel	15K	10K	4K	4K

(1) 编带图 Taping Drawings

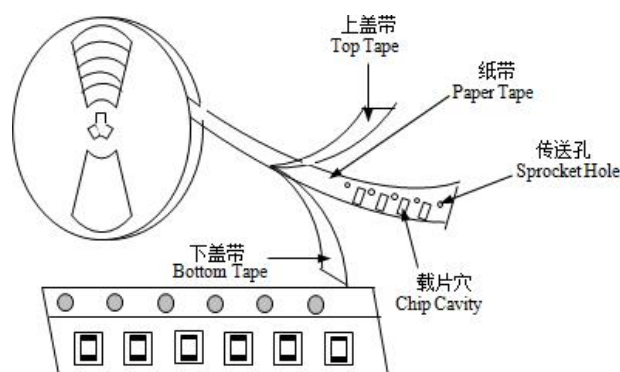

(2) 纸带尺寸 Paper Tape Dimensions (单位 Unit: mm)

CMF0201 系列 CMF0201 series

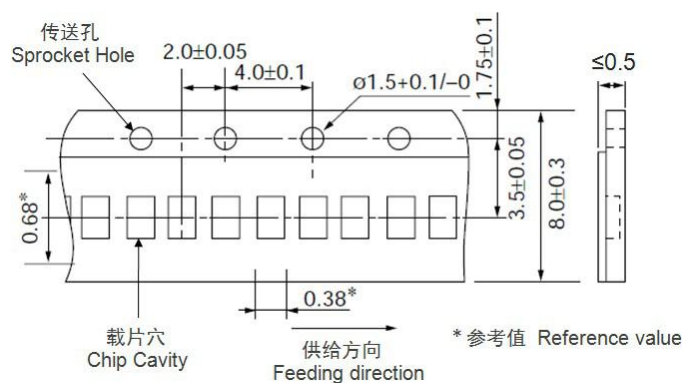

CMFX 系列 CMFX series

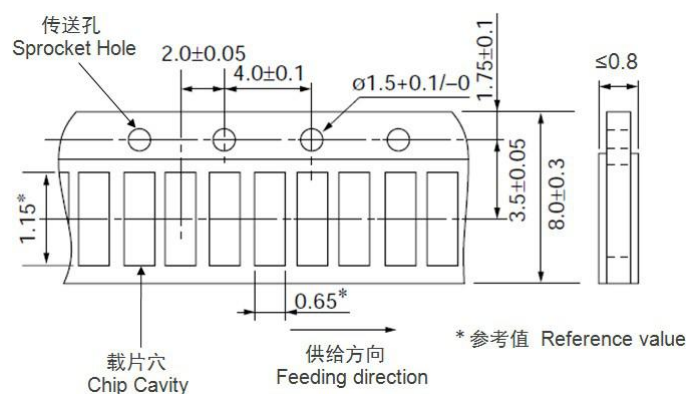

CMFA 系列 CMFA series

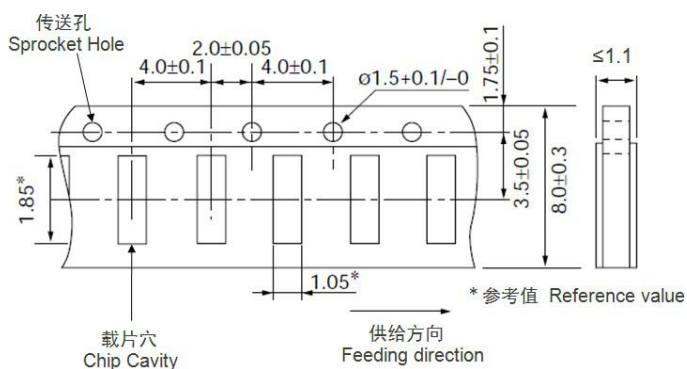

CMFB 系列 CMFB series

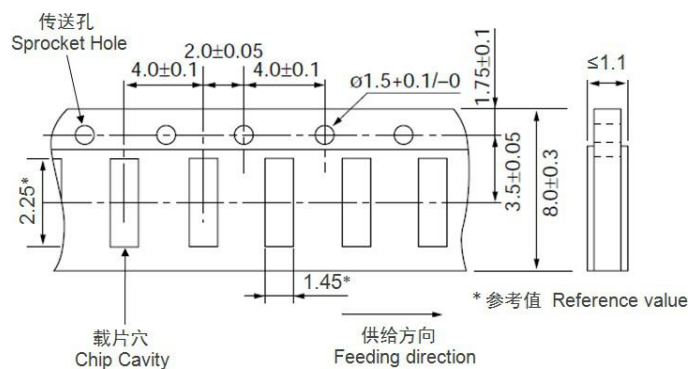

(3) 卷盘尺寸 Reel Dimensions (单位 Unit: mm)

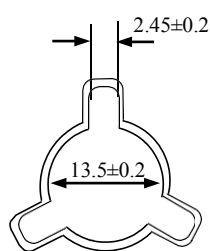
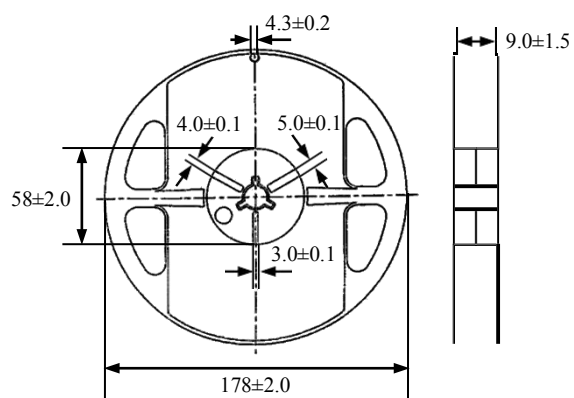

8 储存

- **储存条件**

- a. 储存温度: $-10^{\circ}\text{C} \sim 40^{\circ}\text{C}$
- b. 相对湿度: $\leq 75\% \text{RH}$
- c. 避免接触粉尘、腐蚀性气氛和阳光

- **储存期限: 产品交付后 6 个月**

9 注意事项

- CMF 系列热敏电阻不可在以下条件下工作或储存:

- (1) 腐蚀性气体或还原性气体
(氯气、硫化氢气体、氨气、硫酸气体、一氧化氮等)。
- (2) 挥发性或易燃性气体
- (3) 多尘条件
- (4) 高压或低压条件
- (5) 潮湿场所
- (6) 存在盐水、油、化学液体或有机溶剂的场所
- (7) 强烈振动
- (8) 存在类似有害条件的其他场所

- CMF 系列热敏电阻的陶瓷属于易碎材料, 使用时不可施加过大压力或冲击。

- CMF 系列热敏电阻不可在超过目录规定的温度范围情况下工作。

8 Storage

- **Storage Conditions**

- a. Storage Temperature: $-10^{\circ}\text{C} \sim 40^{\circ}\text{C}$
- b. Relative Humidity: $\leq 75\% \text{RH}$
- c. Keep away from corrosive atmosphere and sunlight.

- **Period of Storage: 6 Months after delivery**

9 Notes & Warnings

- The CMF series thermistors shall not be operated and stored under the following environmental condition:

- (1) Corrosive or deoxidized atmospheres
(such as chlorine, sulfurated hydrogen, ammonia, sulfuric acid, nitric oxide and so on)
- (2) Volatile or inflammable atmospheres
- (3) Dusty condition
- (4) Excessively high or low pressure condition
- (5) Humid site
- (6) Places with brine, oil, chemical liquid or organic solvent
- (7) Intense vibration
- (8) Places with analogously deleterious conditions

- The ceramic body of the CMF series thermistors is fragile, no excessive pressure or impact shall be exerted on it.

- The CMF series thermistors shall not be operated beyond the specified "Operating Temperature Range" in the catalog.

10 建议焊接条件

• 回流焊

温升 1~2°C/sec.

预热: 150~170°C/90±30 sec.

大于 240°C时间: 20~40sec

峰值温度: 最高 260°C/10 sec.

焊锡: 96.5Sn/3.0Ag/0.5Cu

回流焊: 最多 2 次

10 Recommended Soldering Technologies

• Re-flowing Profile

1~2°C/sec. Ramp

Pre-heating: 150~170°C/90±30 sec.

Time above 240°C: 20~40 sec.

Peak temperature: 260°C Max./10 sec.

Solder paste: 96.5Sn/3.0Ag/0.5Cu

Max.2 times for re-flowing

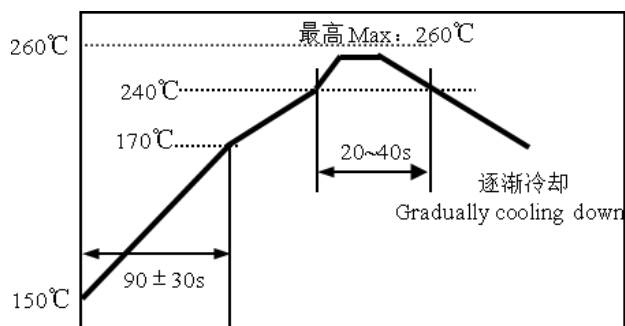

• 手工焊

烙铁功率: 最大 20W

预热: 150°C/60sec.

烙铁头温度: 最高 280°C

焊接时间: 最多 3sec.

焊锡: 96.5Sn/3.0Ag/0.5Cu

手工焊: 最多 1 次

• Iron Soldering Profile

Iron soldering power: Max.20W

Pre-heating: 150°C/60sec.

Soldering Tip temperature: 280°C Max.

Soldering time: 3 sec Max.

Solder paste: 96.5Sn/3.0Ag/0.5Cu

Max.1 times for iron soldering

[注: 不要使烙铁头接触到端头]

[Note: Take care not to apply the tip of the soldering iron to the terminal electrodes.]

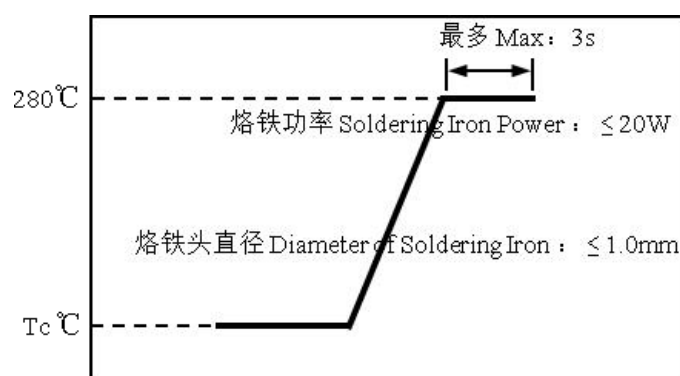

11 R-T 表 R-T table

CMFXX503F3950FB

温度 Temp. (°C)	R 最小值 R_Min (Kohm)	R 中心值 R_Cent (Kohm)	R 最大值 R_Max (Kohm)	阻值公差 Res TOL.	温度公差 Temp. TOL.(°C)
-40	1,542.135	1,612.772	1,686.477	4.57%	0.67
-39	1,446.393	1,511.666	1,579.727	4.50%	0.66
-38	1,357.159	1,417.493	1,480.362	4.44%	0.66
-37	1,273.956	1,329.741	1,387.831	4.37%	0.65
-36	1,196.343	1,247.937	1,301.626	4.30%	0.65
-35	1,123.913	1,171.644	1,221.280	4.24%	0.64
-34	1,056.293	1,100.462	1,146.364	4.17%	0.64
-33	993.136	1,034.020	1,076.480	4.11%	0.63
-32	934.124	971.977	1,011.264	4.04%	0.63
-31	878.962	914.018	950.377	3.98%	0.62
-30	827.379	859.852	893.510	3.91%	0.62
-29	779.122	809.210	840.375	3.85%	0.61
-28	733.959	761.843	790.708	3.79%	0.61
-27	691.675	717.523	744.262	3.73%	0.60
-26	652.072	676.037	700.812	3.66%	0.59
-25	614.964	637.188	660.149	3.60%	0.59
-24	580.182	600.795	622.079	3.54%	0.58
-23	547.566	566.689	586.422	3.48%	0.58
-22	516.971	534.715	553.013	3.42%	0.57
-21	488.260	504.727	521.698	3.36%	0.57
-20	461.308	476.593	492.335	3.30%	0.56
-19	435.997	450.186	464.791	3.24%	0.55
-18	412.219	425.393	438.945	3.19%	0.55
-17	389.872	402.106	414.683	3.13%	0.54
-16	368.864	380.226	391.899	3.07%	0.54
-15	349.106	359.660	370.495	3.01%	0.53
-14	330.518	340.322	350.381	2.96%	0.52
-13	313.025	322.132	331.472	2.90%	0.52
-12	296.556	305.017	313.689	2.84%	0.51
-11	281.045	288.908	296.960	2.79%	0.50
-10	266.433	273.739	281.217	2.73%	0.50
-9	252.662	259.452	266.397	2.68%	0.49
-8	239.680	245.989	252.439	2.62%	0.48
-7	227.437	233.301	239.291	2.57%	0.48
-6	215.888	221.337	226.901	2.51%	0.47
-5	204.989	210.053	215.220	2.46%	0.46
-4	194.700	199.406	204.206	2.41%	0.46
-3	184.985	189.358	193.816	2.35%	0.45
-2	175.808	179.872	184.011	2.30%	0.44
-1	167.137	170.913	174.757	2.25%	0.43
0	158.941	162.449	166.019	2.20%	0.43
1	151.192	154.451	157.765	2.15%	0.42

温度 Temp. (°C)	R 最小值 R_Min (Kohm)	R 中心值 R_Cent (Kohm)	R 最大值 R_Max (Kohm)	阻值公差 Res TOL.	温度公差 Temp. TOL.(°C)
2	143.863	146.891	149.967	2.09%	0.41
3	136.929	139.741	142.597	2.04%	0.41
4	130.368	132.979	135.629	1.99%	0.40
5	124.156	126.580	129.039	1.94%	0.39
6	118.274	120.524	122.805	1.89%	0.38
7	112.702	114.791	116.906	1.84%	0.38
8	107.424	109.361	111.323	1.79%	0.37
9	102.420	104.218	106.036	1.74%	0.36
10	97.677	99.343	101.028	1.70%	0.35
11	93.179	94.723	96.284	1.65%	0.34
12	88.912	90.343	91.788	1.60%	0.34
13	84.863	86.189	87.526	1.55%	0.33
14	81.021	82.247	83.484	1.50%	0.32
15	77.372	78.507	79.651	1.46%	0.31
16	73.908	74.957	76.014	1.41%	0.30
17	70.617	71.586	72.562	1.36%	0.30
18	67.490	68.385	69.286	1.32%	0.29
19	64.517	65.344	66.174	1.27%	0.28
20	61.692	62.454	63.219	1.22%	0.27
21	59.005	59.707	60.411	1.18%	0.26
22	56.449	57.095	57.742	1.13%	0.25
23	54.017	54.611	55.206	1.09%	0.25
24	51.703	52.248	52.794	1.04%	0.24
25	49.500	50.000	50.500	1.00%	0.23
26	47.361	47.860	48.360	1.04%	0.24
27	45.325	45.823	46.322	1.09%	0.25
28	43.388	43.883	44.380	1.13%	0.26
29	41.543	42.035	42.529	1.18%	0.27
30	39.786	40.275	40.766	1.22%	0.29
31	38.113	38.597	39.084	1.26%	0.30
32	36.518	36.998	37.481	1.30%	0.31
33	34.999	35.474	35.952	1.35%	0.32
34	33.550	34.020	34.492	1.39%	0.33
35	32.169	32.633	33.100	1.43%	0.35
36	30.851	31.309	31.771	1.47%	0.36
37	29.595	30.046	30.502	1.52%	0.37
38	28.395	28.841	29.290	1.56%	0.38
39	27.251	27.689	28.132	1.60%	0.40
40	26.158	26.590	27.026	1.64%	0.41
41	25.115	25.540	25.969	1.68%	0.42
42	24.119	24.536	24.959	1.72%	0.43
43	23.167	23.577	23.993	1.76%	0.45
44	22.257	22.661	23.069	1.80%	0.46
45	21.388	21.784	22.186	1.84%	0.47
46	20.557	20.946	21.340	1.88%	0.49

温度 Temp. (°C)	R 最小值 R_Min (Kohm)	R 中心值 R_Cent (Kohm)	R 最大值 R_Max (Kohm)	阻值公差 Res TOL.	温度公差 Temp. TOL.(°C)
47	19.762	20.144	20.532	1.92%	0.50
48	19.002	19.377	19.757	1.96%	0.51
49	18.276	18.643	19.016	2.00%	0.53
50	17.580	17.941	18.307	2.04%	0.54
51	16.914	17.268	17.627	2.08%	0.55
52	16.277	16.624	16.976	2.12%	0.57
53	15.667	16.007	16.352	2.16%	0.58
54	15.083	15.416	15.754	2.20%	0.59
55	14.524	14.850	15.181	2.23%	0.61
56	13.988	14.307	14.632	2.27%	0.62
57	13.474	13.787	14.105	2.31%	0.64
58	12.982	13.288	13.600	2.35%	0.65
59	12.510	12.809	13.115	2.38%	0.66
60	12.057	12.351	12.650	2.42%	0.68
61	11.623	11.911	12.203	2.46%	0.69
62	11.207	11.488	11.775	2.50%	0.71
63	10.808	11.083	11.364	2.53%	0.72
64	10.425	10.694	10.969	2.57%	0.73
65	10.057	10.320	10.589	2.61%	0.75
66	9.704	9.962	10.225	2.64%	0.76
67	9.365	9.617	9.875	2.68%	0.78
68	9.040	9.286	9.538	2.71%	0.79
69	8.727	8.968	9.215	2.75%	0.81
70	8.427	8.663	8.904	2.79%	0.82
71	8.138	8.369	8.605	2.82%	0.84
72	7.861	8.086	8.317	2.86%	0.85
73	7.594	7.815	8.041	2.89%	0.87
74	7.338	7.554	7.775	2.93%	0.88
75	7.092	7.303	7.519	2.96%	0.90
76	6.855	7.061	7.273	3.00%	0.91
77	6.627	6.828	7.035	3.03%	0.93
78	6.408	6.605	6.807	3.07%	0.95
79	6.197	6.389	6.587	3.10%	0.96
80	5.994	6.182	6.376	3.13%	0.98
81	5.798	5.982	6.172	3.17%	0.99
82	5.610	5.790	5.975	3.20%	1.01
83	5.429	5.605	5.786	3.23%	1.02
84	5.254	5.426	5.604	3.27%	1.04
85	5.086	5.254	5.428	3.30%	1.06
86	4.924	5.089	5.258	3.33%	1.07
87	4.768	4.929	5.095	3.37%	1.09
88	4.618	4.775	4.937	3.40%	1.10
89	4.473	4.627	4.785	3.43%	1.12
90	4.333	4.483	4.639	3.47%	1.14
91	4.198	4.345	4.497	3.50%	1.15

温度 Temp. (°C)	R 最小值 R_Min (Kohm)	R 中心值 R_Cent (Kohm)	R 最大值 R_Max (Kohm)	阻值公差 Res TOL.	温度公差 Temp. TOL.(°C)
92	4.068	4.212	4.361	3.53%	1.17
93	3.943	4.084	4.229	3.56%	1.19
94	3.822	3.960	4.102	3.59%	1.20
95	3.705	3.840	3.979	3.63%	1.22
96	3.593	3.724	3.861	3.66%	1.24
97	3.484	3.613	3.746	3.69%	1.25
98	3.379	3.505	3.636	3.72%	1.27
99	3.278	3.401	3.529	3.75%	1.29
100	3.180	3.301	3.426	3.78%	1.31
101	3.086	3.204	3.326	3.81%	1.32
102	2.994	3.110	3.229	3.84%	1.34
103	2.906	3.019	3.136	3.88%	1.36
104	2.821	2.932	3.046	3.91%	1.38
105	2.739	2.847	2.959	3.94%	1.39
106	2.660	2.765	2.875	3.97%	1.41
107	2.583	2.686	2.794	4.00%	1.43
108	2.509	2.610	2.715	4.03%	1.45
109	2.437	2.536	2.639	4.06%	1.46
110	2.367	2.464	2.565	4.09%	1.48
111	2.300	2.395	2.494	4.12%	1.50
112	2.235	2.328	2.425	4.15%	1.52
113	2.172	2.263	2.358	4.18%	1.54
114	2.112	2.201	2.293	4.20%	1.56
115	2.053	2.140	2.230	4.23%	1.57
116	1.996	2.081	2.170	4.26%	1.59
117	1.941	2.024	2.111	4.29%	1.61
118	1.887	1.969	2.054	4.32%	1.63
119	1.836	1.916	1.999	4.35%	1.65
120	1.786	1.864	1.946	4.38%	1.67
121	1.737	1.814	1.894	4.41%	1.69
122	1.690	1.765	1.844	4.43%	1.70
123	1.645	1.718	1.795	4.46%	1.72
124	1.601	1.673	1.748	4.49%	1.74
125	1.558	1.629	1.702	4.52%	1.76

X-ON Electronics

Largest Supplier of Electrical and Electronic Components

Click to view similar products for NTC (Negative Temperature Coefficient) Thermistors category:

Click to view products by Shiheng manufacturer:

Other Similar products are found below :

[118-253FAJ-P01](#) [121-202EAC-P01](#) [123-802EAJ-P01](#) [128-105NDP-Q02](#) [135-503LAD-J01](#) [B57250V2473F560](#) [NTCLE410E3103F](#) [199-303KAF-A02](#) [30054-4](#) [M09N038F](#) [B57423V2473H062](#) [B57471V2474H062](#) [B57620C5223J062](#) [500-52AA04-101](#) [526-31AA19-104](#) [526-31AN12-202](#) [103AT-5-1P-FT](#) [10K3A542I](#) [112-103FAG-H02](#) [112-104KAG-B01](#) [11028414-00](#) [111-182CAG-H01](#) [112-103FAF-H01](#) [112-104KBF-F01](#) [118-202CAJ-P01](#) [526-31AA79-102](#) [B57442V5103J62](#) [B57401V2103H62](#) [B57621C5472J62](#) [194303KEVA01](#)
[B57359V2224J260](#) [B57343V5103J360](#) [B57621C5472K062](#) [135-105QAF-J02](#) [B57421V2153J062](#) [B57230V2103H260](#) [B57471V2684H062](#)
[B57471V2333H062](#) [126-153YJC-B01](#) [NTCS0603E3333FHT](#) [118-802EAJ-P01](#) [121-103FAC-Q02](#) [144-101FAG-001](#) [526-31AD07-153](#) [521-53AW02-104](#) [GA10K3D232](#) [USUR1000-102G-06](#) [CL109R4120](#) [GA100K6D234](#) [USUR1000-502G-06](#)