

3-Terminal Positive Voltage Regulator

FEATURE

- Maximum output current of 200mA
- Output voltage of 5V/6V/8V/9V/10V/12V/15V
- Thermal overload protection
- Short circuit current limiting

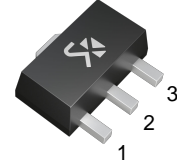

1: OUT 2: GND 3: IN
SOT-89 PLASTIC PACKAGE

ABSOLUTE MAXIMUM RATINGS (Operating temperature range applies unless otherwise specified)

Characteristic	Symbol	Value	Units
Input voltage	V_{IN}	30	V
Output Current	I_{OUT}	200	mA
Junction Temperature	T_J	+125	°C
Operating Temperature	T_{OPR}	-40~+120	°C
Storage Temperature Range	T_{STG}	-40~+150	°C

78L05A Electrical Characteristics ($T_a = 25^\circ\text{C}$) (Unless otherwise specified, $0^\circ\text{C} \leq T_J \leq 125^\circ\text{C}$, $V_I = 10\text{V}$, $I_O = 80\text{mA}$, $C_1 = 0.33\ \mu\text{F}$, $C_2 = 0.1\ \mu\text{F}$)

Characteristic	Symbol	Test conditions	MIN	TYP	MAX	Unit
Output Voltage	V_o	$T_j=25^\circ\text{C}$	4.8	5.0	5.2	V
		$7\text{V} \leq V_I \leq 20\text{V}, I_o=1\text{mA} \sim 80\text{mA}$	4.75		5.25	V
		$I_o=1\text{mA} \sim 140\text{mA}$	4.75		5.25	V (Note 1)
Load Regulation	ΔV_o	$T_j=25^\circ\text{C}, I_o=1\text{mA} \sim 200\text{mA}$		15	60	mV
		$T_j=25^\circ\text{C}, I_o=1\text{mA} \sim 80\text{mA}$		10	30	mV
Line regulation	ΔV_o	$7\text{V} \leq V_I \leq 20\text{V}, T_j=25^\circ\text{C}$		10	150	mV
		$8\text{V} \leq V_I \leq 20\text{V}, T_j=25^\circ\text{C}$		5	100	mV
Quiescent Current	I_q	$T_j=25^\circ\text{C}$		2.0	5.5	mA
Quiescent Current Change	ΔI_q	$8\text{V} \leq V_I \leq 20\text{V}$			1.5	mA
	ΔI_q	$1\text{mA} \leq V_I \leq 80\text{mA}$			0.1	mA
Output Noise Voltage	V_N	$10\text{Hz} \leq f \leq 100\text{kHz}, T_j=25^\circ\text{C}$		40		μV
Temperature coefficient of V_o	$\Delta V_o/\Delta T$	$I_o=5\text{mA}$		0.65		$\text{mV}/^\circ\text{C}$
Ripple Rejection	RR	$8\text{V} \leq V_I \leq 18\text{V}, f=120\text{Hz}, T_j=25^\circ\text{C}$	40	49		dB
Dropout Voltage	V_d			1.7		V

78L06A Electrical Characteristics ($T_a = 25^\circ\text{C}$) (Unless otherwise specified, $0^\circ\text{C} \leq T_J \leq 125^\circ\text{C}$, $V_I = 12\text{V}$, $I_O = 80\text{mA}$, $C_1 = 0.33\ \mu\text{F}$, $C_2 = 0.1\ \mu\text{F}$)

Characteristic	Symbol	Test conditions	MIN	TYP	MAX	Unit
Output Voltage	V_o	$T_j=25^\circ\text{C}$	5.75	6.0	6.25	V
		$8\text{V} \leq V_I \leq 21\text{V}, I_o=1\text{mA} \sim 80\text{mA}$	5.7		6.3	V
		$I_o=1\text{mA} \sim 140\text{mA}$	5.7		6.3	V (Note 1)
Load Regulation	ΔV_o	$T_j=25^\circ\text{C}, I_o=1\text{mA} \sim 200\text{mA}$		18	60	mV
		$T_j=25^\circ\text{C}, I_o=1\text{mA} \sim 80\text{mA}$		12	30	mV
Line regulation	ΔV_o	$8.5\text{V} \leq V_I \leq 20\text{V}, T_j=25^\circ\text{C}$		12	150	mV
		$9\text{V} \leq V_I \leq 20\text{V}, T_j=25^\circ\text{C}$		6	100	mV
Quiescent Current	I_q	$T_j=25^\circ\text{C}$		2.0	5.5	mA
Quiescent Current Change	ΔI_q	$9\text{V} \leq V_I \leq 20\text{V}$			1.5	mA
	ΔI_q	$1\text{mA} \leq V_I \leq 80\text{mA}$			0.1	mA
Output Noise Voltage	V_N	$10\text{Hz} \leq f \leq 100\text{kHz}, T_j=25^\circ\text{C}$		50		μV
Temperature coefficient of V_o	$\Delta V_o/\Delta T$	$I_o=5\text{mA}$		0.75		$\text{mV}/^\circ\text{C}$
Ripple Rejection	RR	$9\text{V} \leq V_I \leq 20\text{V}, f=120\text{Hz}, T_j=25^\circ\text{C}$	38	46		dB
Dropout Voltage	V_d			1.7		V

78L08A Electrical Characteristics ($T_a = 25^\circ\text{C}$) (Unless otherwise specified, $0^\circ\text{C} \leq T_J \leq 125^\circ\text{C}$, $V_I = 14\text{V}$, $I_O = 80\text{mA}$, $C_1 = 0.33\ \mu\text{F}$, $C_2 = 0.1\ \mu\text{F}$)

Characteristic	Symbol	Test conditions	MIN	TYP	MAX	Unit
Output Voltage	V_o	$T_j=25^\circ\text{C}$	7.7	8.0	8.3	V
		$10\text{V} \leq V_I \leq 23\text{V}, I_o=1\text{mA} \sim 80\text{mA}$	7.6		8.4	V
		$I_o=1\text{mA} \sim 140\text{mA}$	7.6		8.4	V (Note1)
Load Regulation	ΔV_o	$T_j=25^\circ\text{C}, I_o=1\text{mA} \sim 200\text{mA}$		24	80	mV
		$T_j=25^\circ\text{C}, I_o=1\text{mA} \sim 80\text{mA}$		16	40	mV
Line regulation	ΔV_o	$10.5\text{V} \leq V_I \leq 23\text{V}, T_j=25^\circ\text{C}$		16	175	mV
		$11\text{V} \leq V_I \leq 23\text{V}, T_j=25^\circ\text{C}$		8	125	mV
Quiescent Current	I_q	$T_j=25^\circ\text{C}$		2.0	5.5	mA
Quiescent Current Change	ΔI_q	$11\text{V} \leq V_I \leq 23\text{V}$			1.5	mA
	ΔI_q	$1\text{mA} \leq V_I \leq 80\text{mA}$			0.1	mA
Output Noise Voltage	V_N	$10\text{Hz} \leq f \leq 100\text{kHz}, T_j=25^\circ\text{C}$		60		μV
Temperature coefficient of V_o	$\Delta V_o/\Delta T$	$I_o=5\text{mA}$		0.8		$\text{mV}/^\circ\text{C}$
Ripple Rejection	RR	$12\text{V} \leq V_I \leq 23\text{V}, f=120\text{Hz}, T_j=25^\circ\text{C}$	36	45		dB
Dropout Voltage	V_d			1.7		V

78L09A Electrical Characteristics (T_a = 25°C) (Unless otherwise specified, 0°C ≤ T_J ≤ 125°C, V_I = 15 V, I_O = 80 mA, C₁ = 0.33 μF, C₂ = 0.1 μF)

Characteristic	Symbol	Test conditions	MIN	TYP	MAX	Unit
Output Voltage	V _O	T _J =25°C	8.64	9.0	9.36	V
		11V ≤ V _I ≤ 24V, I _O =1mA~80mA	8.55		9.45	V
		I _O =1mA~140mA	8.55		9.45	V (Note 1)
Load Regulation	ΔV _O	T _J =25°C, I _O =1mA~200mA		27	80	mV
		T _J =25°C, I _O =1mA~80mA		18	40	mV
Line regulation	ΔV _O	11.5V ≤ V _I ≤ 23V, T _J =25°C		18	225	mV
		12V ≤ V _I ≤ 23V, T _J =25°C		9	150	mV
Quiescent Current	I _q	T _J =25°C		2.0	5.5	mA
Quiescent Current Change	ΔI _q	12V ≤ V _I ≤ 23V			1.5	mA
	ΔI _q	1mA ≤ V _I ≤ 80mA			0.1	mA
Output Noise Voltage	V _N	10Hz ≤ f ≤ 100kHz, T _J =25°C		70		μV
Temperature coefficient of V _O	ΔV _O /ΔT	I _O =5mA		0.85		mV/°C
Ripple Rejection	RR	12V ≤ V _I ≤ 23V, f=120Hz, T _J =25°C	36	44		dB
Dropout Voltage	V _d			1.7		V

78L10A Electrical Characteristics (T_a = 25°C) (Unless otherwise specified, 0°C ≤ T_J ≤ 125°C, V_I = 16 V, I_O = 80 mA, C₁ = 0.33 μF, C₂ = 0.1 μF)

Characteristic	Symbol	Test conditions	MIN	TYP	MAX	Unit
Output Voltage	V _O	T _J =25°C	9.6	10.0	10.4	V
		12V ≤ V _I ≤ 25V, I _O =1mA~80mA	9.5		10.5	V
		I _O =1mA~140mA	9.5		10.5	V (Note 1)
Load Regulation	ΔV _O	T _J =25°C, I _O =1mA~200mA		30	90	mV
		T _J =25°C, I _O =1mA~80mA		20	45	mV
Line regulation	ΔV _O	12.5V ≤ V _I ≤ 23V, T _J =25°C		20	230	mV
		13V ≤ V _I ≤ 23V, T _J =25°C		10	170	mV
Quiescent Current	I _q	T _J =25°C		2.0	5.5	mA
Quiescent Current Change	ΔI _q	13V ≤ V _I ≤ 23V			1.5	mA
	ΔI _q	1mA ≤ V _I ≤ 80mA			0.1	mA
Output Noise Voltage	V _N	10Hz ≤ f ≤ 100kHz, T _J =25°C		60		μV
Temperature coefficient of V _O	ΔV _O /ΔT	I _O =5mA		0.9		mV/°C
Ripple Rejection	RR	14V ≤ V _I ≤ 23V, f=120Hz, T _J =25°C	36	45		dB
Dropout Voltage	V _d			1.7		V

78L12A Electrical Characteristics (T_a = 25°C) (Unless otherwise specified, 0°C ≤ T_J ≤ 125°C, V_I = 19 V, I_O = 80 mA, C₁ = 0.33 μF, C₂ = 0.1 μF)

Characteristic	Symbol	Test conditions	MIN	TYP	MAX	Unit
Output Voltage	V _O	T _J =25°C	11.5	12	12.6	V
		14V ≤ V _I ≤ 27V, I _O =1mA~80mA	11.4		12.6	V
		I _O =1mA~140mA	11.4		12.6	V (Note 1)
Load Regulation	ΔV _O	T _J =25°C, I _O =1mA~200mA		36	100	mV
		T _J =25°C, I _O =1mA~80mA		24	50	mV
Line regulation	ΔV _O	14.5V ≤ V _I ≤ 27V, T _J =25°C		24	250	mV
		16V ≤ V _I ≤ 27V, T _J =25°C		12	200	mV
Quiescent Current	I _q	T _J =25°C		2.0	5.5	mA
Quiescent Current Change	ΔI _q	16V ≤ V _I ≤ 27V			1.5	mA
	ΔI _q	1mA ≤ V _I ≤ 80mA			0.1	mA
Output Noise Voltage	V _N	10Hz ≤ f ≤ 100kHz, T _J =25°C		80		μV
Temperature coefficient of V _O	ΔV _O /ΔT	I _O =5mA		1.0		mV/°C
Ripple Rejection	RR	15V ≤ V _I ≤ 25V, f=120Hz, T _J =25°C	36	42		dB
Dropout Voltage	V _d			1.7		V

78L15A Electrical Characteristics (T_a = 25°C) (Unless otherwise specified, 0°C ≤ T_J ≤ 125°C, V_I = 21 V, I_O = 80 mA, C₁ = 0.33 μF, C₂ = 0.1 μF)

Characteristic	Symbol	Test conditions	MIN	TYP	MAX	Unit
Output Voltage	V _O	T _J =25°C	14.4	15	15.6	V
		17V ≤ V _I ≤ 30V, I _O =1mA~80mA	14.25		15.75	V
		I _O =1mA~140mA	14.25		15.75	V (Note 1)
Load Regulation	ΔV _O	T _J =25°C, I _O =1mA~200mA		45	150	mV
		T _J =25°C, I _O =1mA~80mA		30	75	mV
Line regulation	ΔV _O	17.5V ≤ V _I ≤ 30V, T _J =25°C		30	300	mV
		20V ≤ V _I ≤ 30V, T _J =25°C		15	250	mV
Quiescent Current	I _q	T _J =25°C		2.2	6.0	mA
Quiescent Current Change	ΔI _q	20V ≤ V _I ≤ 30V			1.5	mA
	ΔI _q	1mA ≤ V _I ≤ 80mA			0.1	mA
Output Noise Voltage	V _N	10Hz ≤ f ≤ 100kHz, T _J =25°C		90		μV
Temperature coefficient of V _O	ΔV _O /ΔT	I _O =5mA		1.3		mV/°C
Ripple Rejection	RR	18.5V ≤ V _I ≤ 28.5V, f=120Hz, T _J =25°C	33	39		dB
Dropout Voltage	V _d			1.7		V

Note 1: Power dissipation < 0.75W.

TYPICAL APPLICATION

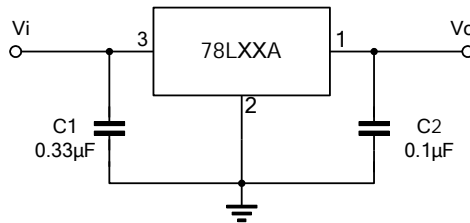

Note 1: To specify an output voltage, substitute voltage value for "XX".

Note 2: Bypass capacitors are recommended for optimum stability and transient response and should be located as close as possible to the regulators.

TYPICAL PERFORMANCE CHARACTERISTICS

Fig.1 78L33A Output Voltage vs Ambient Temperature

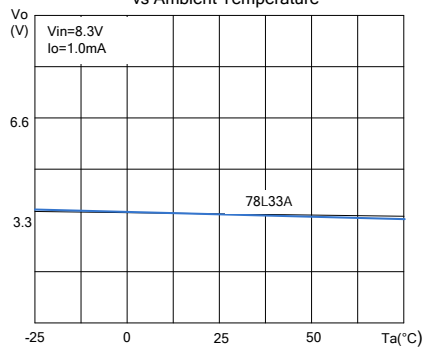

Fig.2 78L33A Quiescent Current vs Output Current

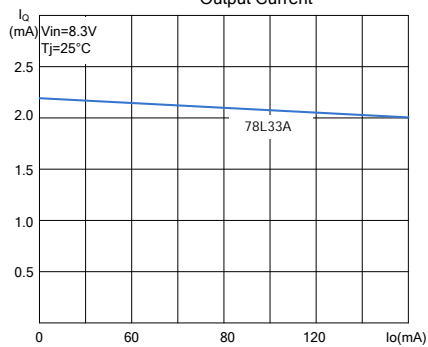

Fig.3 78L33A Quiescent Current vs Input

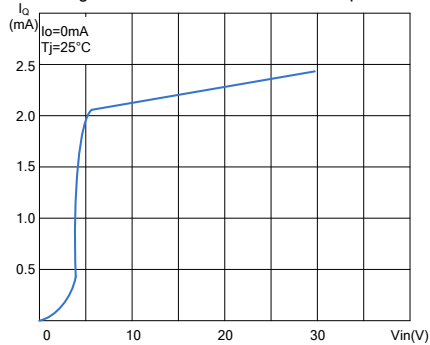

Fig.4 78L33A Thermal Shutdown

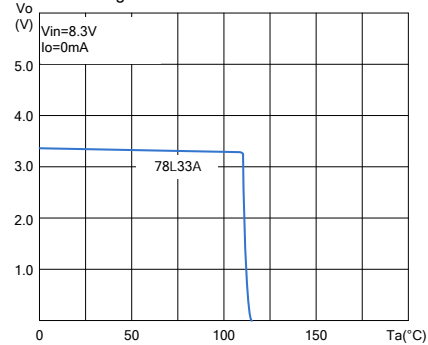

Fig.5 78L33A Output Characteristics

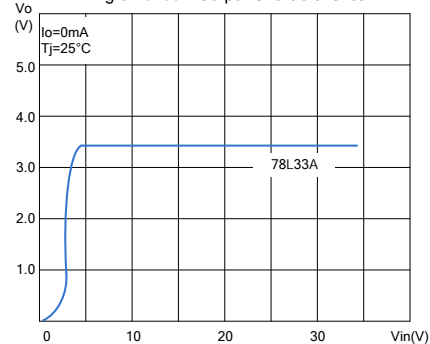
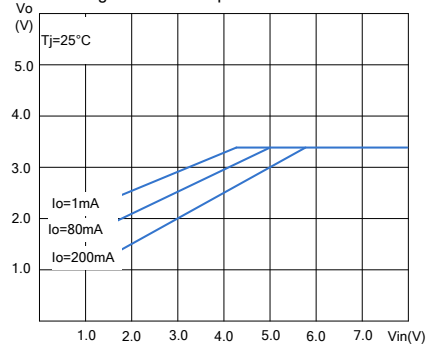
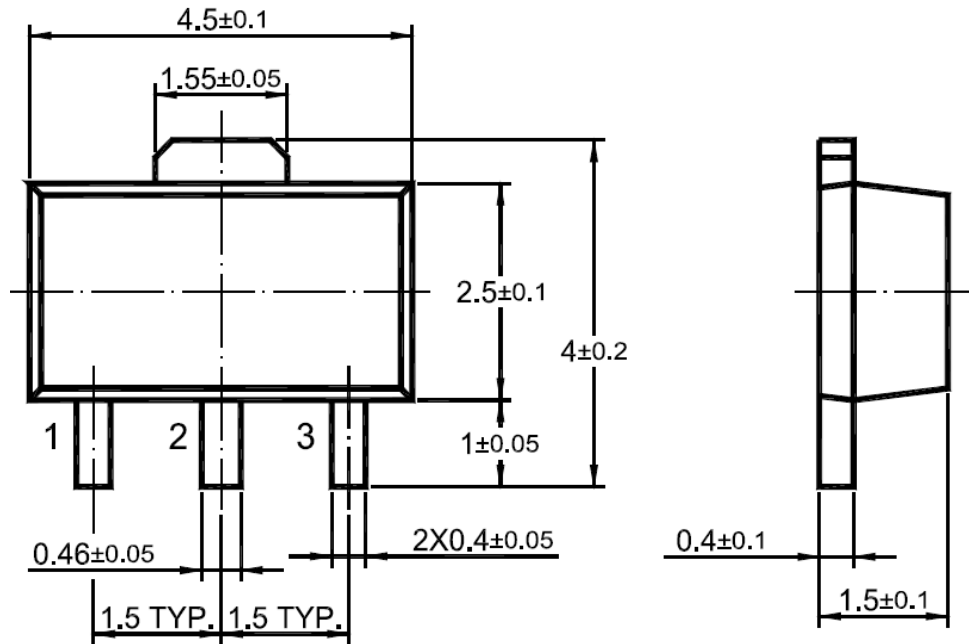

Fig.6 78L33A Dropout Characteristics



SOT-89 PACKAGE OUTLINE

Unit: mm



X-ON Electronics

Largest Supplier of Electrical and Electronic Components

Click to view similar products for [Linear Voltage Regulators](#) category:

Click to view products by [Shikues](#) manufacturer:

Other Similar products are found below :

[LV5684PVD-XH](#) [MCDTSA6-2R](#) [L7815ACV-DG](#) [714954EB](#) [ZMR500QFTA](#) [BA033LBSG2-TR](#) [LV5680P-E](#) [L79M05T-E](#) [L78LR05D-MA-E](#) [NCV317MBTG](#) [NTE7227](#) [MP2018GZD-33-P](#) [MP2018GZD-5-P](#) [LV5680NPVC-XH](#) [LT1054CN8](#) [UA78L09CLP](#) [UA78L09CLPR](#) [CAT6221-PPTD-GT3](#) [MC78M09CDTRK](#) [NCV51190MNTAG](#) [78M05](#) [HT7150-1](#) [UM1540DB-18](#) [XC6234H281VR-G](#) [WL2834CA-6/TR](#) [TPL730F33-5TR](#) [TLS850F1TA](#) [V50](#) [TPS549B22RVFR](#) [UM1540DB-33](#) [WL9200P3-50B](#) [WL9100P3-33B](#) [WL9005D4-33](#) [XC6219B152MR](#) [WL2855K33-3/TR](#) [PJ54BM33SE](#) [PJ9500M25SA](#) [MD7218E33PC1](#) [H7533-2PR](#) [SK7812AU](#) [SD1A30](#) [78L33](#) [TP78L33T3](#) [L78L33ACUTR](#) [SK6513ST3A-50](#) [SK6054D4-09](#) [SK6054D4-18](#) [SK6054D4-11](#) [SK6054D4-10](#) [LM79L12F](#) [HLP2985AIM5X-5.0](#)