

## 3-Terminal Positive Voltage Regulator

### FEATURES

- Maximum Output Current  $I_o$ : 0.1 A
- Output Voltage  $V_o$ : 5V/6V/8V/9V/10V/12V/15V
- Continuous Total Dissipation  
 $P_D$ : 0.5 W ( $T_a = 25^\circ\text{C}$ )

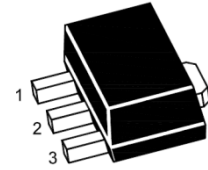

1: OUT 2: GND 3: IN  
SOT-89 PLASTIC PACKAGE

### Absolute Maximum Ratings ( $T_a = 25^\circ\text{C}$ )

Parameter		Symbol	Rating	Unit
Input Voltage	78L05K~78L08K	$V_i$	30	V
	78L09K~78L15K		35	V
Power Dissipation		$P_{tot}$	500 <sup>1)</sup>	mW
Operating Temperature		$T_{opr}$	- 20 to + 120	$^\circ\text{C}$
Storage Temperature Range		$T_{stg}$	- 55 to +150	$^\circ\text{C}$

1) 15 mm X 25 mm X 0.7 mm alumina ceramic board,  $T_a \leq 25^\circ\text{C}$

### Electrical Characteristics ( $T_a = 25^\circ\text{C}$ ) (Unless otherwise specified, $0^\circ\text{C} \leq T_J \leq 125^\circ\text{C}$ , $V_i = 10\text{ V}$ , $I_o = 40\text{ mA}$ , $C_1 = 0.33\ \mu\text{F}$ , $C_2 = 0.1\ \mu\text{F}$ )

Parameter	Symbol	Test Condition	Min.	Typ.	Max.	Unit
Output Voltage	$V_o$	$T_j = 25^\circ\text{C}$	4.8	5	5.2	V
		$7\text{ V} \leq V_i \leq 20\text{ V}$ , $1\text{ mA} \leq I_o \leq 40\text{ mA}$	4.75	--	5.25	V
		$V_i = 10\text{ V}$ , $1\text{ mA} \leq I_o \leq 70\text{ mA}$	4.75	--	5.25	V
Line Regulation	Regline	$7\text{ V} \leq V_i \leq 20\text{ V}$ , $T_j = 25^\circ\text{C}$	--	--	150	mV
		$8\text{ V} \leq V_i \leq 20\text{ V}$ , $T_j = 25^\circ\text{C}$	--	--	100	
Load Regulation	Regload	$1\text{ mA} \leq I_o \leq 100\text{ mA}$ , $T_j = 25^\circ\text{C}$	--	--	60	mV
		$1\text{ mA} \leq I_o \leq 40\text{ mA}$ , $T_j = 25^\circ\text{C}$	--	--	30	
Quiescent Current	$I_Q$	$T_j = 25^\circ\text{C}$	--	--	5.5	mA
Quiescent Current Change	$\Delta I_Q$	$8\text{ V} \leq V_i \leq 20\text{ V}$	--	--	1.5	mA
		$1\text{ mA} \leq I_o \leq 40\text{ mA}$	--	--	0.1	
Output Noise Voltage	$V_N$	$10\text{ Hz} \leq f \leq 100\text{ KHz}$ , $T_j = 25^\circ\text{C}$	--	40	--	$\mu\text{ V}$
Ripple Rejection	RR	$f = 120\text{ Hz}$ , $8\text{ V} \leq V_i \leq 18\text{ V}$ , $T_j = 25^\circ\text{C}$	41	--	--	dB
Dropout Voltage	$V_{Drop}$	$T_j = 25^\circ\text{C}$	--	1.7	--	V

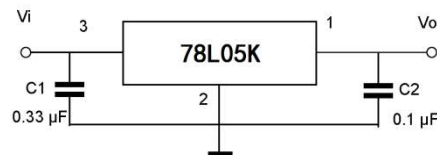

**Electrical Characteristics (T<sub>a</sub> = 25°C)** (Unless otherwise specified, 0°C ≤ T<sub>J</sub> ≤ 125°C, V<sub>I</sub> = 11 V, I<sub>O</sub> = 40 mA, C<sub>I</sub> = 0.33 μF, C<sub>2</sub> = 0.1 μF)

Parameter	Symbol	Test Condition	Min.	Typ.	Max.	Unit
Output Voltage	V <sub>O</sub>	T <sub>J</sub> = 25°C	5.76	6	6.24	V
		8.5V ≤ V <sub>I</sub> ≤ 21V, 1 mA ≤ I <sub>O</sub> ≤ 40 mA	5.7	--	6.3	V
		V <sub>I</sub> = 11 V, 1 mA ≤ I <sub>O</sub> ≤ 70 mA	5.7	--	6.3	V
Line Regulation	Regline	8.5V ≤ V <sub>I</sub> ≤ 21V, T <sub>J</sub> = 25°C	--	--	155	mV
		9 V ≤ V <sub>I</sub> ≤ 21 V, T <sub>J</sub> = 25°C	--	--	105	
Load Regulation	Regload	1 mA ≤ I <sub>O</sub> ≤ 100 mA, T <sub>J</sub> = 25°C	--	--	65	mV
		1 mA ≤ I <sub>O</sub> ≤ 40 mA, T <sub>J</sub> = 25°C	--	--	35	
Quiescent Current	I <sub>Q</sub>	T <sub>J</sub> = 25°C	--	--	5.5	mA
Quiescent Current Change	ΔI <sub>Q</sub>	9 V ≤ V <sub>I</sub> ≤ 21 V, I <sub>O</sub> = 40 mA	--	--	1.5	mA
		V <sub>I</sub> = 11 V, 1 mA ≤ I <sub>O</sub> ≤ 40 mA	--	--	0.1	
Output Noise Voltage	V <sub>N</sub>	10 Hz ≤ f ≤ 100 KHz, T <sub>J</sub> = 25°C	--	49	--	μ V
Ripple Rejection	RR	f = 120 Hz, 9 V ≤ V <sub>I</sub> ≤ 19 V, T <sub>J</sub> = 25°C	40	--	--	dB
Dropout Voltage	V <sub>Drop</sub>	T <sub>J</sub> = 25°C	--	1.7	--	V

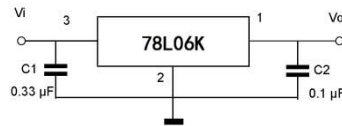

**Electrical Characteristics (T<sub>a</sub> = 25°C)** (Unless otherwise specified, 0°C ≤ T<sub>J</sub> ≤ 125°C, V<sub>I</sub> = 14 V, I<sub>O</sub> = 40 mA, C<sub>I</sub> = 0.33 μF, C<sub>2</sub> = 0.1 μF)

Parameter	Symbol	Test Condition	Min.	Typ.	Max.	Unit
Output Voltage	V <sub>O</sub>	T <sub>J</sub> = 25°C	7.7	8	8.3	V
		10.5V ≤ V <sub>I</sub> ≤ 23V, 1 mA ≤ I <sub>O</sub> ≤ 40 mA	7.6	--	8.4	V
		V <sub>I</sub> = 14 V, 1 mA ≤ I <sub>O</sub> ≤ 70 mA	7.6	--	8.4	V
Line Regulation	Regline	10.5V ≤ V <sub>I</sub> ≤ 23V, T <sub>J</sub> = 25°C	--	--	175	mV
		11 V ≤ V <sub>I</sub> ≤ 23 V, T <sub>J</sub> = 25°C	--	--	125	
Load Regulation	Regload	1 mA ≤ I <sub>O</sub> ≤ 100 mA, T <sub>J</sub> = 25°C	--	--	80	mV
		1 mA ≤ I <sub>O</sub> ≤ 40 mA, T <sub>J</sub> = 25°C	--	--	40	
Quiescent Current	I <sub>Q</sub>	T <sub>J</sub> = 25°C	--	--	5.5	mA
Quiescent Current Change	ΔI <sub>Q</sub>	12 V ≤ V <sub>I</sub> ≤ 23 V, I <sub>O</sub> = 40 mA	--	--	1.5	mA
		V <sub>I</sub> = 14 V, 1 mA ≤ I <sub>O</sub> ≤ 40 mA	--	--	0.1	
Output Noise Voltage	V <sub>N</sub>	10 Hz ≤ f ≤ 100 KHz, T <sub>J</sub> = 25°C	--	60	--	μ V
Ripple Rejection	RR	f = 120 Hz, 12 V ≤ V <sub>I</sub> ≤ 22 V, T <sub>J</sub> = 25°C	39	--	--	dB
Dropout Voltage	V <sub>Drop</sub>	T <sub>J</sub> = 25°C	--	1.7	--	V

**Electrical Characteristics (T<sub>a</sub> = 25°C)** (Unless otherwise specified, 0°C ≤ T<sub>J</sub> ≤ 125°C, V<sub>I</sub> = 15 V, I<sub>O</sub> = 40 mA, C<sub>1</sub> = 0.33 μF, C<sub>2</sub> = 0.1 μF)

Parameter	Symbol	Test Condition	Min.	Typ.	Max.	Unit
Output Voltage	V <sub>O</sub>	T <sub>J</sub> = 25°C	8.64	9	9.36	V
		11.4V ≤ V <sub>I</sub> ≤ 24V, 1 mA ≤ I <sub>O</sub> ≤ 40 mA	8.55	--	9.45	V
		V <sub>I</sub> = 15 V, 1 mA ≤ I <sub>O</sub> ≤ 70 mA	8.55	--	9.45	V
Line Regulation	Regline	11.4V ≤ V <sub>I</sub> ≤ 24V, T <sub>J</sub> = 25°C	--	--	200	mV
		12 V ≤ V <sub>I</sub> ≤ 24 V, T <sub>J</sub> = 25°C	--	--	160	
Load Regulation	Regload	1 mA ≤ I <sub>O</sub> ≤ 100 mA, T <sub>J</sub> = 25°C	--	--	90	mV
		1 mA ≤ I <sub>O</sub> ≤ 40 mA, T <sub>J</sub> = 25°C	--	--	45	
Quiescent Current	I <sub>Q</sub>	T <sub>J</sub> = 25°C	--	--	6	mA
Quiescent Current Change	ΔI <sub>Q</sub>	12 V ≤ V <sub>I</sub> ≤ 24 V, I <sub>O</sub> = 40 mA	--	--	1.5	mA
		V <sub>I</sub> = 15 V, 1 mA ≤ I <sub>O</sub> ≤ 40 mA	--	--	0.1	
Output Noise Voltage	V <sub>N</sub>	10 Hz ≤ f ≤ 100 KHz, T <sub>J</sub> = 25°C	--	70	--	μV
Ripple Rejection	RR	f = 120 Hz, 12 V ≤ V <sub>I</sub> ≤ 24 V, T <sub>J</sub> = 25°C	38	--	--	dB
Dropout Voltage	V <sub>Drop</sub>	T <sub>J</sub> = 25°C	--	1.7	--	V

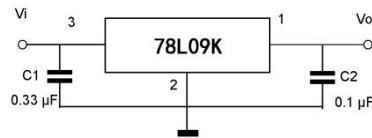

**Electrical Characteristics (T<sub>a</sub> = 25°C)** at specified virtual junction temperature, V<sub>I</sub> = 17V, I<sub>O</sub> = 40mA (unless otherwise noted)

Parameter	Test Conditions*		78L10			Units
			Min	Typ	Max	
Output voltage**		25°C	9.6	10	10.4	V
	I <sub>O</sub> = 1mA to 40 mA, V <sub>I</sub> = 13V to 25V	0°C to 125°C	9.5	10	10.5	
	I <sub>O</sub> = 1mA to 70mA,		9.5	10	10.5	
Input regulation	V <sub>I</sub> = 13V to 25V	25°C		51	175	mV
	V <sub>I</sub> = 14V to 25V			42	125	
Ripple rejection	V <sub>I</sub> = 15V to 25V, f = 120Hz	0°C to 125°C	37	44		dB
Output regulation	I <sub>O</sub> = 1mA to 100mA	25°C		20	90	mV
	I <sub>O</sub> = 1mA to 40mA			11	40	
Output noise voltage	f = 10Hz to 100 KHz	25°C		62		μV
Dropout voltage		25°C		1.7		V
Bias current		25°C		4.2	6	mA
		125°C			5.5	
Bias current change	V <sub>I</sub> = 14V to 25V	0°C to 125°C			1.5	
	I <sub>O</sub> = 1mA to 40mA				0.1	

**Electrical Characteristics ( $T_a = 25^\circ\text{C}$ )** (Unless otherwise specified,  $0^\circ\text{C} \leq T_J \leq 125^\circ\text{C}$ ,  $V_I = 19\text{ V}$ ,  $I_O = 40\text{ mA}$ ,  $C_I = 0.33\ \mu\text{F}$ ,  $C_2 = 0.1\ \mu\text{F}$ )

Parameter	Symbol	Test Condition	Min.	Typ.	Max.	Unit
Output Voltage	$V_O$	$T_J = 25^\circ\text{C}$	11.5	12	12.5	V
		$14.5\text{ V} \leq V_I \leq 27\text{ V}$ , $1\text{ mA} \leq I_O \leq 40\text{ mA}$	11.4	--	12.6	V
		$V_I = 19\text{ V}$ , $1\text{ mA} \leq I_O \leq 70\text{ mA}$	11.4	--	12.6	V
Line Regulation	Regline	$14.5\text{ V} \leq V_I \leq 27\text{ V}$ , $T_J = 25^\circ\text{C}$	--	--	250	mV
		$16\text{ V} \leq V_I \leq 27\text{ V}$ , $T_J = 25^\circ\text{C}$	--	--	200	
Load Regulation	Regload	$1\text{ mA} \leq I_O \leq 100\text{ mA}$ , $T_J = 25^\circ\text{C}$	--	--	100	mV
		$1\text{ mA} \leq I_O \leq 40\text{ mA}$ , $T_J = 25^\circ\text{C}$	--	--	50	
Quiescent Current	$I_Q$	$T_J = 25^\circ\text{C}$	--	--	6	mA
Quiescent Current Change	$\Delta I_Q$	$16\text{ V} \leq V_I \leq 27\text{ V}$	--	--	1.5	mA
		$1\text{ mA} \leq I_O \leq 40\text{ mA}$	--	--	0.1	
Output Noise Voltage	$V_N$	$10\text{ Hz} \leq f \leq 100\text{ KHz}$ , $T_J = 25^\circ\text{C}$	--	80	--	$\mu\text{ V}$
Ripple Rejection	RR	$f = 120\text{ Hz}$ , $15\text{ V} \leq V_I \leq 25\text{ V}$ , $T_J = 25^\circ\text{C}$	37	--	--	dB
Dropout Voltage	$V_{\text{Drop}}$	$T_J = 25^\circ\text{C}$	--	1.7	--	V

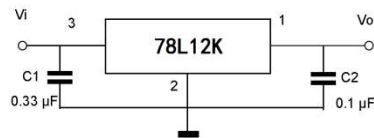

**Electrical Characteristics** (Unless otherwise specified,  $V_{IN} = 23\text{ V}$ ,  $I_{OUT} = 40\text{ mA}$ ,  $C_{IN} = 0.33\ \mu\text{F}$ ,  $C_{OUT} = 0.1\ \mu\text{F}$ ,  $T_J = 25^\circ\text{C}$ )

Parameter	Symbol	Min.	Typ.	Max.	Unit	
Output Voltage	$V_{OUT}$	14.4	15	15.6	V	
Output Voltage $17.5\text{ V} \leq V_{IN} \leq 30\text{ V}$ , $1\text{ mA} \leq I_{OUT} \leq 40\text{ mA}$	$V_{OUT}$	14.25	-	15.75	V	
Output Voltage $V_{IN} = 23\text{ V}$ , $1\text{ mA} \leq I_{OUT} \leq 70\text{ mA}$	$V_{OUT}$	14.25	-	15.75	V	
Input Regulation $17.5\text{ V} \leq V_{IN} \leq 30\text{ V}$ $19\text{ V} \leq V_{IN} \leq 30\text{ V}$	Reg. line	-	-	300	mV	
		-	-	250		
Load Regulation $1\text{ mA} \leq I_{OUT} \leq 100\text{ mA}$ $1\text{ mA} \leq I_{OUT} \leq 40\text{ mA}$	Reg. load	-	-	150	mV	
		-	-	75		
Quiescent Current	$I_Q$	-	-	6.5	mA	
Quiescent Current Change $19\text{ V} \leq V_{IN} \leq 30\text{ V}$ $1\text{ mA} \leq I_{OUT} \leq 40\text{ mA}$	$\Delta I_Q$	With line	-	-	1.5	mA
		With load	-	-	0.1	
Output Noise Voltage at $T_a = 25^\circ\text{C}$ , $10\text{ Hz} \leq f \leq 100\text{ KHz}$	$V_{NO}$	-	90	-	$\mu\text{V}$	
Ripple Rejection at $f = 120\text{ Hz}$ , $18.5\text{ V} \leq V_{IN} \leq 28.5\text{ V}$ , $T_J = 25^\circ\text{C}$	RR	34	-	-	dB	
Dropout Voltage at $T_J = 25^\circ\text{C}$	$ V_{IN} - V_{OUT} $	-	1.7	-	V	

## 78L05K Typical Characteristics

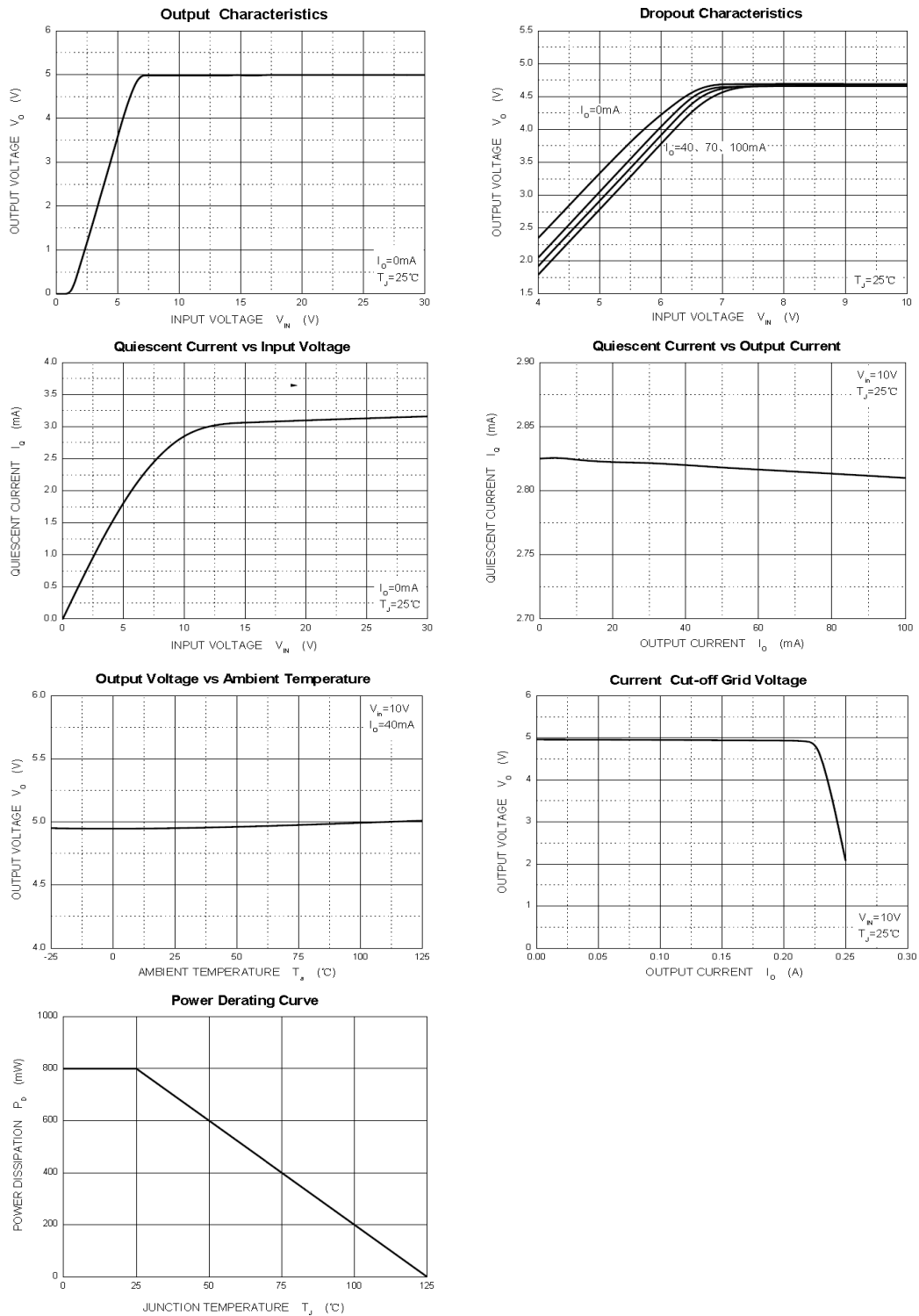

## 78L12K Typical Characteristics

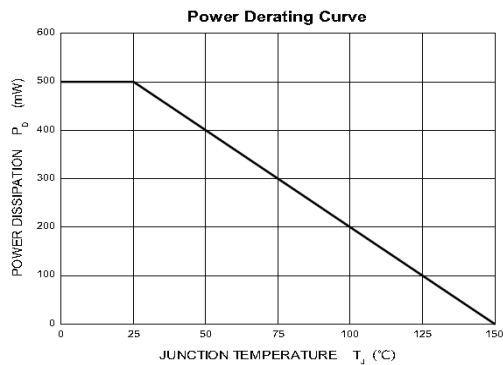
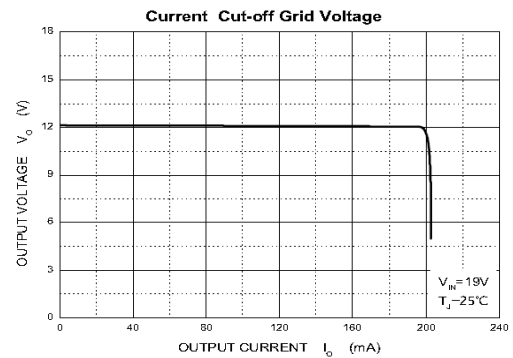
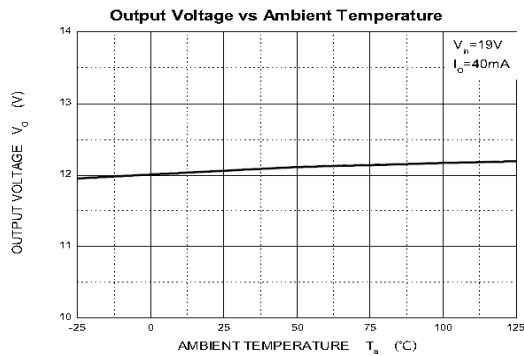
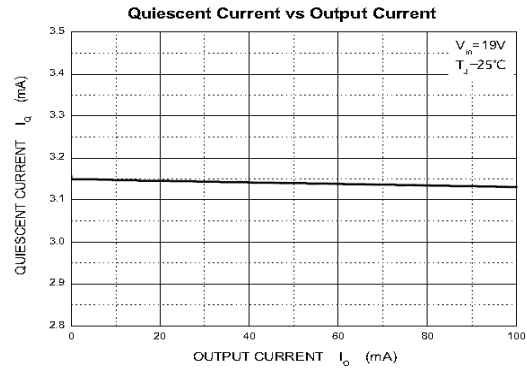
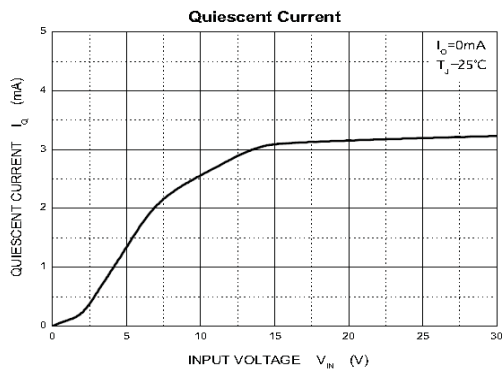
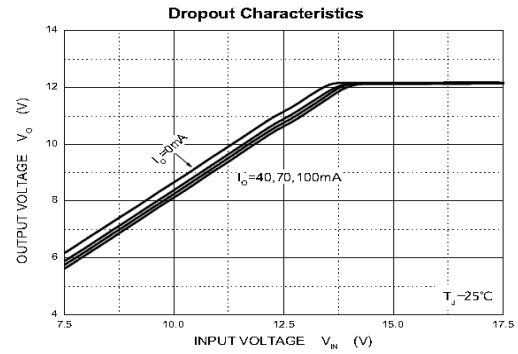
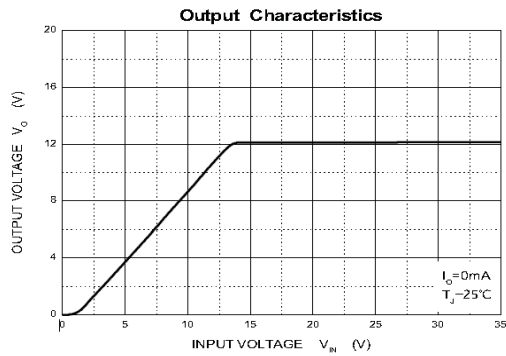

## SOT-89 PACKAGE OUTLINE

Unit: mm

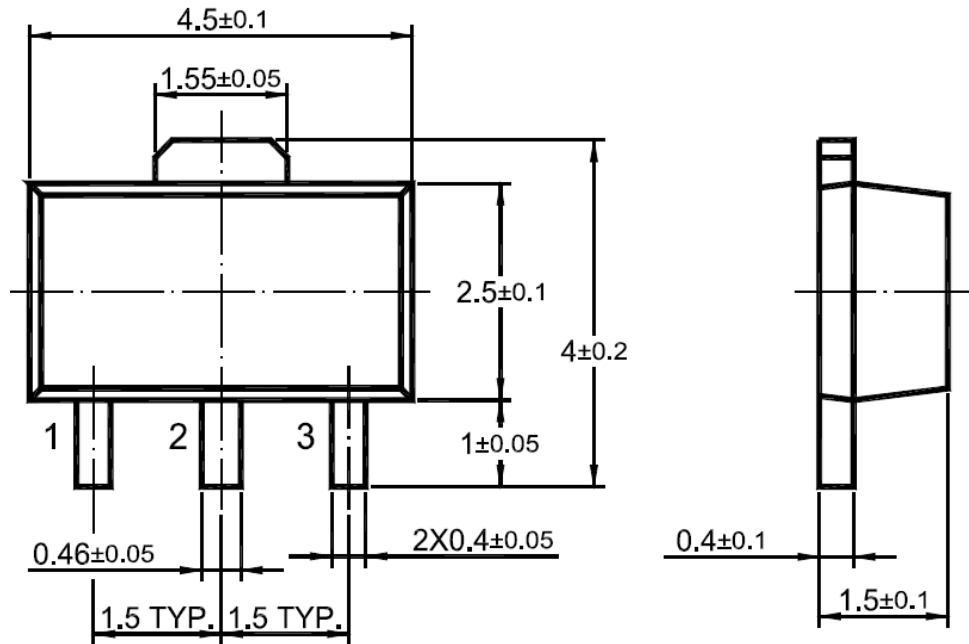

## X-ON Electronics

Largest Supplier of Electrical and Electronic Components

*Click to view similar products for [Linear Voltage Regulators](#) category:*

*Click to view products by [Shikues](#) manufacturer:*

Other Similar products are found below :

[LV5684PVD-XH](#) [MCDTSA6-2R](#) [L7815ACV-DG](#) [LV56801P-E](#) [UA7805CKC](#) [714954EB](#) [ZMR500QFTA](#) [BA033LBSG2-TR](#)

[NCV78M05ABDTRKG](#) [LV5680P-E](#) [L79M05T-E](#) [L78LR05D-MA-E](#) [NCV317MBTG](#) [NTE7227](#) [MP2018GZD-33-P](#) [MP2018GZD-5-P](#)

[LV5680NPVC-XH](#) [ZTS6538SE](#) [UA78L09CLP](#) [UA78L09CLPR](#) [CAT6221-PPTD-GT3](#) [MC78M09CDTRK](#) [NCV51190MNTAG](#)

[BL1118CS8TR1833](#) [BL8563CKETR18](#) [BL8077CKETR33](#) [BL9153-33CC3TR](#) [BL9161G-15BADRN](#) [BL9161G-28BADRN](#)

[BRCO7530MMC](#) [CJ7815B-TFN-ARG](#) [LM317C](#) [GM7333K](#) [GM7350K](#) [XC6206P332MR](#) [HT7533](#) [LM7912S/TR](#) [LT1764S/TR](#) [LM7805T](#)

[LM338T](#) [LM1117IMP-3.3/TR](#) [HT1117AM-3.3](#) [HT7550S](#) [AMS1117-3.3](#) [HT7150S](#) [78L12](#) [HT7550](#) [HT7533-1](#) [HXY6206I-2.5](#) [HT7133](#)