

SOT-23 Plastic-Encapsulate Transistors

PNP Darlingon Transistor

MARKING CODE: A63:2U

A64:2V

For general purpose application, darlington transistor

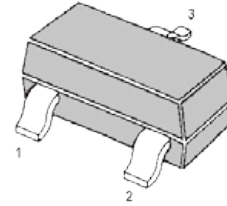

SOT-23

1. BASE 2. EMITTER 3. COLLECTOR

Absolute Maximum Ratings ($T_a = 25\text{ }^\circ\text{C}$)

Parameter	Symbol	Value	Unit
Collector Base Voltage	$-V_{CBO}$	30	V
Collector Emitter Voltage	$-V_{CEO}$	30	V
Emitter Base Voltage	$-V_{EBO}$	10	V
Collector Current	$-I_C$	500	mA
Power Dissipation	P_{tot}	200	mW
Junction Temperature	T_j	150	$^\circ\text{C}$
Storage Temperature Range	T_S	- 55 to + 150	$^\circ\text{C}$

Characteristics at $T_a = 25\text{ }^\circ\text{C}$

Parameter	Symbol	Min.	Max.	Unit
DC Current Gain				
at $-V_{CE} = 5\text{ V}$, $-I_C = 10\text{ mA}$	MMBTA63	h_{FE}	5000	-
at $-V_{CE} = 5\text{ V}$, $-I_C = 10\text{ mA}$	MMBTA64	h_{FE}	10000	-
at $-V_{CE} = 5\text{ V}$, $-I_C = 100\text{ mA}$	MMBTA63	h_{FE}	10000	-
at $-V_{CE} = 5\text{ V}$, $-I_C = 100\text{ mA}$	MMBTA64	h_{FE}	20000	-
Collector Cutoff Current at $-V_{CB} = 30\text{ V}$	$-I_{CBO}$	-	100	nA
Emitter Cutoff Current at $-V_{EB} = 10\text{ V}$	$-I_{EBO}$	-	100	nA
Collector Emitter Breakdown Voltage at $-I_C = 100\text{ }\mu\text{A}$	$-V_{(BR)CEO}$	30	-	V
Collector Emitter Saturation Voltage at $-I_C = 100\text{ mA}$, $-I_B = 0.1\text{ mA}$	$-V_{CE(sat)}$	-	1.5	V
Base Emitter On Voltage at $-V_{CE} = 5\text{ V}$, $-I_C = 100\text{ mA}$	$-V_{BE(on)}$	-	2	V
Transition Frequency at $-V_{CE} = 5\text{ V}$, $I_E = 10\text{ mA}$	f_T	125	-	MHz

Typical Characteristics

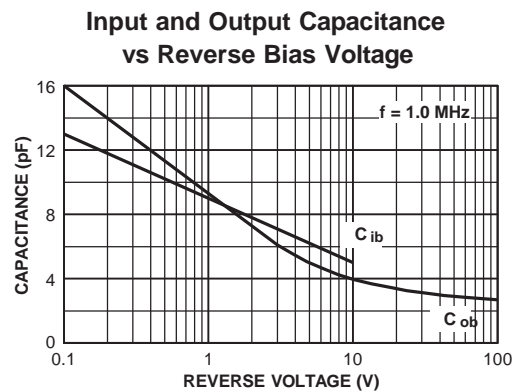
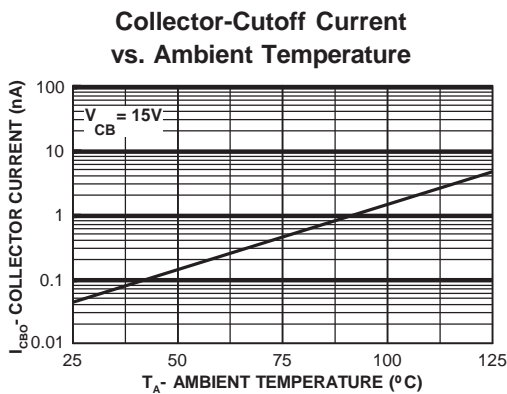
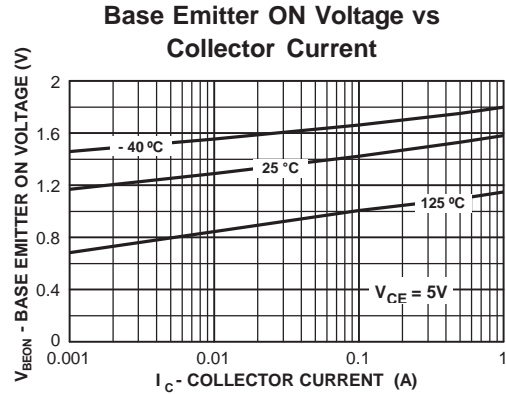
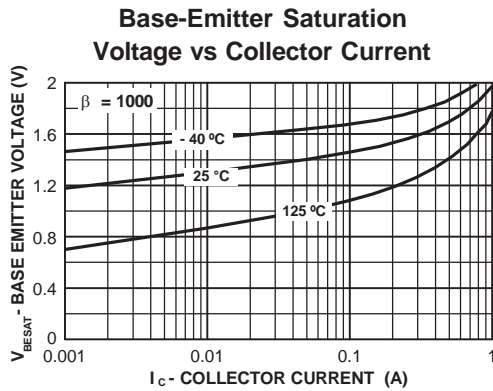
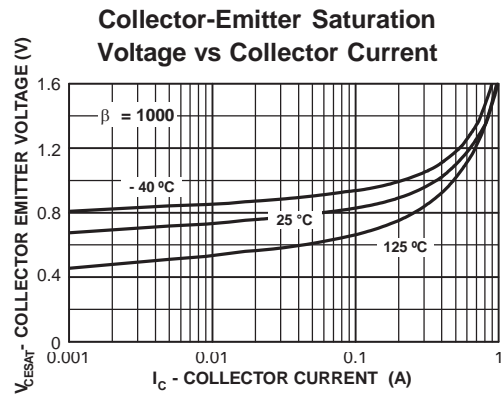
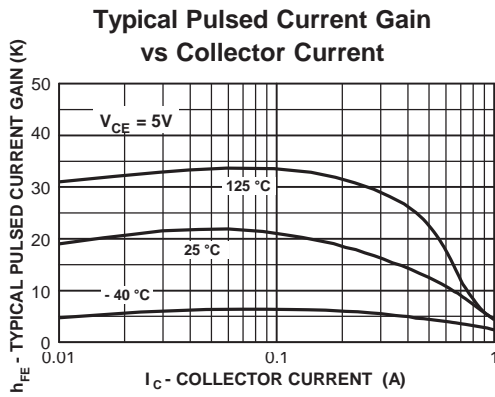

PACKAGE OUTLINE

Plastic surface mounted package; 3 leads

SOT-23

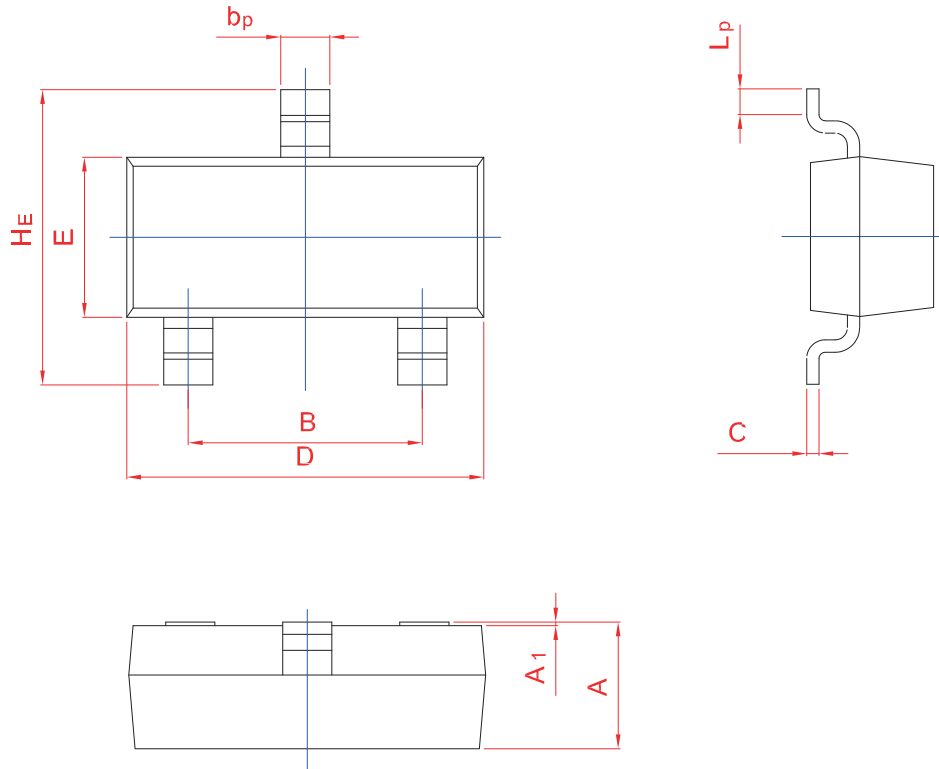

UNIT	A	B	b_p	C	D	E	H_E	A_1	L_p
mm	1.40	2.04	0.50	0.19	3.10	1.65	3.00	0.100	0.50
	0.95	1.78	0.35	0.08	2.70	1.20	2.20	0.013	0.20

X-ON Electronics

Largest Supplier of Electrical and Electronic Components

Click to view similar products for [Darlington Transistors](#) category:

Click to view products by [Shikues](#) manufacturer:

Other Similar products are found below :

[BDV64B](#) [SBSP52T1G](#) [Jantx2N6058](#) [LB1205-L-E](#) [2N6053](#) [MPSA63](#) [2N6667](#) [NTE256](#) [TIP120](#) [MJ11028](#) [TIP127](#) [Jantx2N6352](#)
[NJVBUB323ZT4G](#) [ULN2003](#) [ULN2803QN](#) [GN2003B](#) [MJD127T4G-JSM](#) [KID65004AF-EL/P](#) [ULN2803](#) [ULN2803CDWR](#) [HT62783ARTZ](#)
[ULN2803A](#) [GN2803A](#) [MC1413BM/TR](#) [ULN2003AN](#) [ULN2003LVM/TR](#) [HT1413ARZ](#) [ULN2803A](#) [ULN2003](#) [ULN2803](#) [IK62783N](#)
[IK62083N](#) [ULN2003AL](#) [MMBTA63](#) [ULN2001D](#) [ULN2004N](#) [ULN2003A](#) [2SB1560](#) [2SB852KT146B](#) [2SD2560](#) [TIP112TU](#) [BCV27](#)
[MMBTA13-TP](#) [MMBTA14-TP](#) [MMSTA28T146](#) [BSP50H6327XTSA1](#) [NTE2557](#) [NJVNJD35N04T4G](#) [MPSA29-D26Z](#) [MJD127T4](#)