

## Dual Common Anode Zener TVS

 Lead(Pb)-Free

### Features:

- \*Allows Either Two Separate Unidirectional Configurations or a Single Bidirectional Configurations.
- \*Low Leakage Current.
- \*24-40 Watts Peak Power Protection.
- \*Excellent Clamping Capability.
- \*ESD Rating of Class N(exceeding 16KV)per the Human Body Model.
- \*Transient Voltage Suppressors Encapsulated in a SOT-23 Package.

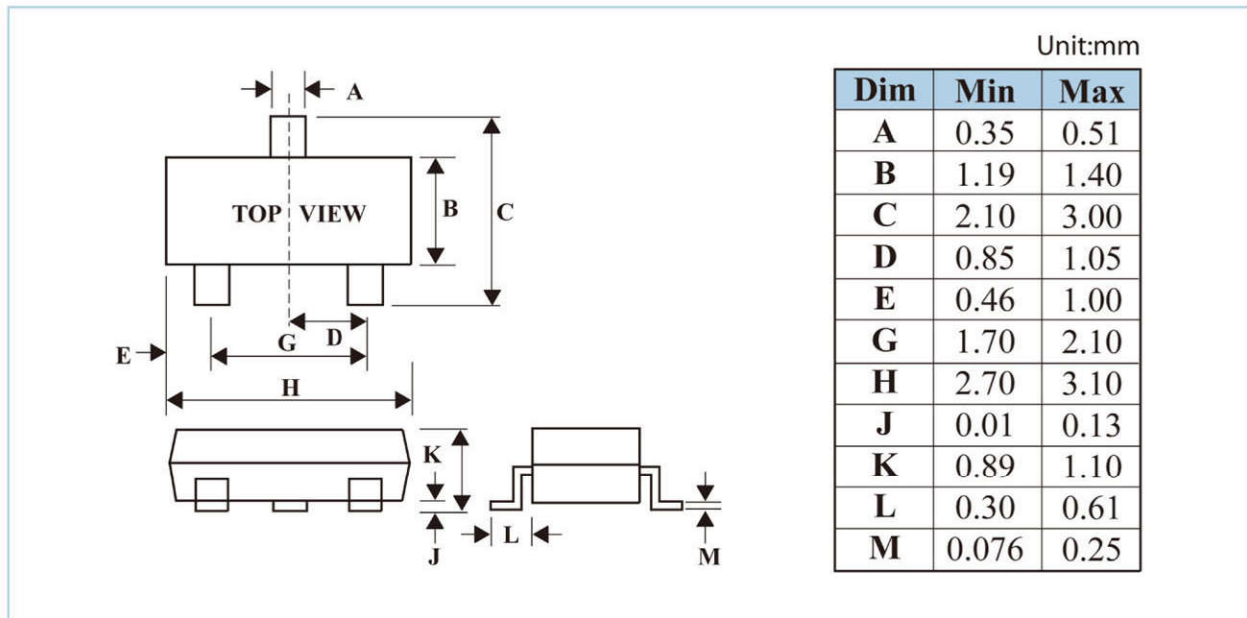
### Mechanical Data:

- \*Case: Molded Epoxy
- \*Marking: Marking Code
- \*Maximum Case Temperature for Soldering Purpose: 260 C for 10 sec.
- \*Weight: 0.008grams(approx.)

SMALL SIGNAL  
ZENER DIODES  
300m WATTS  
3-26 VOLTS



## SOT-23 Outline Dimensions



## Maximum Ratings (TA=25°C Unless otherwise Noted)

Characteristics	Symbol	Value	
Peak Power Dissipation @ 1.0 ms @ $T_L \leq 25^\circ\text{C}$ <sup>(1)</sup> MMBZ5V6A thru MMBZ10VA MMBZ12VA thru MMBZ33VA	P <sub>PK</sub>	24 40	W
Total Power Dissipation on FR-5 Board <sup>(2)</sup> @ TA=25°C Derate above 25°C	P <sub>D</sub>	225 1.8	mW mW/°C
Thermal Resistance Junction-to-Ambient	R <sub>θJA</sub>	556	°C/W
Total Power Dissipation on Alumina Substrate <sup>(3)</sup> @ TA =25°C Derate above 25°C	P <sub>D</sub>	300 2.4	mW mW/°C
Thermal Resistance Junction-to-Ambient	R <sub>θJA</sub>	417	°C/W
Junction and Storage Temperature Range	T <sub>J</sub> , T <sub>STG</sub>	-55 to +150	°C
Lead Solder Temperature-Maximum(10 Second Duration)	T <sub>L</sub>	260	°C

NOTE: 1. Non-Repetitive Current Pulse, per FIG 5 and Derated above TA=25°C per FIG 6.

2. FR-5=1.0×0.75×0.62 in.

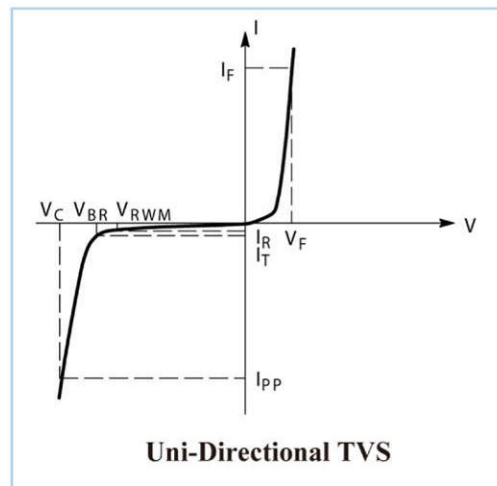
3. Alumina=0.4×0.3×0.024m, 99.5% alumina

## Electrical Characteristics

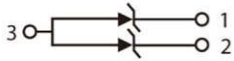
(TA=25°C unless otherwise noted)

**UNIDIRECTIONAL** (Circuit tied to Pins 1 and 3 or 2 and 3)

Symbol	Parameter
I <sub>PP</sub>	Maximum Reverse Peak Pulse Current
V <sub>C</sub>	Clamping Voltage @ I <sub>PP</sub>
V <sub>RWM</sub>	Working Peak Reverse Voltage
I <sub>R</sub>	Maximum Reverse Leakage Current @ V <sub>RWM</sub>
θV <sub>BR</sub>	Breakdown Voltage @ I <sub>T</sub>
I <sub>T</sub>	Test Current
V <sub>BR</sub>	Maximum Temperature Coefficient of V <sub>BR</sub>
I <sub>F</sub>	Forward Current
V <sub>F</sub>	Forward Voltage @ I <sub>F</sub>
Z <sub>ZT</sub>	Maximum Zener Impedance @ I <sub>ZT</sub>
I <sub>ZK</sub>	Reverse Current
Z <sub>ZK</sub>	Maximum Zener Impedance @ I <sub>ZK</sub>



## Device Marking

Item	Marking	Equivalent Circuit diagram
MMBZ5V6A Series	XX=Specific Device Code (See Table on Page 3)	



**ELECTRICAL CHARACTERISTICS** ( $T_A = 25^\circ\text{C}$  unless otherwise noted)

**UNIDIRECTIONAL** (Circuit tied to Pins 1 and 3 or Pins 2 and 3)

( $V_F = 0.9\text{ V Max @ } I_F = 10\text{ mA}$ )

**24 WATTS**

Device	Device Marking	$V_{RWM}$ Volts	$I_R @ V_{RWM}$ uA	Breakdown Voltage			@ $I_T$ mA	Max Zener Impedance <sup>(5)</sup>			$V_C @ I_{PP}$ <sup>(6)</sup>		$\theta V_{BR}$ mV/°C
				$V_{BR}^{(4)}$ (V)				$Z_{ZT}$ @ $I_{ZT}$	$Z_{ZK}$ @ $I_{ZK}$	$V_C$	$I_{PP}$		
				Min	Nom	Max		$\Omega$	$\Omega$	V	A		
MMBZ5V6A	5A6	3.0	5.0	5.32	5.6	5.88	20	11	1600	0.25	8.0	3.0	1.26
MMBZ6V2A	6A2	3.0	0.5	5.89	6.2	6.51	1.0	-	-	-	8.7	2.76	2.80
MMBZ6V8A	6A8	4.5	0.5	6.46	6.8	7.14	1.0	-	-	-	9.6	2.5	3.4
MMBZ9V1A	9A1	6.0	0.3	8.65	9.1	9.56	1.0	-	-	-	14	1.7	7.5
MMBZ10VA	10A	6.5	0.3	9.50	10	10.5	1.0	-	-	-	14.2	1.7	7.5

( $V_F = 0.9\text{ V Max @ } I_F = 10\text{ mA}$ )

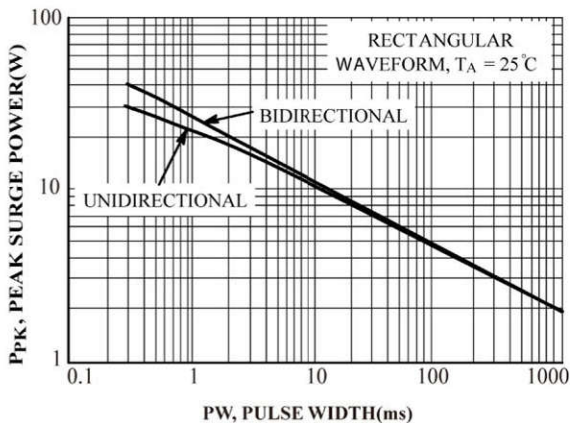
**40 WATTS**

Device	Device Marking	$V_{RWM}$ Volts	$I_R @ V_{RWM}$ nA	Breakdown Voltage			@ $I_T$ mA	$V_C @ I_{PP}^{(6)}$		$\theta V_{BR}$ mV/°C
				$V_{BR}^{(4)}$ (V)				$V_C$	$I_{PP}$	
				Min	Nom	Max		V	A	
MMBZ12VA	12A	8.5	200	11.40	12	12.60	1.0	17	2.35	7.5
MMBZ15VA	15A	12	50	14.25	15	15.75	1.0	21	1.9	12.3
MMBZ18VA	18A	14.5	50	17.10	18	18.90	1.0	25	1.6	15.3
MMBZ20VA	20A	17	50	19.00	20	21.00	1.0	28	1.4	17.2
MMBZ27VA	27A	22	50	25.65	27	28.35	1.0	40	1.0	24.3
MMBZ33VA	33A	26	50	31.35	33	34.65	1.0	46	0.87	30.4

4.  $V_{BR}$  measured at pulse test current  $I_T$  at an ambient temperature of  $25^\circ\text{C}$ .

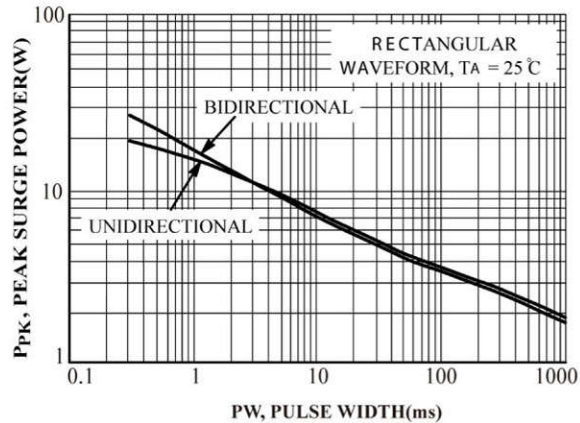
5.  $Z_{ZT}$  and  $Z_{ZK}$  are measured by dividing the AC voltage drop across the device by the AC current applied. The specified limits are for  $I_{Z(AC)} = 0.1 I_{Z(DC)}$ , with the AC frequency = 1.0 kHz.

6. Surge current waveform per Fig 5 and derate per Fig 6



**FIG.7 Maximum Non-repetitive Surge Power,  $P_{PK}$  Versus PW**

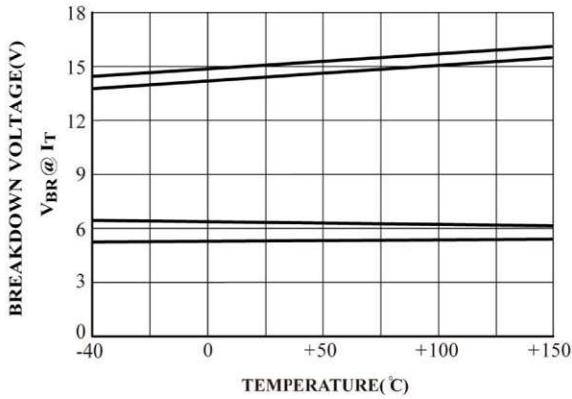
Power is defined as  $V_{RSM} \times I_{Z(pk)}$  where  $V_{RSM}$  is the clamping voltage at  $I_{Z(pk)}$ .



**FIG.8 Maximum Non-repetitive Surge Power,  $P_{PK(NOM)}$  Versus PW**

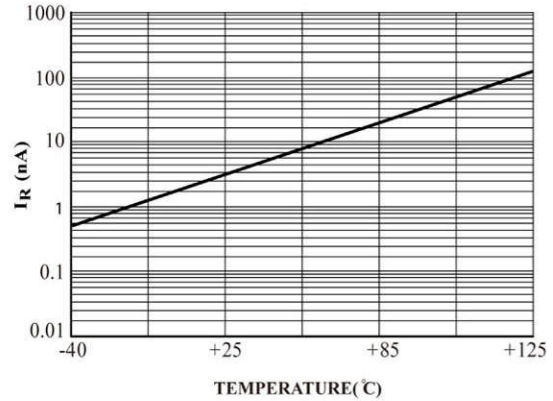
Power is defined as  $V_Z (NOM) \times I_{Z(pk)}$  where  $V_Z (NOM)$  is the nominal Zener voltage measured at the low test current used for voltage classification



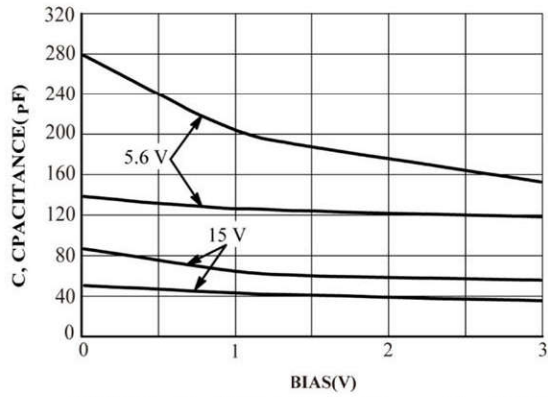


**FIG.1 Typical Breakdown Voltage Versus Temperature**

(Upper curve for each voltage is bidirectional mode,  
lower curve is unidirectional mode)

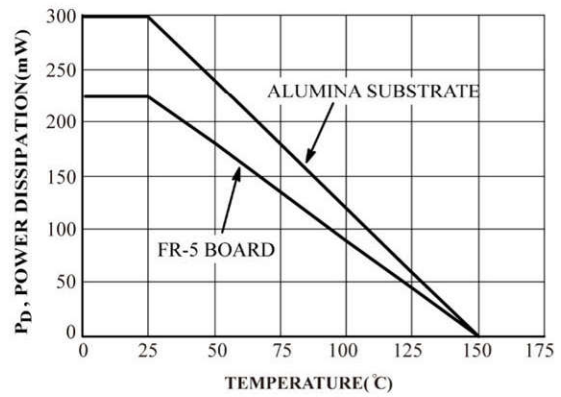


**FIG.2 Typical Leakage Current Versus Temperature**

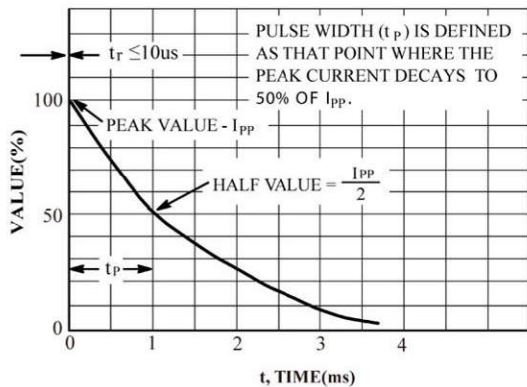


**FIG.3 Typical Capacitance Versus Bias Voltage**

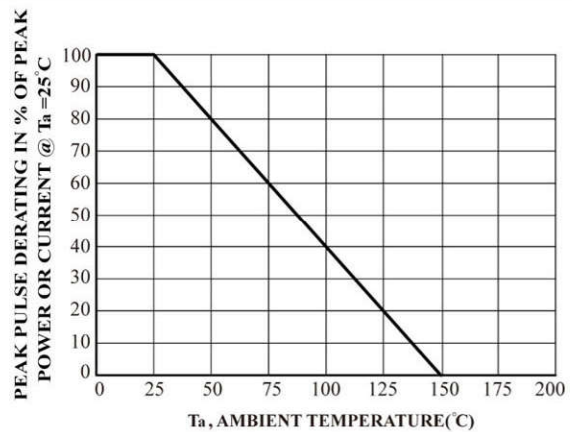
(Upper curve for each voltage is bidirectional mode,  
lower curve is unidirectional mode)



**FIG.4 Steady State Power Derating Curve**



**FIG.5 Pulse Waveform**



**FIG.6 Pulse Derating Curve**



## X-ON Electronics

Largest Supplier of Electrical and Electronic Components

*Click to view similar products for [ESD Suppressors / TVS Diodes](#) category:*

*Click to view products by [Shikues](#) manufacturer:*

Other Similar products are found below :

[60KS200C](#) [D18V0L1B2LP-7B](#) [D5V0F4U5P5-7](#) [DESD5V0U1BB-7](#) [NTE4902](#) [P4KE27CA](#) [P6KE11CA](#) [P6KE39CA-TP](#) [P6KE8.2A](#)  
[SA110CA](#) [SA60CA](#) [SA64CA](#) [SMBJ12CATR](#) [SMBJ33CATR](#) [SMBJ8.0A](#) [ESD101-B1-02ELS E6327](#) [ESD105-B1-02EL E6327](#) [ESD112-B1-02EL E6327](#) [ESD119B1W01005E6327XTSA1](#) [ESD5V0L1B02VH6327XTSA1](#) [ESD7451N2T5G](#) [19180-510](#) [CPDT-5V0USP-HF](#)  
[3.0SMCJ33CA-F](#) [3.0SMCJ36A-F](#) [HSPC16701B02TP](#) [D3V3Q1B2DLP3-7](#) [D55V0M1B2WS-7](#) [DESD5V0U1BL-7B](#) [DRTR5V0U4SL-7](#)  
[SCM1293A-04SO](#) [ESD200-B1-CSP0201 E6327](#) [SM12-7](#) [SMF8.0A-TP](#) [SMLJ45CA-TP](#) [CEN955 W/DATA](#) [82350120560](#) [VESD12A1A-](#)  
[HD1-GS08](#) [CPDUR5V0R-HF](#) [CPDQC5V0U-HF](#) [CPDQC5V0USP-HF](#) [CPDQC5V0-HF](#) [D1213A-01LP4-7B](#) [D1213A-02WL-7](#)  
[MMAD1108/TR13](#) [5KP100A](#) [5KP15A](#) [5KP18A](#) [5KP48A](#) [5KP90A](#)