

Surface mount transient voltage suppressor power 600 watts

Stand-Off Voltage : 6.8V~550V

FEATURES

- For surface mounted applications in order to optimize board space.
- Low profile package
- Glass passivated junction
- Low inductance
- Plastic package has Underwriters Laboratory Flammability

MECHANICAL DATA

- Case: SMB
- Terminals: Solderable per MIL-STD-750, Method 2026
- Approx. Weight: 0.055g / 0.002oz

PINNING

PIN	DESCRIPTION
1	Cathode
2	Anode

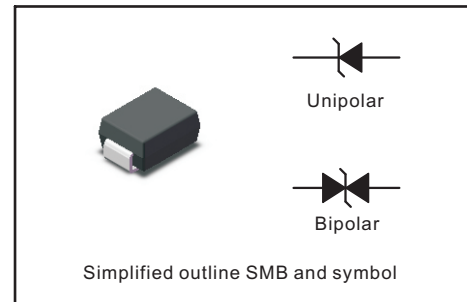

Maximum Ratings and Electrical characteristics

Ratings at 25 °C ambient temperature unless otherwise specified.

Parameter	Symbol	Value	Unit
Peak Pulse Power Dissipation on 10/1000 s waveform (Note1,Note2, Fig.1).	P_{PPM}	600	W
Peak Forward Surge Current,8.3ms Single Half Sine-Wave Superimposed on Rated Load, (JEDEC Method) (Note 3, Fig4).	I_{FSM} (UNI)	100	A
Peak Pulse Current on 10/1000 us waveform (Note 1, Fig 3)	I_{PPM}	see Table 1	A
Typical Junction capacitance at VR=4V, f=1MHz	C_J	390	pF
ESD Voltage per IEC6100-4-2	V_{ESD1} V_{ESD2}	± 30 ± 30	kV
Typical Thermal Resistance Junction to Ambient(Note 2)	$R_{\theta JA}$	100	°C/W
Operating Junction Temperature and Storage Temperature Range	T_j, T_{stg}	-65 ~ +150	°C

NOTES:

1. Non-repetitive current pulse, per Fig.3 and derated above $T_A = 25^\circ\text{C}$ per Fig. 2.
2. Mounted on 5 mm² (0.13mm thick) land areas.
3. Measured on 8.3ms, single half sine-wave or equivalent square wave, duty cycle=4 pulses per minute maximum.
4. Peak pulse power waveform is 10/1000μS.

Type		Reverse Stand-off Voltage	Breakdown Voltage		Test Current	Maximum Reverse Leakage	Max. Clamp Voltage	Peak Pulse Current	Package	
			V _{BR} @ I _T						SMB	
		V _{RMW}	Min	Max	I _T	V _C @ I _{PP}	I _{PP}	Device Marking Code	UNI	BI
UNI	BI	V	V	V	mA	µA	V	A	UNI	BI
600W Transient Voltage Suppressors										
P6SMB6.8A	P6SMB6.8CA	5.8	6.45	7.14	10	1000	10.5	58.1	6V8A	6V8C
P6SMB7.5A	P6SMB7.5CA	6.4	7.13	7.88	10	500	11.3	54	7V5A	7V5C
P6SMB8.2A	P6SMB8.2CA	7.02	7.79	8.61	10	200	12.1	50.4	8V2A	8V2C
P6SMB9.1A	P6SMB9.1CA	7.78	8.65	9.55	1	50	13.4	45.5	9V1A	9V1C
P6SMB10A	P6SMB10CA	8.55	9.5	10.5	1	10	14.5	42.1	10A	10C
P6SMB11A	P6SMB11CA	9.4	10.5	11.6	1	5	15.6	39.1	11A	11C
P6SMB12A	P6SMB12CA	10.2	11.4	12.6	1	5	16.7	36.5	12A	12C
P6SMB13A	P6SMB13CA	11.1	12.4	13.7	1	1	18.2	33.5	13A	13C
P6SMB15A	P6SMB15CA	12.8	14.3	15.8	1	1	21.2	28.8	15A	15C
P6SMB16A	P6SMB16CA	13.6	15.2	16.8	1	1	22.5	27.1	16A	16C
P6SMB18A	P6SMB18CA	15.3	17.1	18.9	1	1	25.5	24.2	18A	18C
P6SMB20A	P6SMB20CA	17.1	19	21	1	1	27.7	22	20A	20C
P6SMB22A	P6SMB22CA	18.8	20.9	23.1	1	1	30.6	19.9	22A	22C
P6SMB24A	P6SMB24CA	20.5	22.8	25.2	1	1	33.2	18.4	24A	24C
P6SMB27A	P6SMB27CA	23.1	25.7	28.4	1	1	37.5	16.3	27A	27C
P6SMB30A	P6SMB30CA	25.6	28.5	31.5	1	1	41.4	14.7	30A	30C
P6SMB33A	P6SMB33CA	28.2	31.4	34.7	1	1	45.7	13.3	33A	33C
P6SMB36A	P6SMB36CA	30.8	34.2	37.8	1	1	49.9	12.2	36A	36C
P6SMB39A	P6SMB39CA	33.3	37.1	41	1	1	53.9	11.3	39A	39C
P6SMB43A	P6SMB43CA	36.8	40.9	45.2	1	1	59.3	10.3	43A	43C
P6SMB47A	P6SMB47CA	40.2	44.7	49.4	1	1	64.8	9.4	47A	47C
P6SMB51A	P6SMB51CA	43.6	48.5	53.6	1	1	70.1	8.7	51A	51C
P6SMB56A	P6SMB56CA	47.8	53.2	58.8	1	1	77	7.9	56A	56C
P6SMB58A	P6SMB58CA	52.78	55.1	60.9	1	1	79.8	7.7	58A	58C
P6SMB62A	P6SMB62CA	53	58.9	65.1	1	1	85	7.2	62A	62C
P6SMB68A	P6SMB68CA	58.1	64.6	71.4	1	1	92	6.6	68A	68C
P6SMB75A	P6SMB75CA	64.1	71.3	78.8	1	1	103	5.9	75A	75C
P6SMB82A	P6SMB82CA	70.1	77.9	86.1	1	1	113	5.4	82A	82C
P6SMB91A	P6SMB91CA	77.8	86.5	95.5	1	1	125	4.9	91A	91C
P6SMB100A	P6SMB100CA	85.5	95	105	1	1	137	4.5	100A	100C
P6SMB110A	P6SMB110CA	94	105	116	1	1	152	4	110A	110C
P6SMB120A	P6SMB120CA	102	114	126	1	1	165	3.7	120A	120C
P6SMB130A	P6SMB130CA	111	124	137	1	1	179	3.4	130A	130C
P6SMB150A	P6SMB150CA	128	143	158	1	1	207	2.9	150A	150C
P6SMB160A	P6SMB160CA	136	152	168	1	1	219	2.8	160A	160C
P6SMB170A	P6SMB170CA	145	162	179	1	1	234	2.6	170A	170C
P6SMB180A	P6SMB180CA	154	171	189	1	1	246	2.5	180A	180C
P6SMB200A	P6SMB200CA	171	190	210	1	1	274	2.2	200A	200C
P6SMB220A	P6SMB220CA	185	209	231	1	1	328	1.9	220A	220C
P6SMB250A	P6SMB250CA	214	237	263	1	1	344	1.8	250A	250C
P6SMB300A	P6SMB300CA	256	285	315	1	1	414	1.5	300A	300C
P6SMB350A	P6SMB350CA	300	332	368	1	1	482	1.3	350A	350C
P6SMB400A	P6SMB400CA	342	380	420	1	1	548	1.1	400A	400C
P6SMB440A	P6SMB440CA	376	418	462	1	1	602	1	440A	440C
P6SMB480A	P6SMB480CA	408	456	504	1	1	658	0.9	480A	480C
P6SMB510A	P6SMB510CA	434	485	535	1	1	698	0.9	510A	510C
P6SMB530A	P6SMB530CA	451	503.5	556.5	1	1	725	0.8	530A	530C
P6SMB540A	P6SMB540CA	460	513	567	1	1	740	0.8	540A	540C
P6SMB550A	P6SMB550CA	468	522.5	577.5	1	1	760	0.8	550A	550C

Fig.1 Peak Pulse Power Rating Curve

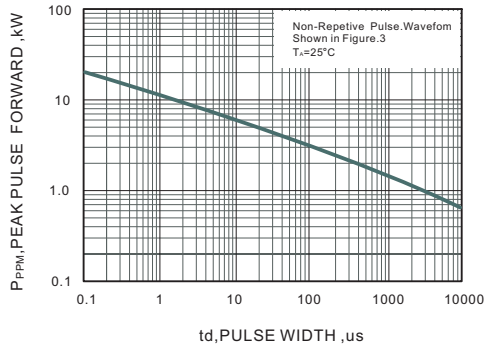

Fig.2 Forward Current Derating Curve

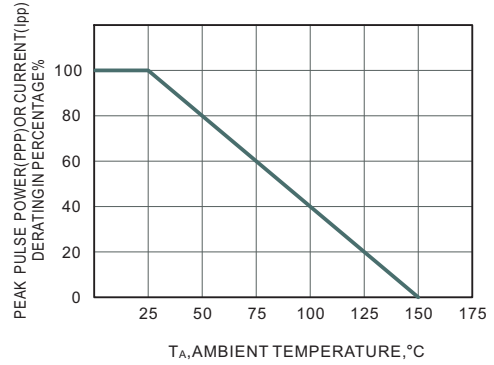

Fig.3 Pulse Waveform

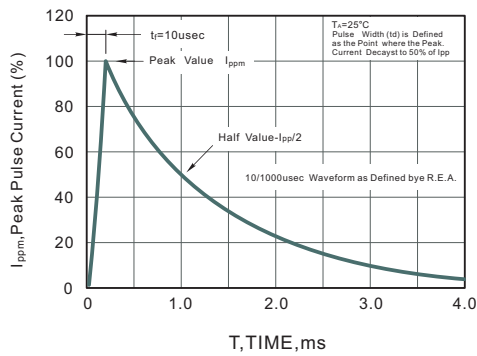
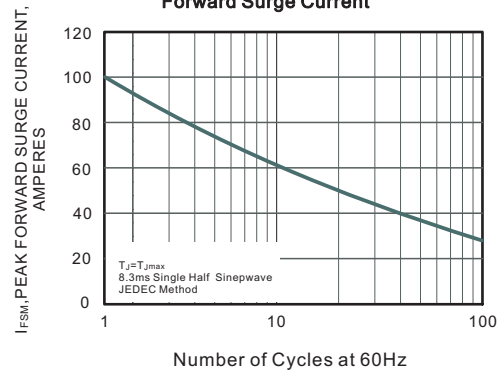

Fig.4 Maximum Non-Repetitive Peak Forward Surge Current



PACKAGE OUTLINE

Plastic surface mounted package; 2 leads

SMB

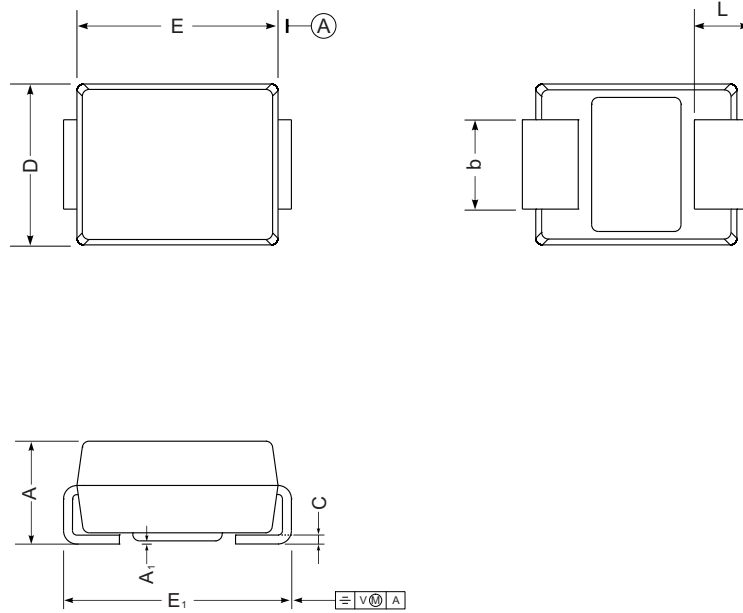

SMB mechanical data

UNIT		A	E	D	E ₁	A ₁	L	C	b
mm	max	2.44	4.70	3.94	5.59	0.20	1.5	0.305	2.11
	min	2.13	4.06	3.3	5.08	0.05	0.8	0.152	1.91
mil	max	96	185	155	220	7.9	59	12	83
	min	84	160	130	200	2.0	32	6	75

The recommended mounting pad size

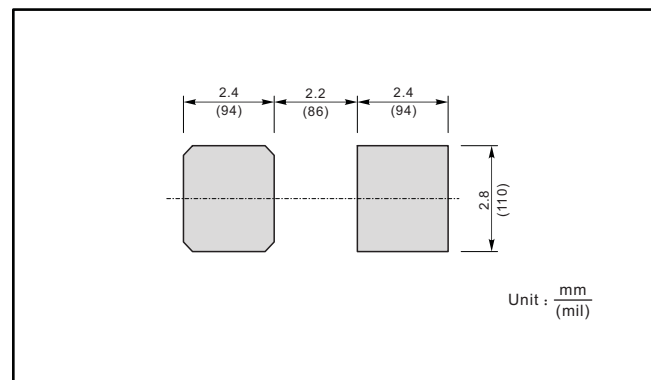

X-ON Electronics

Largest Supplier of Electrical and Electronic Components

Click to view similar products for [ESD Suppressors / TVS Diodes](#) category:

Click to view products by [Shikues](#) manufacturer:

Other Similar products are found below :

[60KS200C](#) [D18V0L1B2LP-7B](#) [D5V0F4U5P5-7](#) [NTE4902](#) [P4KE27CA](#) [P6KE11CA](#) [P6KE8.2A](#) [SA60CA](#) [SA64CA](#) [SMBJ12CATR](#)
[SMBJ33CATR](#) [SMBJ6.5A](#) [SMBJ8.0A](#) [ESD101-B1-02ELS](#) [E6327](#) [ESD112-B1-02EL](#) [E6327](#) [ESD7451N2T5G](#) [19180-510](#) [CPDT-5V0USP-](#)
[HF](#) [3.0SMCJ33CA-F](#) [3.0SMCJ36A-F](#) [HSPC16701B02TP](#) [JANTX1N6126A](#) [D3V3Q1B2DLP3-7](#) [D55V0M1B2WS-7](#) [SCM1293A-04SO](#)
[ESD200-B1-CSP0201](#) [E6327](#) [SM12-7](#) [CEN955](#) [W/DATA](#) [VESD12A1A-HD1-GS08](#) [CPDQC5V0-HF](#) [D1213A-01LP4-7B](#) [ESD101-B1-02EL](#)
[E6327](#) [AOZ8808DI-03](#) [5KP15A](#) [5KP48A](#) [5KP90A](#) [ESD3V3D7-TP](#) [15KPA36A-LF](#) [P4KE56CA](#) [P4KE68A](#) [P4KE91CATR](#) [P6KE120A](#)
[P6KE13CA](#) [P6KE43CA](#) [P6KE6.8CA](#) [P6KE8.2](#) [P6SMBJ20CA](#) [JANTX1N6072A](#) [SR2835ESKG](#) [SA90CA](#)