

P-Channel Enhancement Mode Field Effect Transistor

Product Summary

- V_{DS} -20V
- I_D -3.4A
- $R_{DS(ON)}$ (at $V_{GS}=-4.5V$) <64 mohm
- $R_{DS(ON)}$ (at $V_{GS}=-2.5V$) <80 mohm
- $R_{DS(ON)}$ (at $V_{GS}=-1.8V$) <95 mohm

General Description

- Trench Power LV MOSFET technology
- High Power and Current handling capability
- Low Gate Charge
- Marking : Δ 1SHB

Applications

- PWM applications
- Power management
- Load switch

SC-59

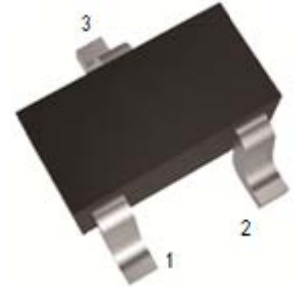
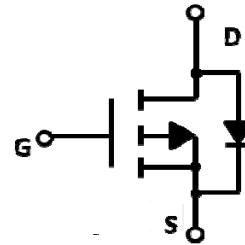

1 : Gate 2 : Source 3 : Drain

Absolute Maximum Ratings ($T_A=25^\circ\text{C}$ unless otherwise noted)

Parameter		Symbol	Maximum	Unit
Drain-source Voltage		V_{DS}	-20	V
Gate-source Voltage		V_{GS}	± 10	V
Drain Current	$T_A=25^\circ\text{C}$	I_D	-3.4	A
	$T_A=70^\circ\text{C}$		-2.7	
Pulsed Drain Current ^A		I_{DM}	-14	A
Total Power Dissipation @ $T_A=25^\circ\text{C}$		P_D	1	W
Thermal Resistance Junction-to-Ambient ^B		$R_{\theta JA}$	125	$^\circ\text{C}/\text{W}$
Junction and Storage Temperature Range		T_J, T_{STG}	-55 ~ +150	$^\circ\text{C}$

Electrical Characteristics ($T_J=25^\circ\text{C}$ unless otherwise noted)

Parameter	Symbol	Conditions	Min	Typ	Max	Units
Static Parameter						
Drain-Source Breakdown Voltage	BV_{DSS}	$V_{GS}=0V, I_D=-250\mu A$	-20			V
Zero Gate Voltage Drain Current	I_{DSS}	$V_{DS}=-20V, V_{GS}=0V, T_C=25^\circ\text{C}$			-1	μA
Gate-Body Leakage Current	I_{GSS}	$V_{GS}=\pm 10V, V_{DS}=0V$			± 100	nA
Gate Threshold Voltage	$V_{GS(th)}$	$V_{DS}=V_{GS}, I_D=-250\mu A$	-0.4	-0.62	-1.0	V
Static Drain-Source On-Resistance	$R_{DS(on)}$	$V_{GS}=-4.5V, I_D=-3.4A$		49	64	m Ω
		$V_{GS}=-2.5V, I_D=-3A$		59	80	
		$V_{GS}=-1.8V, I_D=-2.5A$		79	95	
Diode Forward Voltage	V_{SD}	$I_S=-3.4A, V_{GS}=0V$		-0.8	-1.2	V
Maximum Body-Diode Continuous Current	I_S				-3.4	A
Dynamic Parameters						
Input Capacitance	C_{iss}	$V_{DS}=-10V, V_{GS}=0V, f=1\text{MHz}$		550		pF
Output Capacitance	C_{oss}			89		
Reverse Transfer Capacitance	C_{rss}			65		
Switching Parameters						
Total Gate Charge	Q_g	$V_{GS}=-4.5V, V_{DS}=-10V, I_D=-3.4A$		4.3		nC
Gate Source Charge	Q_{gs}			0.8		
Gate Drain Charge	Q_{gd}			1.1		
Turn-on Delay Time	$t_{D(on)}$	$V_{GS}=-4.5V, V_{DD}=-10V, I_D=-1A, R_{GEN}=2.5\Omega$		12		ns
Turn-on Rise Time	t_r			54		
Turn-off Delay Time	$t_{D(off)}$			15		
Turn-off Fall Time	t_f			9		

A. Pulse Test: Pulse Width $\leq 300\mu s$, Duty cycle $\leq 2\%$.

B. Device mounted on FR-4 PCB, 1 inch x 0.85 inch x 0.062 inch.

Typical Performance Characteristics

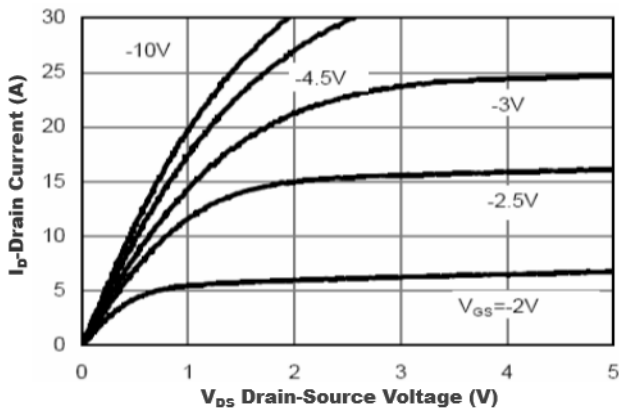

Figure1. Output Characteristics

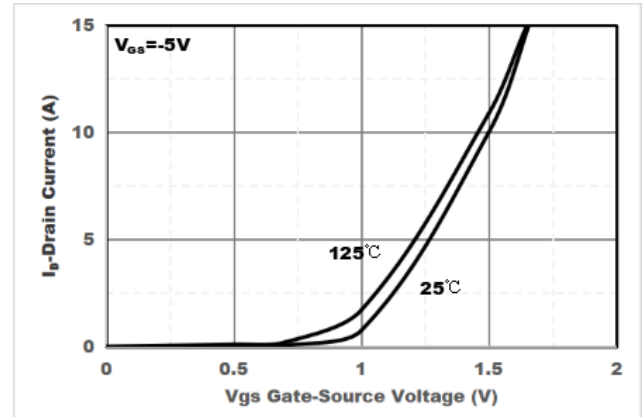

Figure2. Transfer Characteristics

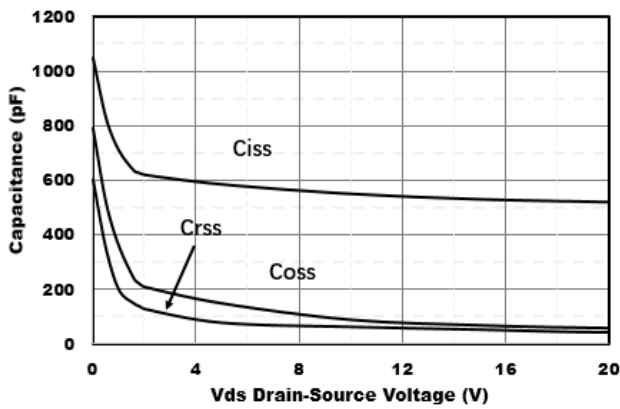

Figure3. Capacitance Characteristics

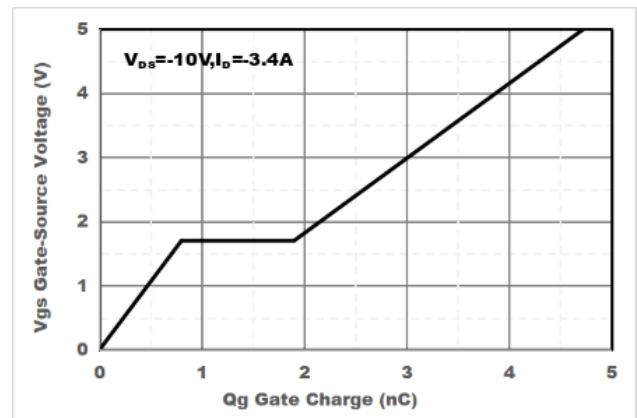

Figure4. Gate Charge

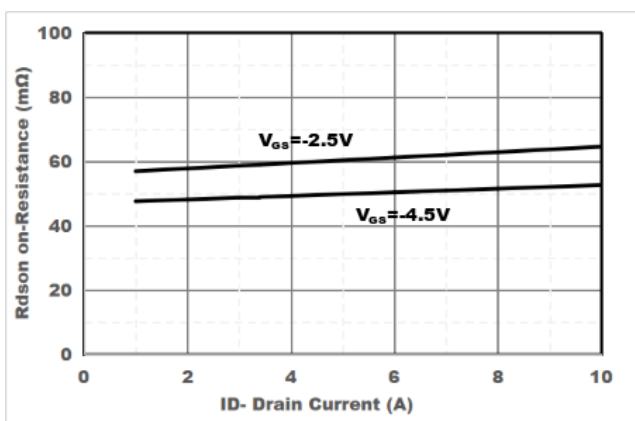

Figure5. Drain-Source on Resistance

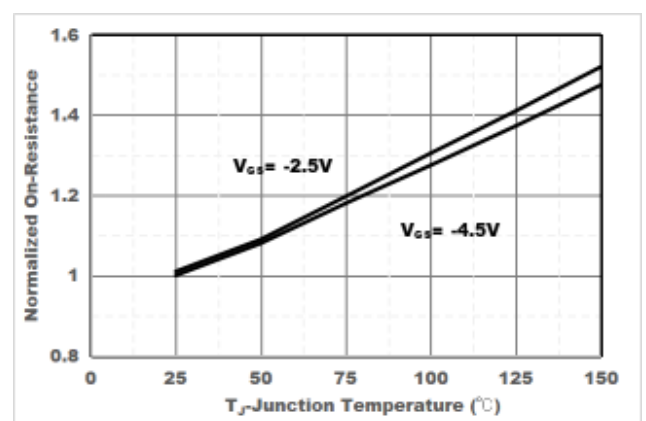

Figure6. Drain-Source on Resistance

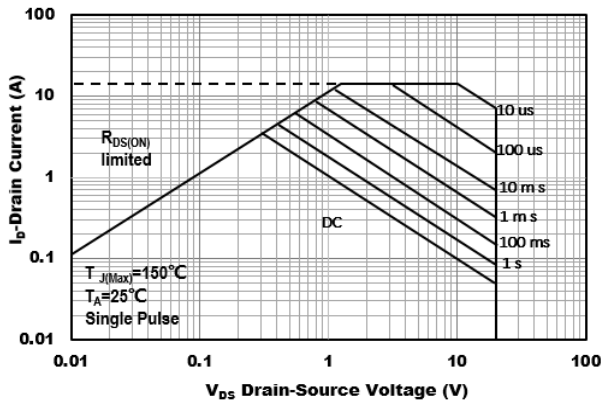

Figure7. Safe Operation Area

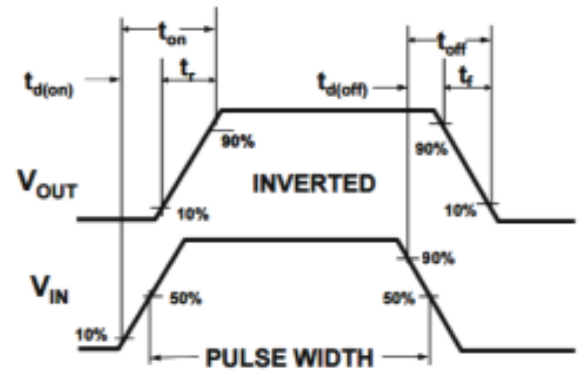
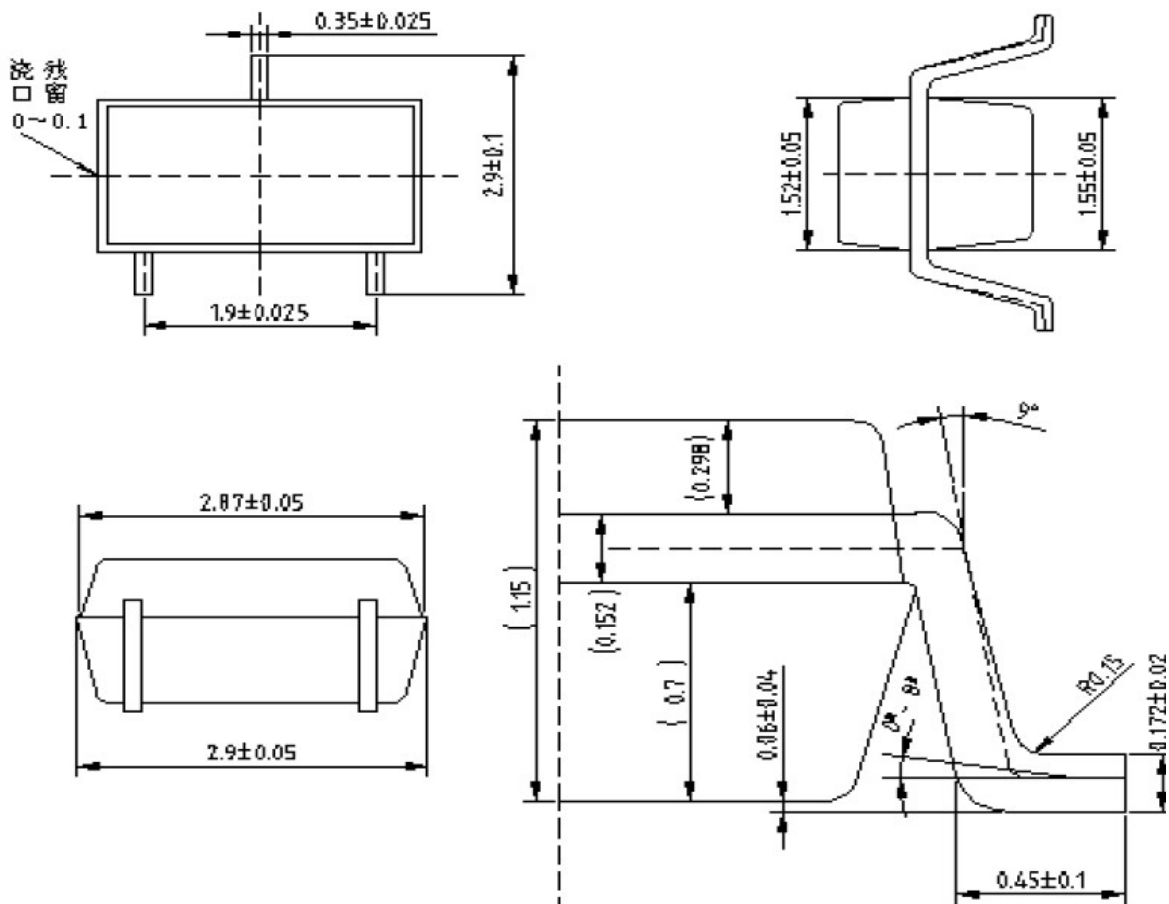

Figure8. Switching wave

Package Outline Dimensions (UNIT: mm)

SC-59



X-ON Electronics

Largest Supplier of Electrical and Electronic Components

Click to view similar products for [MOSFET](#) category:

Click to view products by [Shikues](#) manufacturer:

Other Similar products are found below :

[MCH3443-TL-E](#) [MCH6422-TL-E](#) [NTNS3A92PZT5G](#) [IRFD120](#) [JANTX2N5237](#) [2N7000](#) [2SK2464-TL-E](#) [2SJ277-DL-E](#) [2SK2267\(Q\)](#)
[2SK2545\(Q,T\)](#) [405094E](#) [423220D](#) [MIC4420CM-TR](#) [VN1206L](#) [614234A](#) [715780A](#) [SSM6J414TU,LF\(T](#) [751625C](#) [IRS2092STRPBF-EL](#)
[IPS70R2K0CEAKMA1](#) [BSF024N03LT3 G](#) [PSMN4R2-30MLD](#) [TK31J60W5,S1VQ\(O](#) [2SK2614\(TE16L1,Q\)](#) [DMN1017UCP3-7](#)
[EFC2J004NUZTDG](#) [P85W28HP2F-7071](#) [DMN1053UCP4-7](#) [SQJ469EP-T1-GE3](#) [NTE2384](#) [NTE6400A](#) [DMC2700UDMQ-7](#)
[DMN2080UCB4-7](#) [DMN61D9UWQ-13](#) [US6M2GTR](#) [DMN31D5UDJ-7](#) [SSM6P54TU,LF](#) [DMP22D4UFO-7B](#) [IPS60R3K4CEAKMA1](#)
[DMN1006UCA6-7](#) [DMN16M9UCA6-7](#) [STF5N65M6](#) [IRF40H233XTMA1](#) [IPSA70R950CEAKMA1](#) [IPSA70R2K0CEAKMA1](#) [STU5N65M6](#)
[C3M0021120D](#) [DMN6022SSD-13](#) [DMN13M9UCA6-7](#) [MCQ4828A-TP](#)